

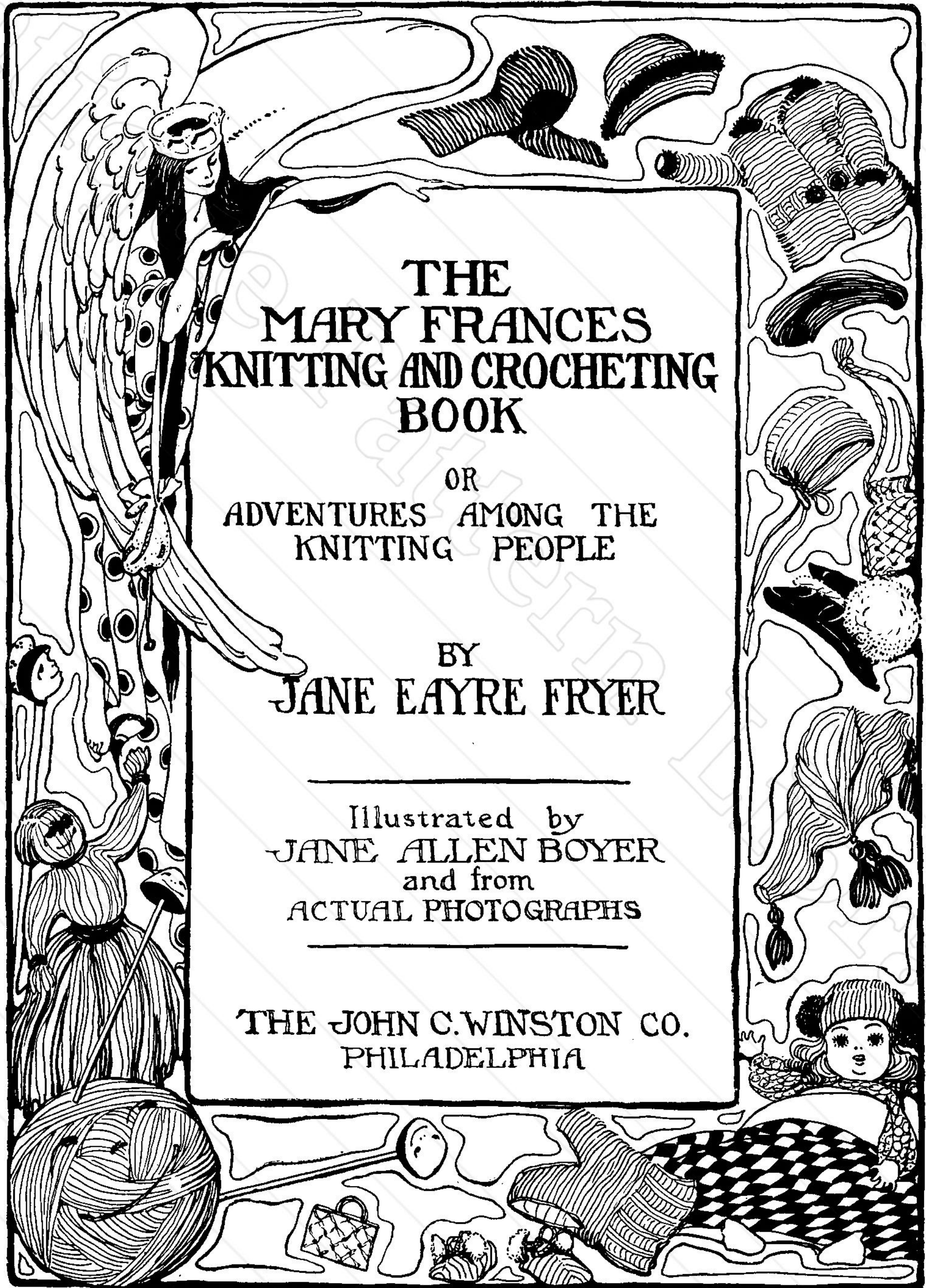



SEE MY NEW SWEATER

FOR DIRECTIONS FOR MAKING KNITTED ARTICLES SHOWN IN THIS ILLUSTRATION SEE
KNITTED SLEEVELESS SWEATER—185 CROCHETED HAT—206
CROCHETED SPORTS SWEATER—243



**COPYRIGHT, 1918, BY
JANE EAYRE FRYER**

CAUTION

The entire contents of this book are protected by copyright, and all persons are warned not to reproduce the text, in whole or in part, or any of the illustrations without permission of the publishers.



DEAR GIRLS:

After reading about Mary Frances' many adventures among the Kitchen People, and the Thimble People, and the Garden People, and with the Doll Family and the Brave Family, in the Mary Frances books—perhaps you thought that no girl, not even Mary Frances, could find any more funny little fairy helpers right in her own home.

But Mary Frances did, for the Knitting People had overheard many of the lessons which the Thimble People gave her, and they were almost jealous. At least they probably would have been jealous if they had not planned to surprise Mary Frances with some delightful lessons in crocheting and knitting. Such good lessons they were that almost before she knew it, Mary Frances had made the loveliest caps and sweaters and bootees for her dolls—just exactly the

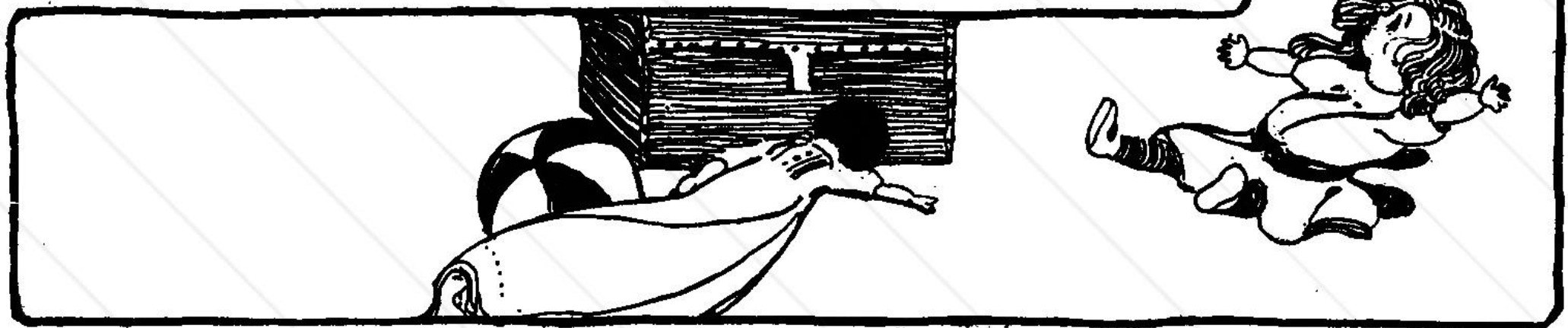

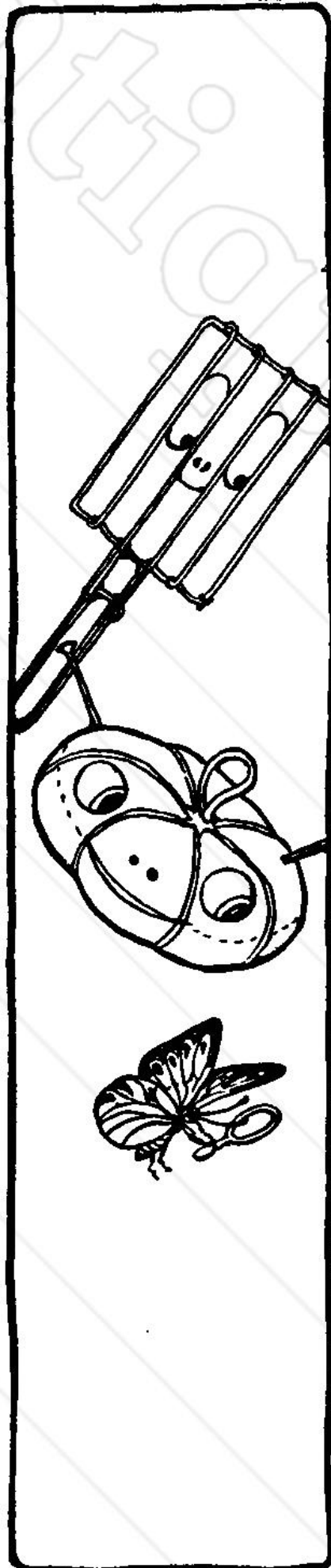

kinds you want for your own dolls. And you can have them if you wish, for Mary Frances says that the Knitting People told her that they are always just as ready to help any other girl who wants their help—if she will follow the lessons exactly as they are given in this book.

She says, too, that after a girl has learned to crochet and knit for dolls, it is “just as easy as a-b-c” to crochet and knit for real people; and that knitting articles for soldier boys and fathers and mothers makes a person feel of very much account.

It is in the hope that you will enjoy these new adventures as much as Mary Frances did, that this book is sent out to the girls of America with the best wishes of

THE AUTHOR.

Merchantville, N. J.

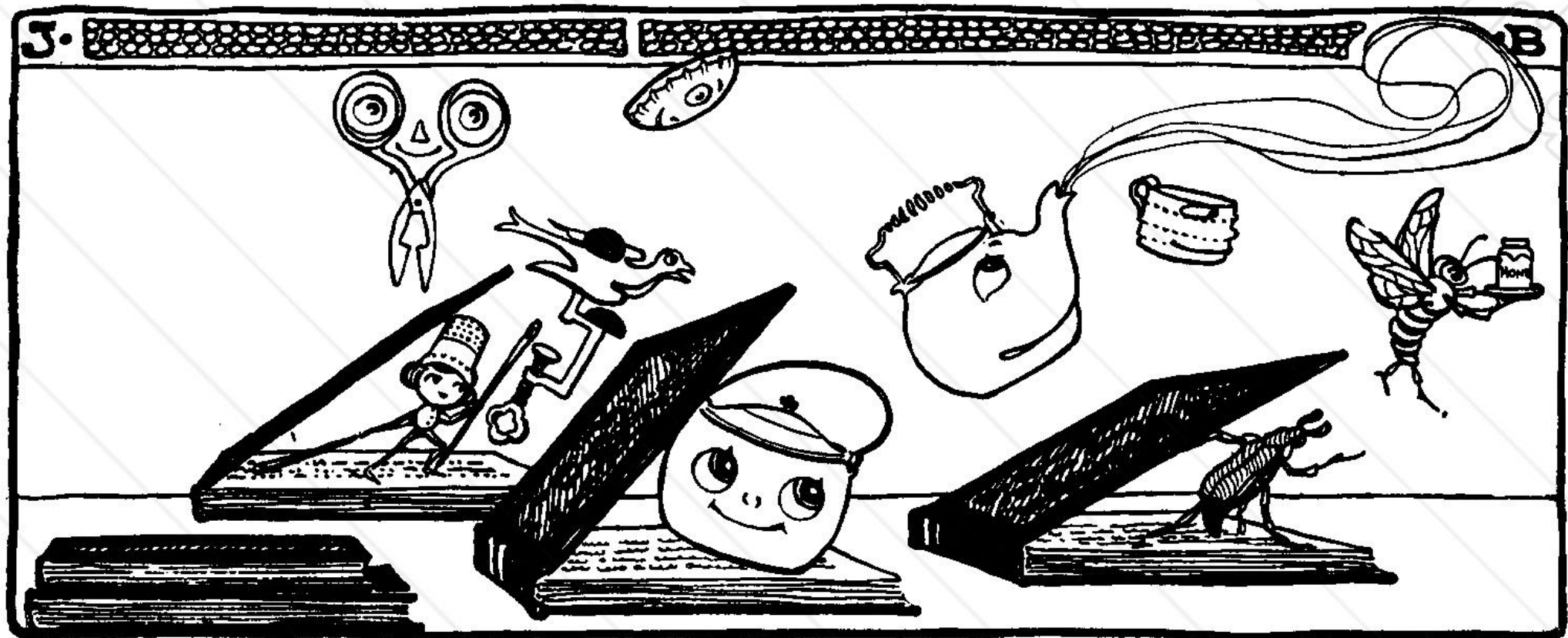

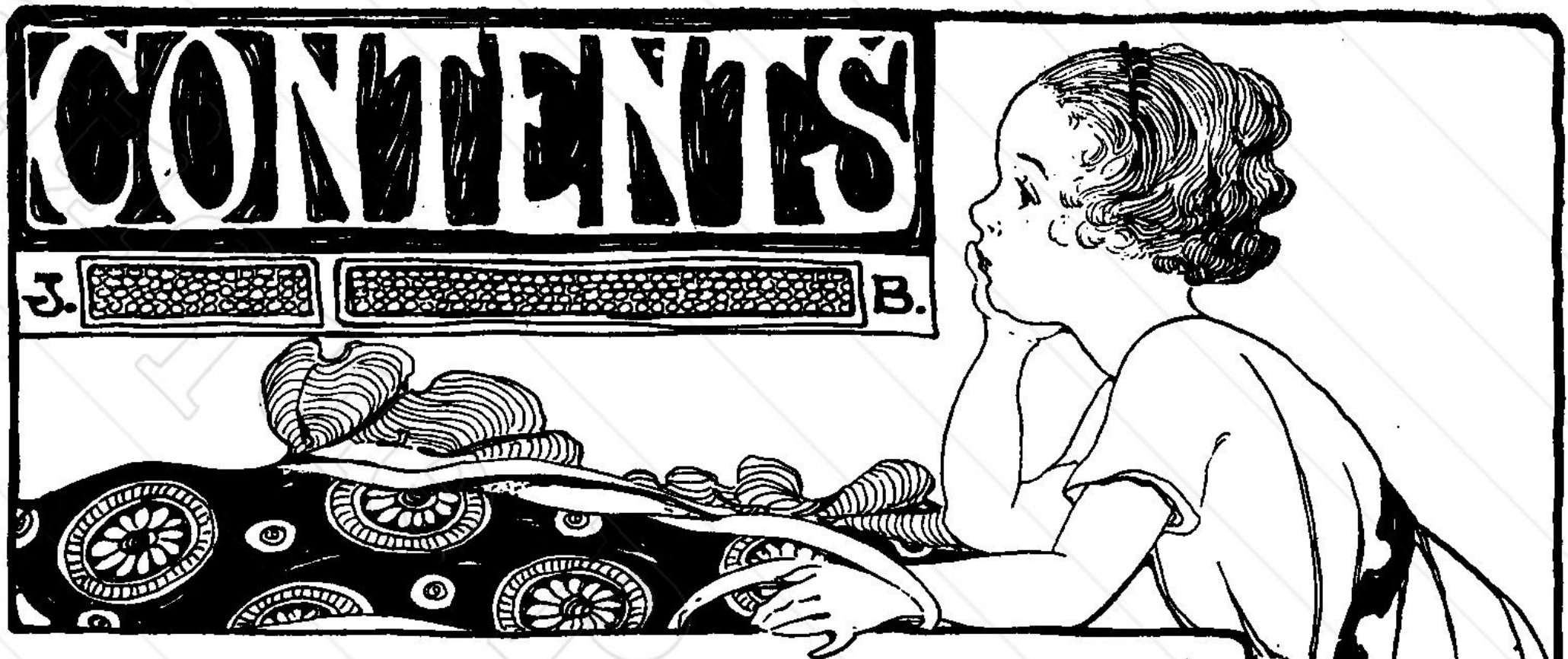

CHAPTER	PAGE
I. KNIT AND KNACK	15
II. AUNT MARIA STEPS IN.	19
III. CROW SHAY TALKS	25
IV. WOOLEY BALL TELLS SOME YARNS .	29
V. SPEAKING OF MOTHS.	35
VI. CROW SHAY'S RELATIVES.	39
VII. A DISAPPOINTMENT	43
VIII. A DOLL'S NECKLACE.	47
IX. A TELEGRAM	55
X. MAKING PLANS	61
XI. A ROSE SCARF	67
XII. MARY MARIE'S SHAWL.	73
XIII. FAIRLY FLEW FLIES IN	79
XIV. A LITTLE PETTICOAT.	83
XV. MARY MARIE'S CAP	93
XVI. MARY MARIE'S TURBAN	99
XVII. MARY MARIE COMES TO LIFE . . .	105
XVIII. THE MAGIC RHYME	113

[v]

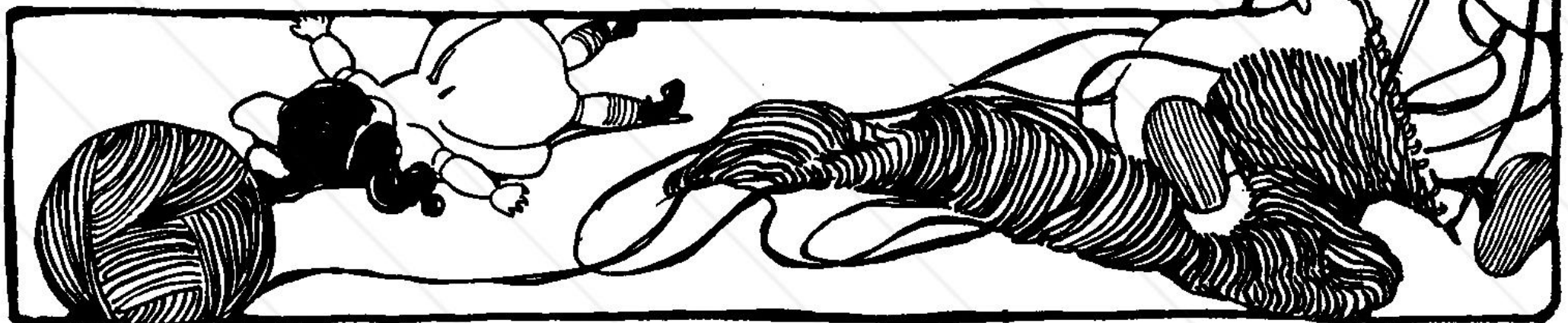

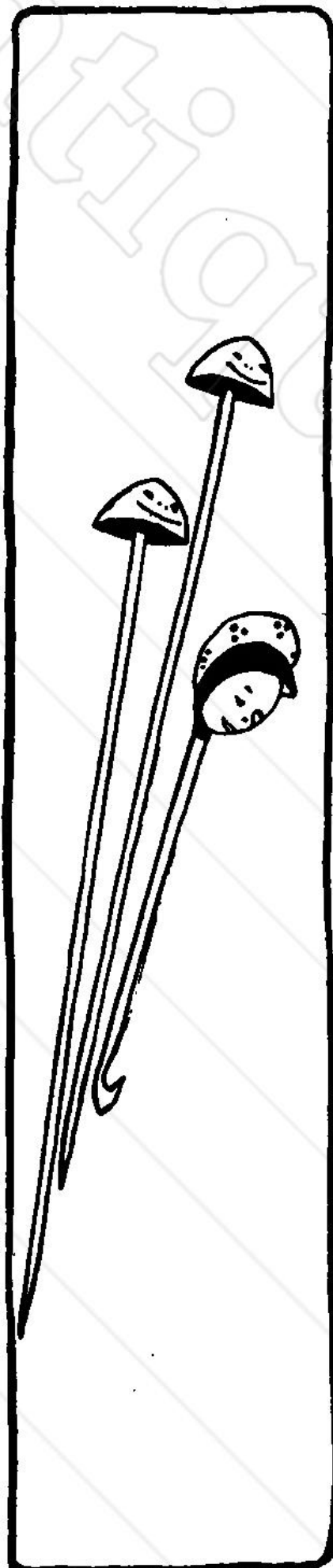

CHAPTER	PAGE
XIX. MARY MARIE'S SCHOOL BAG	117
XX. A LETTER FROM MOTHER	121
XXI. A TEDDY BEAR SUIT	127
XXII. THE FIRST KNITTING LESSON	145
XXIII. CASTING ON STITCHES	149
XXIV. CROW SHAY HELPS KNIT	153
XXV. TO KNIT A STITCH	159
XXVI. MARY FRANCES REALLY KNITS	165
XXVII. DOING IT OVER AGAIN	169
XXVIII. DOLL'S KNITTED HOOD	175
XXIX. WHAT'S A PURL?	179
XXX. DOLL'S SLEEVELESS SWEATER	183
XXXI. GOOD NEWS	191
XXXII. THE BOY AVIATOR	195
XXXIII. MARY MARIE'S SPORTS SWEATER	201
XXXIV. HOME AGAIN	215
XXXV. A GIFT FROM THE QUEEN OF FAIRIES	219
XXXVI. THE MAGIC PAPER	225
XXXVII. THE MAGIC PAPER (<i>Continued</i>)	227
XXXVIII. TWO MORE SWEATERS	262
XXXIX. RED CROSS KNITTING	265

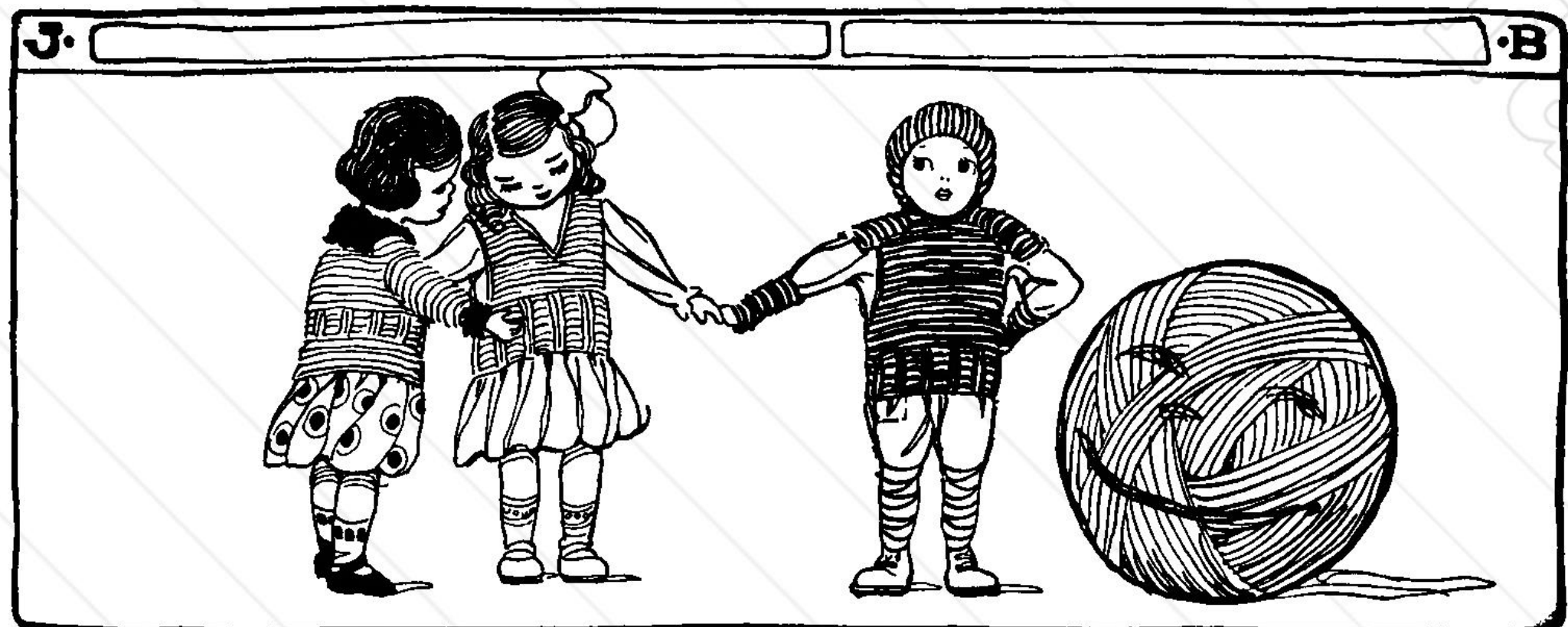

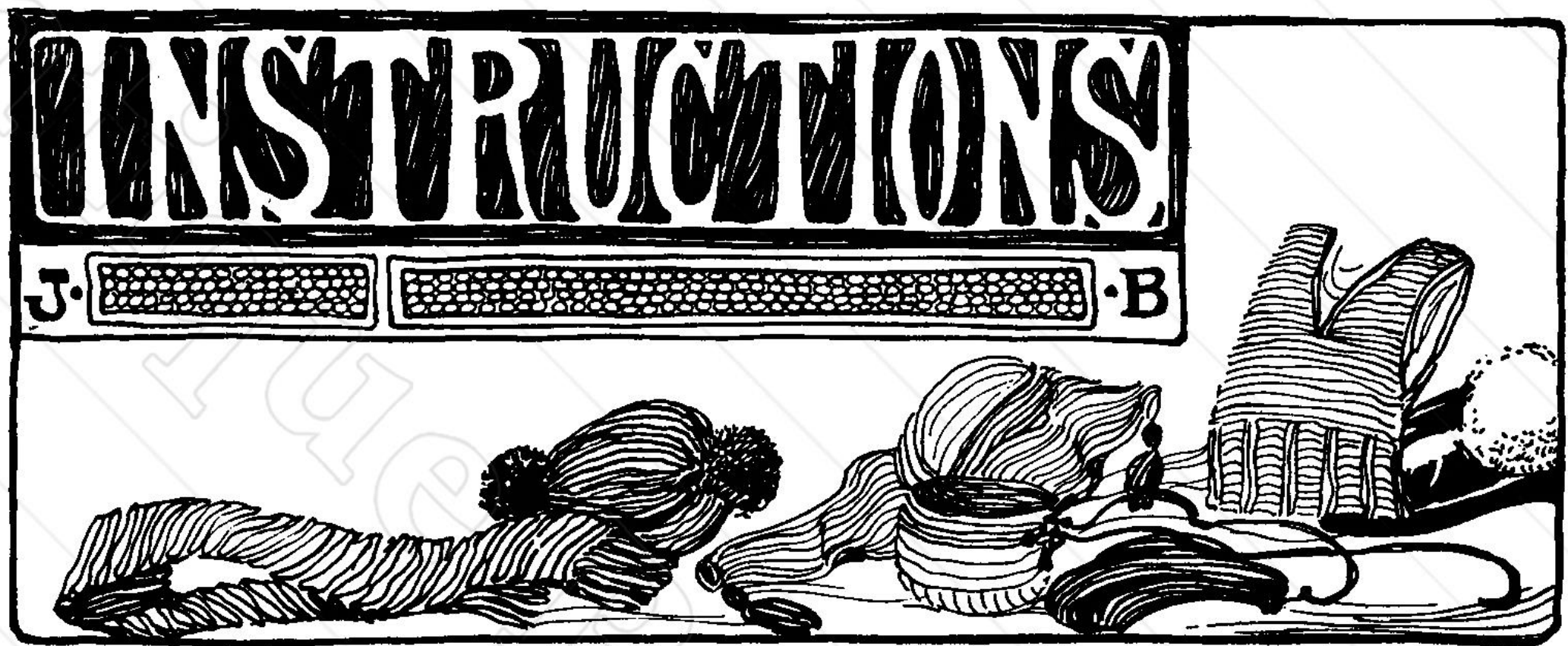

	PAGE
DIFFERENT YARNS.....	31
NAMES OF YARNS.....	32
CROCHET HOOKS AND KNITTING NEEDLES.....	40
SCALE OF SIZES.....	41
TO MAKE CHAIN STITCH.....	48
DOLL'S CROCHETED NECKLACE.....	50
TO MAKE SINGLE CROCHET.....	51
TO MAKE DOUBLE CROCHET.....	52
TO MAKE SLIP STITCH.....	53
DOLL'S CROCHETED SCARF.....	69
TO MAKE FRINGE.....	69
DOLL'S CROCHETED SHAWL.....	75
TO JOIN ENDS OF YARN IN CROCHETING.....	76
DOLL'S CROCHETED WOOL FLOSS SCARF.....	84
DOLL'S CROCHETED PETTICOAT.....	88
HOW TO "INCREASE" IN CROCHETING.....	89
TO MAKE THE SCALLOPS.....	89
TO MAKE THE RUNNER.....	90



[vii]

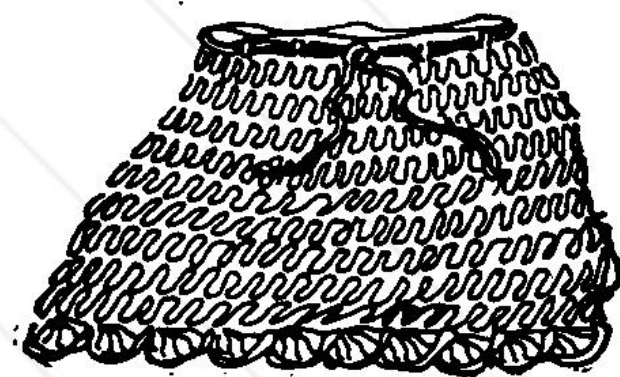

	PAGE
DOLL'S CROCHETED TOQUE OR CAP.....	93
TO MAKE POMPONS.....	95
DOLL'S CROCHETED TURBAN (HAT).....	99
BABY'S BALL.....	107
HAIR PIN BALL.....	107
DOLL'S CROCHETED BEDROOM SLIPPERS.....	108
TO MAKE TASSELS.....	111
DOLL'S CROCHETED BOOK BAG.....	118
HOW TO MAKE AN INFANT YARN DOLL.....	121
HOW TO MAKE A COLORED YARN DOLL.....	123
TEDDY BEAR SUIT, CONSISTING OF—	
CROCHETED SWEATER.....	129
CROCHETED TAM.....	135
HOW TO "DECREASE" IN CROCHETING.....	137
CROCHETED LEGGINGS.....	138
FIRST LESSON IN KNITTING—	
TO MAKE A SLIP KNOT.....	148
TO CAST ON STITCHES WITH THE FINGERS..	150
TO CAST ON STITCHES WITH A CROCHET	
HOOK.....	155
TO KNIT PLAIN.....	162
TO SLIP A STITCH.....	163
HOW TO BIND OFF.....	166

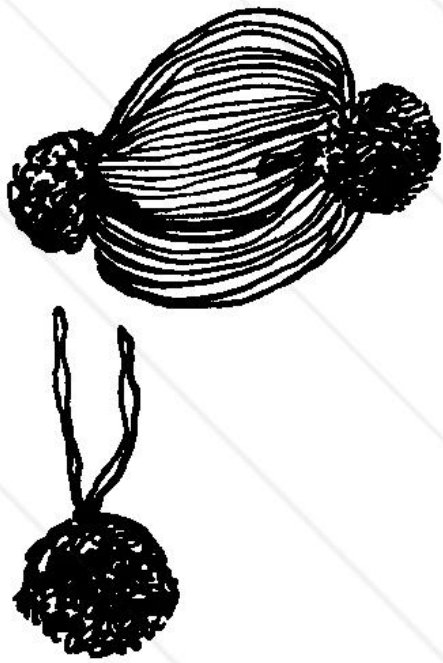

INSTRUCTIONS

ix

	PAGE
DOLL'S KNITTED SHAWL.....	171
DOLL'S KNITTED HOOD.....	176
DOLL'S KNITTED BEAN BAG.....	180
HOW TO PURL.....	180
DOLL'S KNITTED SLEEVELESS SWEATER.....	185
TO SLIP OFF STITCHES NEEDED LATER.....	186
TO INCREASE OR ADD A STITCH IN KNITTING	186
AVIATOR DOLL'S OUTFIT—	
KNITTED HELMET.....	196
KNITTED WRISTLETS.....	196
KNITTED SLEEVELESS SWEATER.....	197
DOLL'S KNITTED SPORTS SWEATER.....	201
TO DECREASE STITCHES IN KNITTING.....	202
LITTLE CROCHETED HAT.....	206
DOLL'S CROCHETED MITTENS.....	211
TREBLE CROCHET.....	228
INFANT DOLL'S CROCHETED OUTFIT—	
INFANT DOLL'S CROCHETED SOCKS.....	228
INFANT DOLL'S CROCHETED CAP.....	229
INFANT DOLL'S CROCHETED SACQUE, No. 1	230
TO ATTACH NEW YARN.....	231



	PAGE
INFANT DOLL'S CROCHETED SACQUE, No. 2	232
AFGHAN STITCH.....	234
INFANT DOLL'S CROCHETED CAPE AND HOOD	236
DOLL'S CROCHETED COACH COVER.....	239
COFFEE BEAN STITCH.....	239
DOLL'S CROCHETED SPORTS HAT.....	240
DOLL'S CROCHETED BREAKFAST CAP.....	241
DOLL'S CROCHETED GARTERS.....	242
DOLL'S CROCHETED SHOPPING BAG.....	242
DOLL'S CROCHETED SPORTS SWEATER.....	243
DOLL'S CROCHETED FLOWER BASKET.....	246
GIRL'S CROCHETED HAND BAG.....	248
CRAZY STITCH.....	248
BABY'S CROCHETED BOOTEES.....	249
STAR STITCH.....	251
BABY'S CROCHETED BALL.....	252
CURLY STITCH.....	252
LADY'S CROCHETED NECKLACE.....	253
HOW TO MAKE BUTTON BALLS.....	253
BEAD STITCH	254
LADY'S CROCHETED PURSE.....	255
HOW TO MAKE PICOT EDGING.....	255



INSTRUCTIONS

xi

	PAGE
DOLL'S KNITTED MUFF.....	257
DOLL'S KNITTED BOA OR STOLE.....	257
DOLL'S KNITTED BREAKFAST SHAWL.....	259
DOLL'S KNITTED SLEEVELESS SILK SWEATER....	259
HOW TO CAST ON STITCHES WITH KNITTING NEEDLES.....	260
THE CONTINENTAL METHOD OF KNITTING.....	262
TO CAST OFF STITCHES.....	262
CHILD'S KNITTED SWEATER.....	262
LADY'S KNITTED SWEATER.....	263
RED CROSS KNITTING.....	265
EQUIPMENT.....	265
GENERAL DIRECTIONS.....	265
MUFFLER.....	265
WASH CLOTH.....	267
SLEEVELESS SWEATER.....	267
KNITTED HELMET, No. 1.....	267
KNITTED HELMET, No. 2.....	268
WRISTLET, No. 1.....	268
WRISTLET, No. 2.....	268
MEDIUM-SIZED SOCK.....	268
BED SOCK.....	270
HOT WATER BOTTLE COVER.....	270

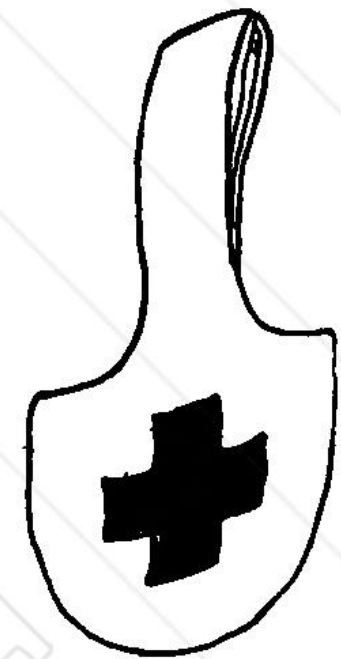

NOTE.—The garments described in this book will fit 12- to 16-inch dolls.

It is impossible to give exact measurements, because few people crochet and knit with exactly the same “tension.”

In making garments for other than 12- to 16-inch doll it would be best to cut a paper pattern to fit the doll, and make the garments fit the pattern, following as far as possible the directions given in this book.

IMPORTANT.—In order to learn to crochet and knit, the beginner should follow the directions, and make the garments, in the order given in the story part of the book.

Do not try to understand the directions before doing the work. Learn one new thing at a time doing exactly as told. Advance step by step.

In these directions woolen yarns are used, but mercerized cotton yarns may be used in their place with good results.



COLORED ILLUSTRATIONS

**LIST OF
COLORED ILLUSTRATIONS**

SEE MY NEW SWEATER	<i>Frontispiece</i>
	OPPOSITE PAGE
OFF TO SCHOOL	40
LET US PLAY BALL	72
GOING SHOPPING	104
BABY BLUE AND BABY PINK	136
OUR FRIENDS TEDDY BEAR AND AIRMAN	168
READY FOR CHURCH	200
FLOWERS FOR MOTHER	230

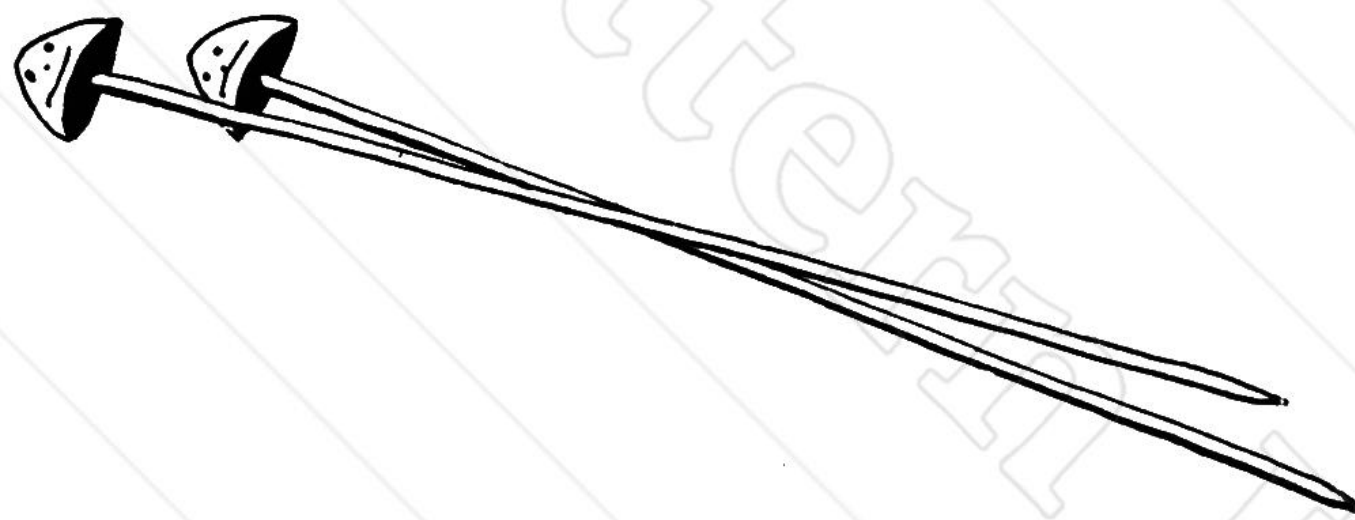

"Did you say Knit?"



E will teach her to knit," declared Mary Frances' grandmother's knitting needles proudly. They spoke together.

When they did not speak together they always repeated what each other said. You see, they were twins. One was named Knit and the other was named Knack.

"And I will teach her to crochet," said the big crochet hook just as proudly.

"Knitting is a much older art than crocheting," said Knit.

"Knitting is a much older art than crocheting," repeated Knack.

"Knit!" exclaimed Crow Shay Hook. "It is not!"

[15]

"We will teach her to knit"

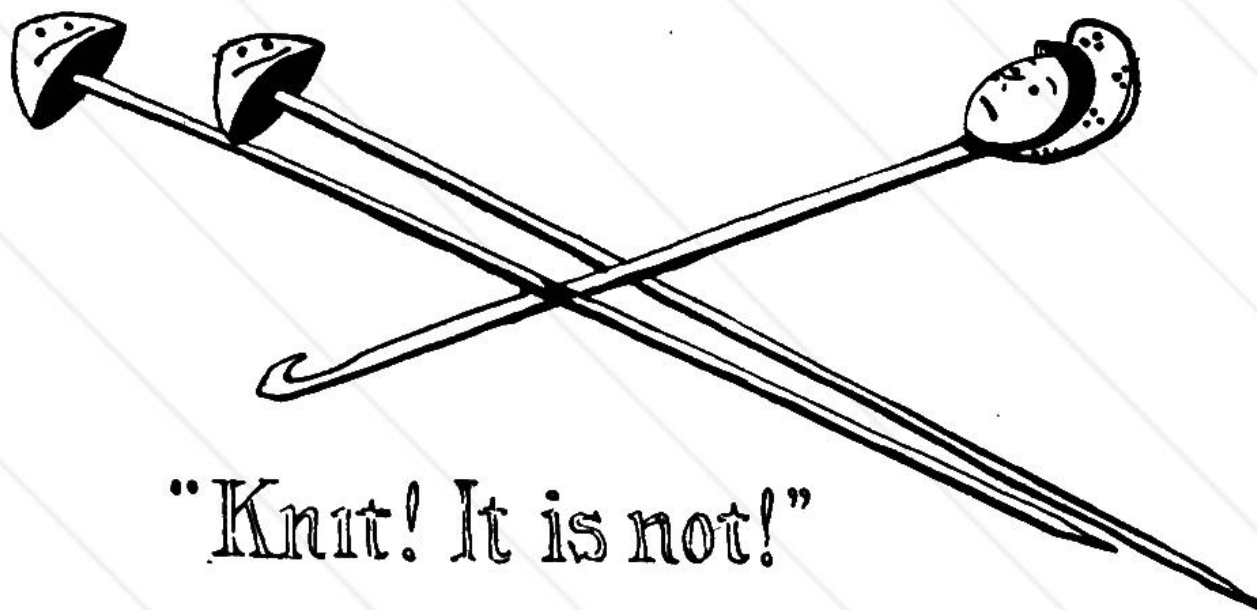

"Knit! It is not!"

"How can you prove that?" asked Knit.

"How can you prove that?" asked Knack.

"Easily!" answered Crow Shay. "Crocheting is making knots. Knots were made by people before they ever thought of weaving. Knitting is a sort of weaving, you know. Knotting is not, you know."

"To tell the honest truth," a new voice spoke, "I do not believe any of you know what you are talking about; but I could tell you a story—" and the big ball of yarn rolled over nearer the group of needles.



"To tell the honest truth"

"Oh, spare us, Wooley Ball!" begged all the needles. "We don't want to hear any more yarns."

"It is easy to see," went on Wooley Ball, pretending not to notice their impoliteness, "that for most people crocheting is more easily learned than knitting. Therefore it seems best that Crow Shay should begin the lessons."

"What's that?" The Yarn Baby suddenly sat up, her hair standing out straight on her head. It always stood up straight and stiff when she was excited. "You know very well, Wooley Ball, that I was chosen to direct these lessons."



"What's that?"

"Please excuse me?" begged Wooley Ball. "I am always so interested in knitting and crocheting that sometimes I forget myself, I fear."

The Yarn Baby's hair slowly settled back into place. She smoothed and patted it down carefully.

"It so happens that I felt that Crow Shay had best commence the lessons," she said.

Crow Shay glanced over at the Knitting Twins.

"Get the hook!" laughed the Knitting Needles. "We shall have lots of fun listening to the crocheting lessons."

"All right," cried Wooley Ball to Crow Shay; "let's get ready, Hookey. I'll chase you into the Red Cross knitting bag!" and away hopped Crow Shay, while the big ball rolled after him. Right down into the bottom of the big bag they landed and Crow Shay cuddled up close to Wooley Ball.

"We shall have a splendid time with Miss Mary Frances, don't you think, Wooley Ball?" asked Crow Shay.

"Indeed we shall," said Wooley Ball warmly. "If we begin to have the fun the Thimble People had, we shall feel very happy."

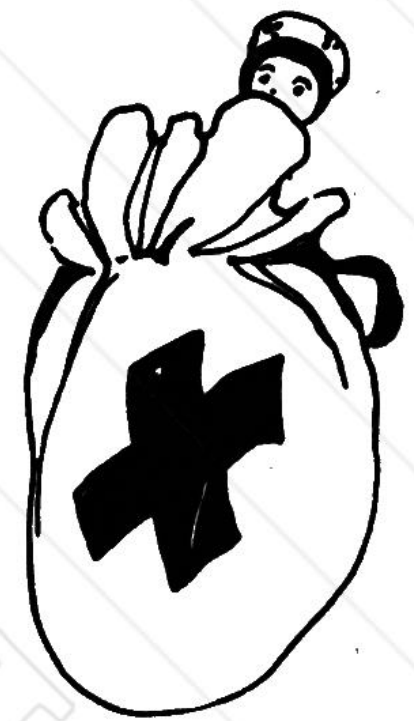

Into the Red
Cross knit-
ting bag.

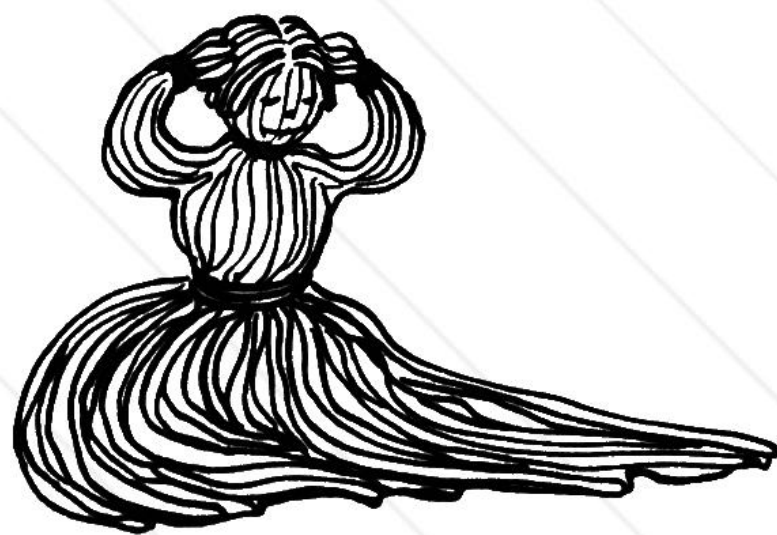

She smoothed it down carefully.



"But don't you remember?"

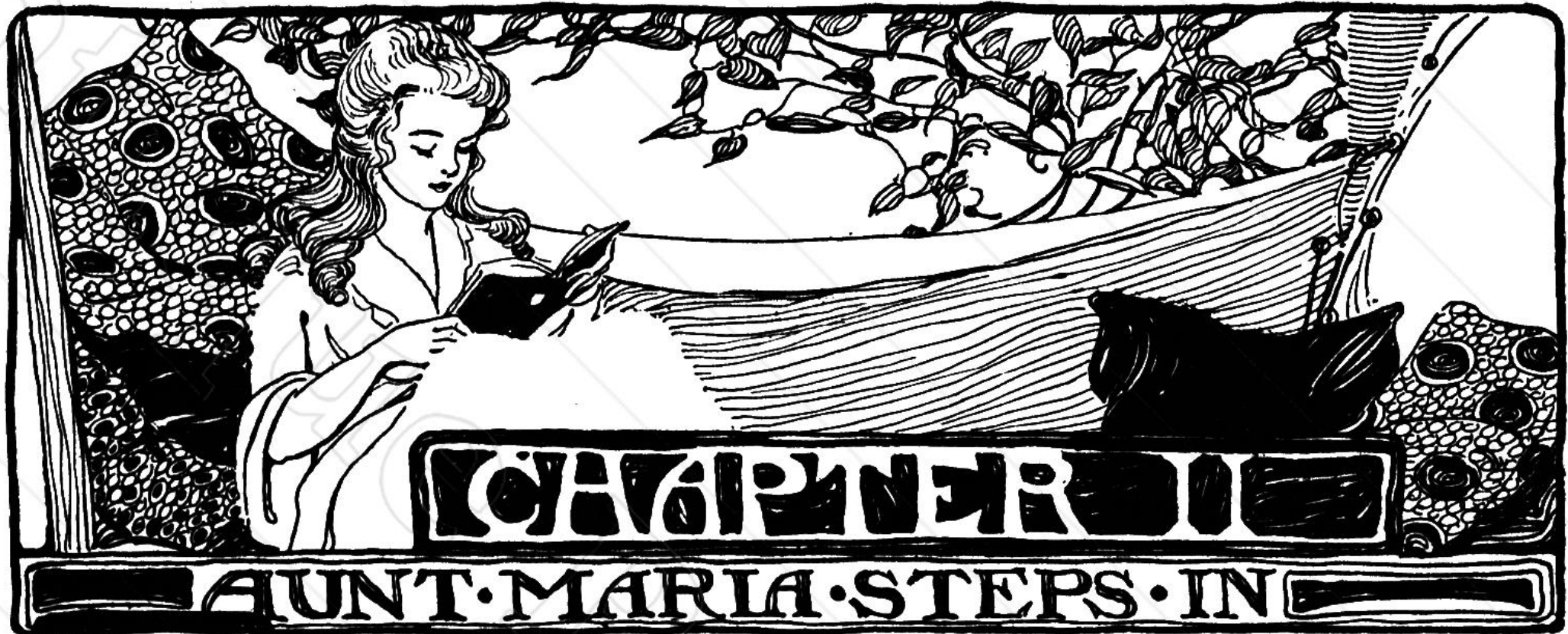

OR a long time Wooley Ball and Crow Shay lay very still in the knitting bag, hoping that Mary Frances would soon come into the room.

At length Crow Shay began to move about restlessly.

“Do be quiet,” whispered Wooley Ball softly. “If you don’t stop jumping about, you’ll punch a hole in the bag!”

“I can’t keep still,” complained Crow Shay; my foot’s asleep! My, how it hurts!”

“How does it feel?” asked Wooley Ball, in sympathy.

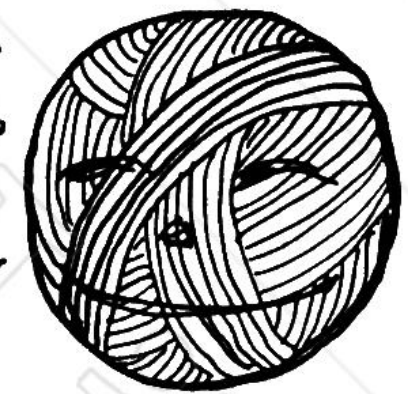

Wooley Ball lay very still.



Hoping Mary Frances would come.

“Just like tiny mosquito bites all over me which scratching won’t help.”

“I guess you mean moth bites!” exclaimed Wooley Ball.

“Will you two keep still?” said the Yarn Baby, tapping upon the knitting bag with her soft little fist. “I think that I hear footsteps.”

“Don’t speak to me now,
Don’t speak to me never;
And I will be quiet
Forever and ever!”



Poking his
head up.

sang Crow Shay, poking his little round head up through the top of the bag.

“Oh, are you going to be bad?” sighed the Yarn Baby. “Get down in there!” She pushed his head down into the bag and tied it shut.

“Now, he’s shut up,” she said, settling down beside the bag, and smoothing her hair, which had begun to stand up.

She was just in time, too, for as she finished putting the last strand in place the door opened, and in stepped—Mary Frances’ Aunt Maria!

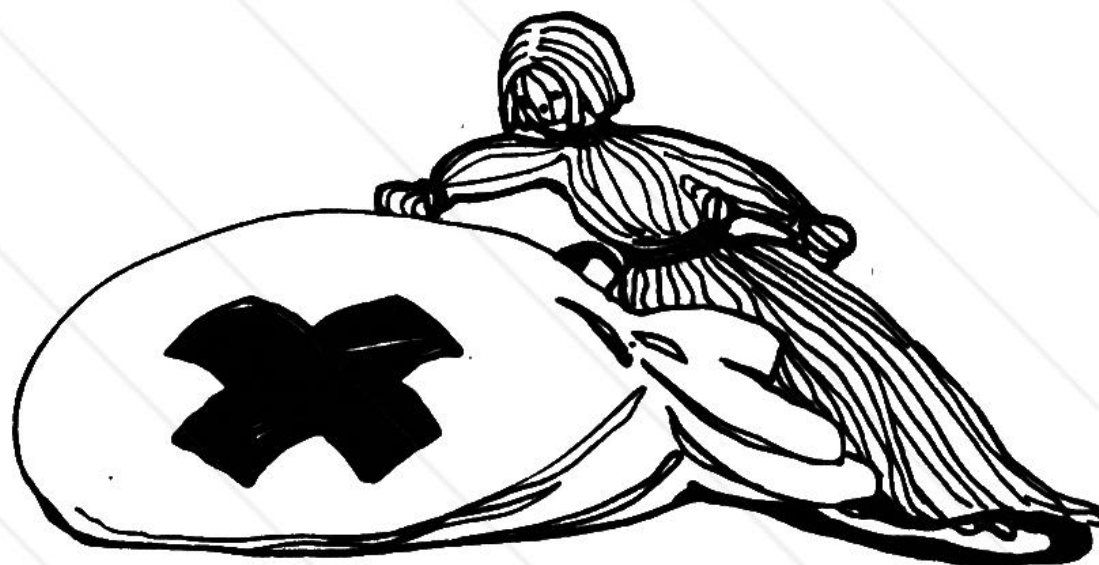

“Will you two keep still?”

“For the land’s sake!” she exclaimed. “For the land’s sake! So that is where Mary Frances left her knitting bag! I’ve hunted high and low for it. I never thought to look on the floor!”

She sat down on Mary Frances’ little rocking-chair and emptied Wooley Ball and Crow Shay on her lap.

“Very well,” she said, “these things will do to start with. I shall begin her lessons to-night.”

Just as she put them back into the bag, she spied the Yarn Baby.

“I’ll put that silly doll in, too,” she said, tumbling the Yarn Baby into the bag and pulling the drawing-strings tight.

Then she carried the bag downstairs and out on the porch, where Mary Frances sat in the porch swing reading a book.

“It is high time, my dear,” she said, “that you learn to crochet and knit. To-night I shall give you your first lesson.

“Oh, won’t that be splendid, Aunt Maria?” cried the little girl. “I do want to learn so much!”

“It seems very strange to me that you do not know



Wooley Ball
and Crow
Shay.



“Won’t that be splendid?”

anything about such work," said her aunt. "Why, I made your father learn how to knit when he was only six years old!"

Mary Frances did not tell her Aunt Maria that her father had told her about those lessons, and how he had hated the work because, every time he made a mistake, his aunt would whack his chubby, clumsy little fingers with a ruler.

You see, Aunt Maria was Mary Frances' great-aunt, and was the aunt of her father also. Mary Frances' grandmother, the mother of Mary Frances' father, died when he was a little boy and his Aunt Maria had "brought him up."

"Mother would like to teach me," said Mary Frances, "but——"

"Your mother was not brought up right," her aunt snapped. "What does she know about crocheting? She doesn't know star stitch from coffee-bean stitch, and as for knitting—I don't suppose she knows plain knitting from purling! Very queer! A very queer way to bring up a child!"

"But, Aunt Maria, don't you remember? Mother fell and hurt her arm when she was little and couldn't



Aunt
Maria.



"But don't you remember?"

use it for such work for years," said Mary Frances. "Even now it hurts her arm to try to crochet. That is what I commenced to tell you."

"Oh, yes," said Aunt Maria, "I remember now. But your arm doesn't hurt, and you must learn to crochet and knit, my dear niece. You are so much like me anyway that you must learn to crochet and knit well. Then you may grow up to be almost exactly like me! Now, I must go set my bread. Nothing ever interferes with my program except sickness or death. You must be like me in that, too." And the old lady went down the path.

At the gate she turned. "Remember," she called "I'll be ready at seven o'clock."



Mary
Frances



"Even now it hurts her"

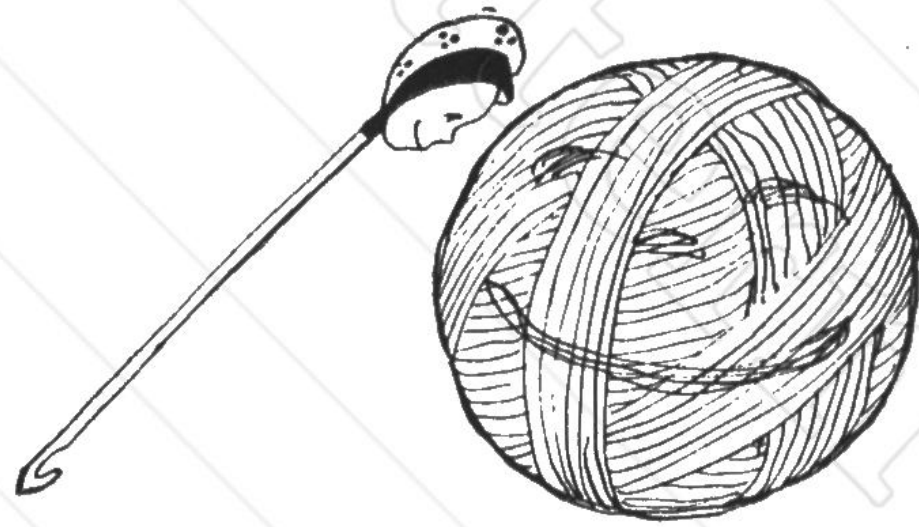

"Oh, he loves to crow—"

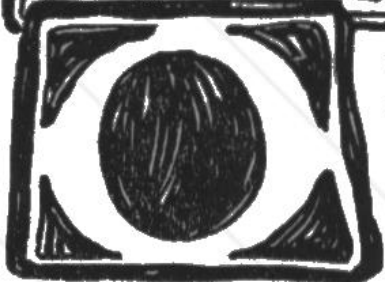

H, dear," sighed Mary Frances. "Oh, dear, how I wish there were crocheting and knitting people like the Kitchen People and the Thimble People—only that would be too good to be true."

"Not at all,
Not at all;
Untie the bag
And see us all,"

came a voice from the knitting bag which was beside Mary Frances in the swing just where Aunt Maria had laid it. She picked it up and untied the drawing-strings and up popped Crow Shay.



"Oh,
dear!"

[25]



Up popped Crow Shay.

The bright sunlight made him blink as he looked around.

“Good day, good day,
To you we say—
Yarn Baby, Wooley Ball
And I, Crow Shay,”

sang the little fellow, as Mary Frances lifted them out.

“Oh, can you all talk?” she asked in delight.

“Can they, Crow Shay?”

““Can they crochet?”” repeated Crow Shay,
““Can they crochet?” Why, I don’t think they can.
They can only help. Crow Shay Hooks are the only
ones who really can crochet!”

“Oh, I see,” said Mary Frances, even though she did not understand exactly what he meant.

By this time the Yarn Baby’s hair was standing on end. She looked so wild that Mary Frances pretended to be frightened and began to move away.

“Do not be alarmed, Miss Mary Frances,” said the Yarn Baby, trying to smooth down her hair. “My hair always stands out that way when I get excited. I was afraid some one might overhear Crow



Sang
the little
fellow.



“Do not be alarmed”

Shay talking, and then all our lovely plans would be spoiled. Crow Shay always talks too much, anyhow. You might think that he was appointed to take charge of the lessons instead of me!"

"Oh," said Mary Frances, "I know what you wish to do! You want to give me secret lessons in crocheting and knitting just as the Kitchen People gave me lessons in cooking, and the Thimble People gave me lessons in sewing! I'll put you all back in the bag and carry you upstairs this minute, and I do hope that you will begin the lessons right away!"



"Crow Shay
always talks
too much"



"I know what you wish to do"

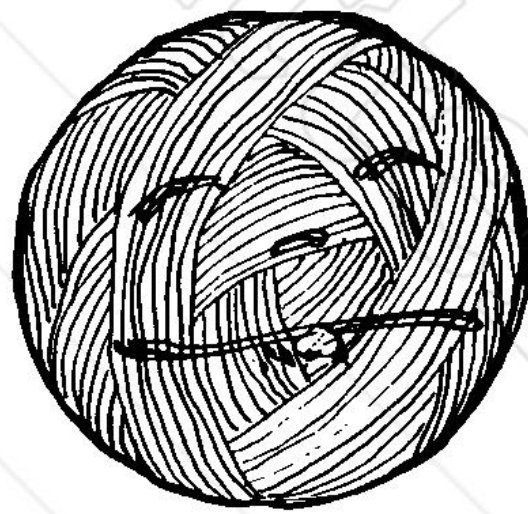

"Hush!" warned Wooley Ball..



MARY FRANCES opened the bag on the sewing table.

"Is this the whole family?" she asked as she lifted the Yarn Baby, Wooley Ball and Crow Shay out.

"Oh, no, indeed!
Oh, no indeed!
Wait till the rest of us
You've see'd,"

spoke up Crow Shay.

Up flew the Yarn Baby's hair.

"'See'd,' indeed! 'See'd,' indeed! Do be more

[29]

Spoke
up Crow
Shay.



"'See'd,' indeed!"

polite, Crow Shay!" she exclaimed. "Use correct grammar and give some one else a chance to speak!"

Then she explained to Mary Frances about the large family of Crocheting and Knitting People who were so anxious to help her.

"Oh, I can't wait to begin!" cried the delighted little girl. "What do I do first?"

"First you will a slip knot make;
Then in your right hand me you'll take—"

began Crow Shay.

"Now, now," exclaimed the Yarn Baby. "There you go again!"

"Oh, he loves to crow—" said Wooley Ball, laughing.

"You mean that I love to crochet, Wooley Ball!" Crow Shay turned toward Wooley Ball.

"Well, I think that Wooley Ball means that you love to crochet so much that when you get a chance, you love to crow about it!" said the Yarn Baby. "You do not wait to give anyone else a chance to talk. Now, the very first person to explain lessons in crocheting and knitting is Wocley Ball."

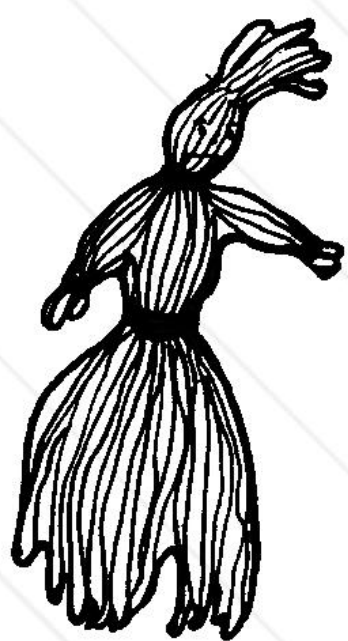

"Do be more polite!"

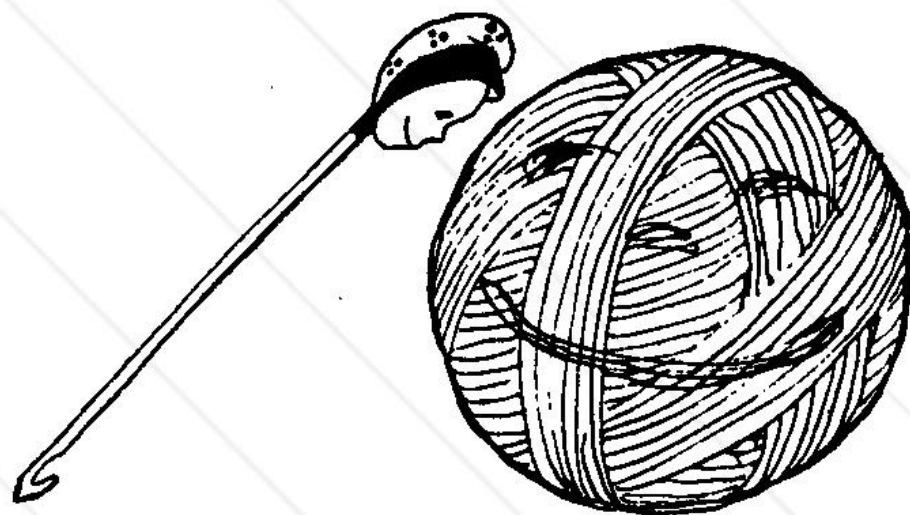

"Oh, he loves to crow—"

“Because she can tell so many yarns!” giggled Crow Shay.

Wooley Ball looked up at Mary Frances with a broad smile.

“Do not mind him,” she said. “If you are quite ready, we will have a little talk about—

DIFFERENT YARNS

There are many different weights and sizes of woolen yarns. We shall need to know about only a few of these.

All yarns are made of twisted strands of thread. The weight depends upon the number and size of the strands that are twisted together.

If two strands are twisted together, the yarn is two-fold.
If three strands are twisted together, the yarn is three-fold.



Giggled
Crow Shay.

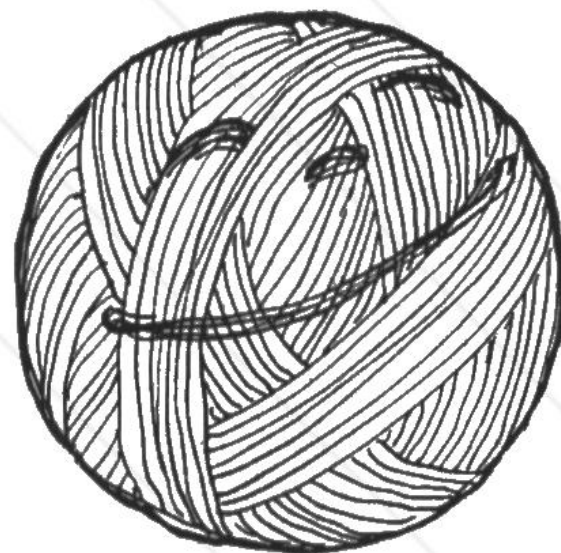
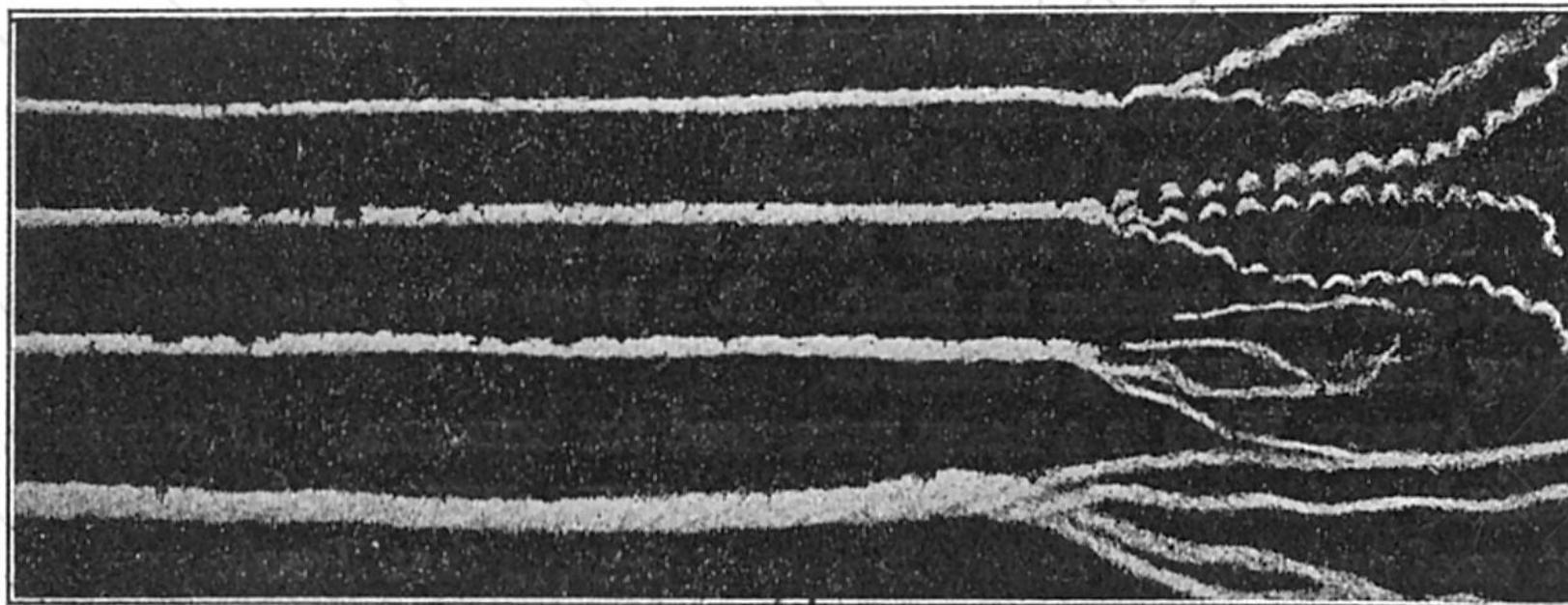

Wooley Ball looked up.

If four strands are twisted together, the yarn is four-fold.
If you are uncertain of the "fold" of the yarn you have,
untwist a little piece and count the strands.

NAMES OF YARNS

Germantown Zephyr or Germantown Wool. A soft woolly yarn very much used where warmth is needed.

Germantown wool comes in four-fold and eight-fold weights. Four-fold is the weight generally used. The eight-fold is too thick and heavy for most purposes.

Knitting Worsted is somewhat like Germantown wool in weight, but is rather harsh to the touch, because the threads are made of long twisted fibers of wool. Garments made of knitting worsted will stand hard wear and usage.

Saxony Wool. A soft yarn made of light-weight strands. Comes in two-fold, three-fold, and four-fold weights.

The four-fold and two-fold are the weights most used. Saxony wool is much used for making garments for babies.

Woolen Knitting Floss. A light-weight, loosely-twisted yarn. Comes in single and double threads.

Teazle Yarn, or Teazle Wool, resembles knitting floss, but is rougher and harsher in finish. It is more often used for trimming than for making garments.

Angora Wool is a hairy yarn used for trimming. It is made entirely of the soft silky hair of the Angora goat, or of a mixture of wool and Angora hair. It is so expensive that Teazle yarn is



Hank of
yarn.



Wool in balls.

WOOLEY BALL TELLS SOME YARNS

33

much used in its stead. After the trimming is made, the Teazle yarn is usually brushed until it is quite furry and fuzzy.

There are many different makers of yarns. Each firm manufactures a variety of yarns under various fancy names. All manufacturers, however, make Germantown Wool, Knitting Worsteds, Saxony Wools, Woolen Flosses, and Teazle Wool.



Needles.



Mary Frances and the wools.



She only smiled.



HERE!" exclaimed Crow Shay as Wooley Ball finished. "There! Hasn't Wooley Ball long yarns to spin?"

Mary Frances laughed. "You little chatterbox," she said, "I really believe that you are jealous!"

"I certainly do love to talk," said Crow Shay; "but I admit I can't tell about yarns the way Wooley Ball can."

Here the Yarn Baby interrupted.

"If you will bring your chest of yarns, little Miss," she said, "we will soon see if you have all those different kinds of yarns."

Mary Frances went to the closet, and brought the chest to the sewing table.

[35]



"There!"



"Bring your chest of yarns"

As she pulled out the bright-colored yarns, some small white balls fell on the table.

"Oh, goody!" exclaimed Wooley Ball. "I see that you are not going to let the moths eat up your treasures. Moths hate camphor and moth balls. I just love them."

"Oh, I know about moths," said Mary Frances. "I learned a sad lesson about them. Once my aunt knit my doll a little——"

"Did you say Knit?" came a little voice.

"Did you say Knit?" came another little voice.

"Who was that?" asked Mary Frances.

"Oh, that's only Knit and Knack, the Knitting Twins," answered Crow Shay.

He turned toward the table where they lay.

"You two go to sleep again!" he said. "It's not your turn yet."

By this time the Yarn Baby looked like a porcupine. Her hair stood out so straight and stiff that Mary Frances was almost afraid to speak.

"He will keep on until he will have to be punished," whispered Wooley Ball.

"Yes," said the Yarn Baby, "if he doesn't stop crowing so much I will not let him crochet."

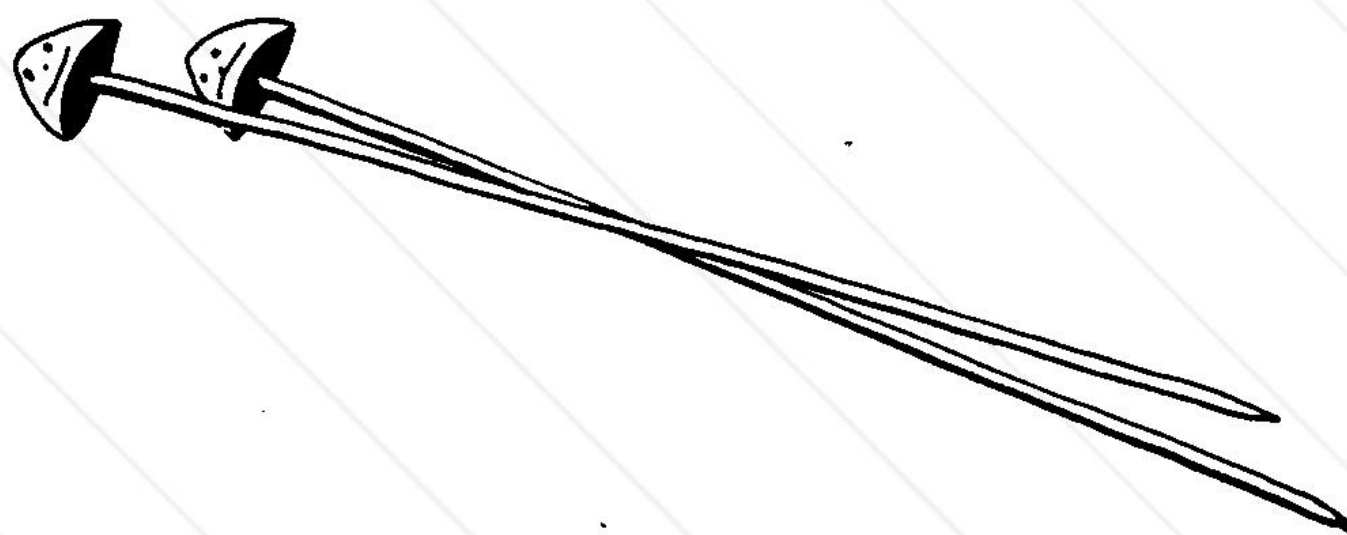

"Did you say Knit?"

Small
white balls.

That seemed to scare Crow Shay terribly, and he did not utter another sound, but listened with all his ears.

"You were speaking of moths," Wooley Ball reminded Mary Frances.

"Oh, yes—about the little coat which my aunt made for Angie, my doll. I used it all winter and in the summer I folded it and put it away in a little box. When the weather was cold again, and Angie needed it, I took it out of the box and what do you think happened?"

"I know!" declared Wooley Ball. "I know what happened. The little coat fell to pieces when you picked it up. The moths had bitten it all over."

"Yes, that's exactly what happened," said Mary Frances. "It taught me never to put anything made of wool away without camphor or moth balls."

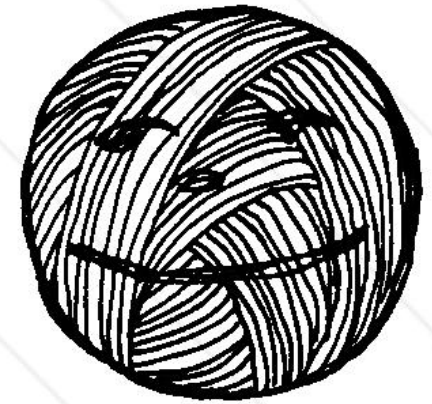

"Speaking
of moths"



"The moths had bitten it all over"

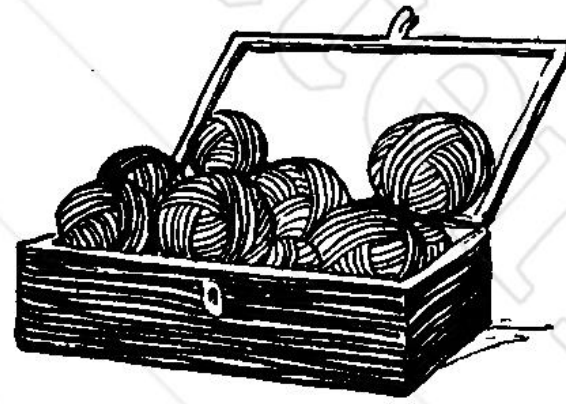

Neatly wound balls.



WOLEY BALL and the Yarn Baby looked over the yarns that Mary Frances had put on the sewing table.

"These are just right," said the Yarn Baby. "You have every kind of wool here that we shall need. Will you see that all the yarns are wound into very, very loose balls before your next lesson?"

"Yes," promised Mary Frances, "I will wind them over my hand the way Aunt Maria does, so that the balls feel quite 'spongey.' I wish that all yarns came from the factories wound in balls, though!"

"You are not the first person to wish that," said the Yarn Baby. "Hanks and skeins are much harder for a child to manage than balls. Now, if

Yes,
I will"



[39]



"These are just right"

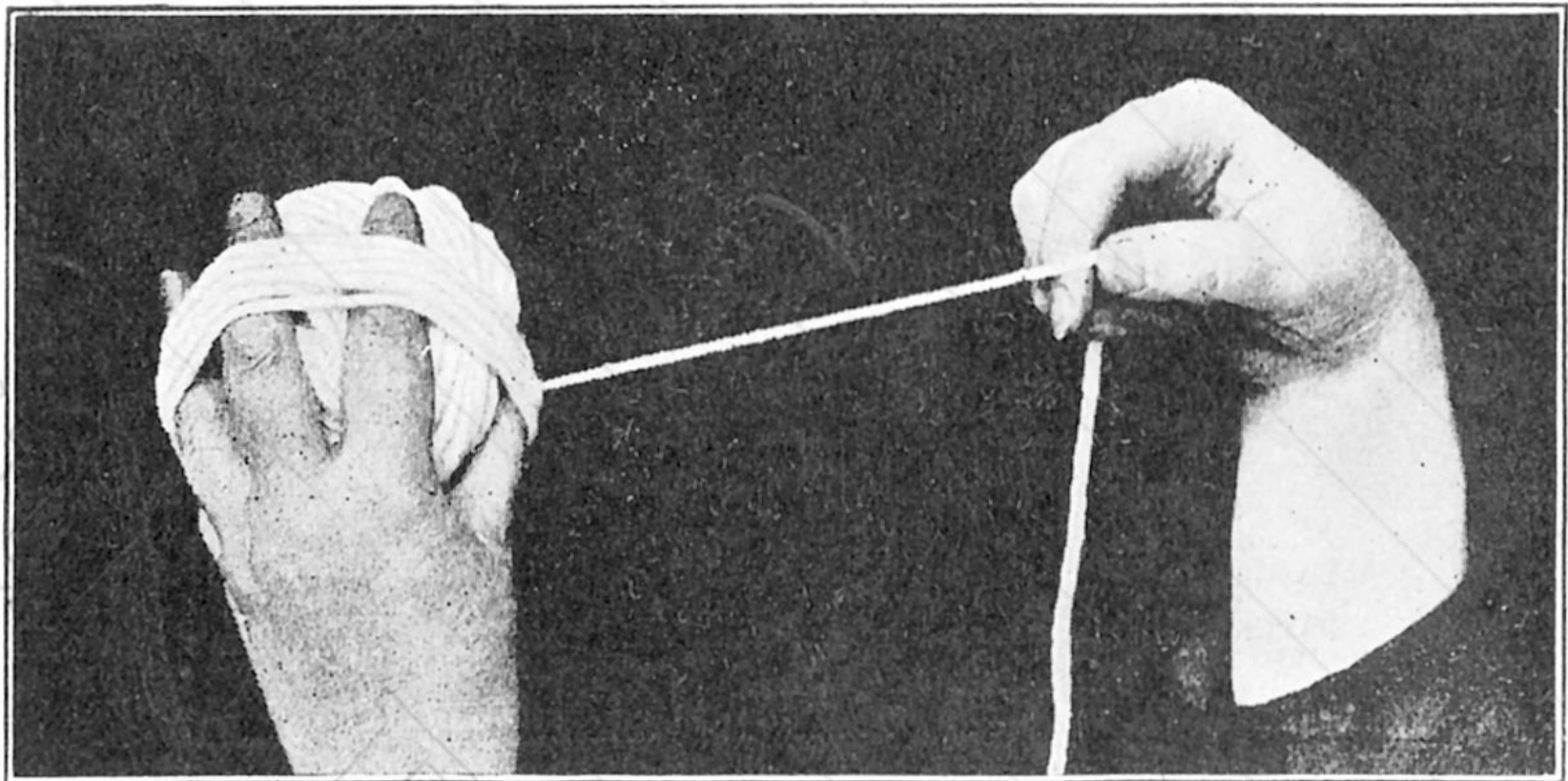

WIND YARNS OVER THE HAND

you please, we will talk a few minutes about crochet hooks."

Crow Shay rolled his eyes toward the Yarn Baby, but did not say a word.

"Come, Crow Shay," said the Yarn Baby; "you may tell us about all your little and big relatives."

Then Crow Shay began to tell about—



Crow Shay began to tell.

CROCHET HOOKS AND KNITTING NEEDLES

Crochet hooks and knitting needles are made of bone, or celluloid (amber), or rubber, or wood. These are usually made in sizes from 0 to 15, size 0 being the smallest.



"Come, Crow Shay"



OFF TO SCHOOL

FOR DIRECTIONS FOR MAKING KNITTED ARTICLES SHOWN IN THIS ILLUSTRATION SEE
CROCHETED SCARF—69 CROCHETED GARTERS—242 HAIR PIN BALL—107
CROCHETED TURBAN (HAT)—99 CROCHETED BOOK BAG—118

Antique Pattern Library

CROW SHAY'S RELATIVES

Crochet hooks and knitting needles are also made of steel. Steel crochet hooks usually come in sizes from 0 to 14.* Size 0 is quite large. Size 14 is very small. Steel knitting needles are usually numbered from 8 to 20. Size 8 is large. Size 20 very fine.

Steel hooks and needles are generally used for making articles of cotton thread, and needles made of bone, celluloid, rubber or wood are generally used for wool work.

"I will give you a gauge card to measure the sizes of crochet hooks and knitting needles," finished Crow Shay.

"Oh, thank you," said Mary Frances, helping Crow Shay take a card out of the knitting bag. "Now I shall feel very much better acquainted with your whole family."

"Take good care of the picture," said Crow Shay. "You may often want to look at it."†

*There is unfortunately no standard of measure for crochet hooks and knitting needles. Various manufacturers number them differently. This scale is used here for convenience only.

† To find size of crochet needles, lay the hooks flat against the circles. To find the size of knitting needles, lay the needles (not the points) against the circles.

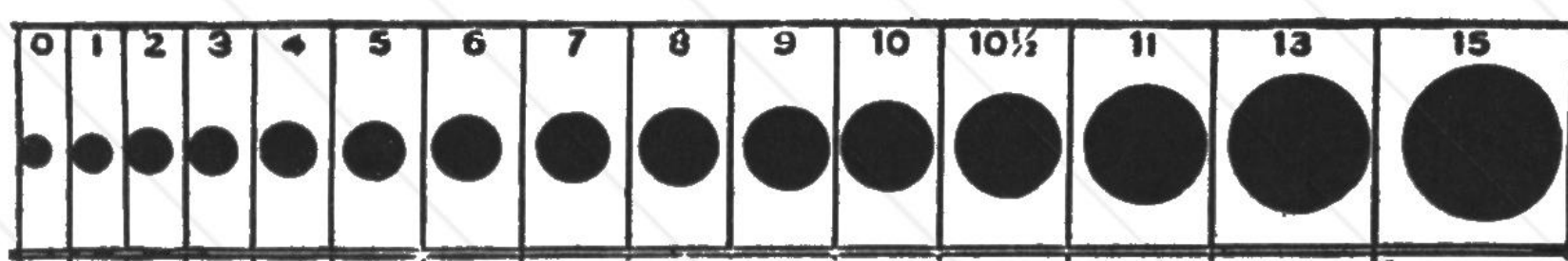

THIS SCALE FOR STEEL KNITTING NEEDLES ONLY



Sizes for knitting and crochet needles.



"Dear little girl."

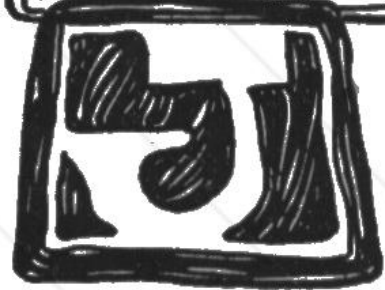
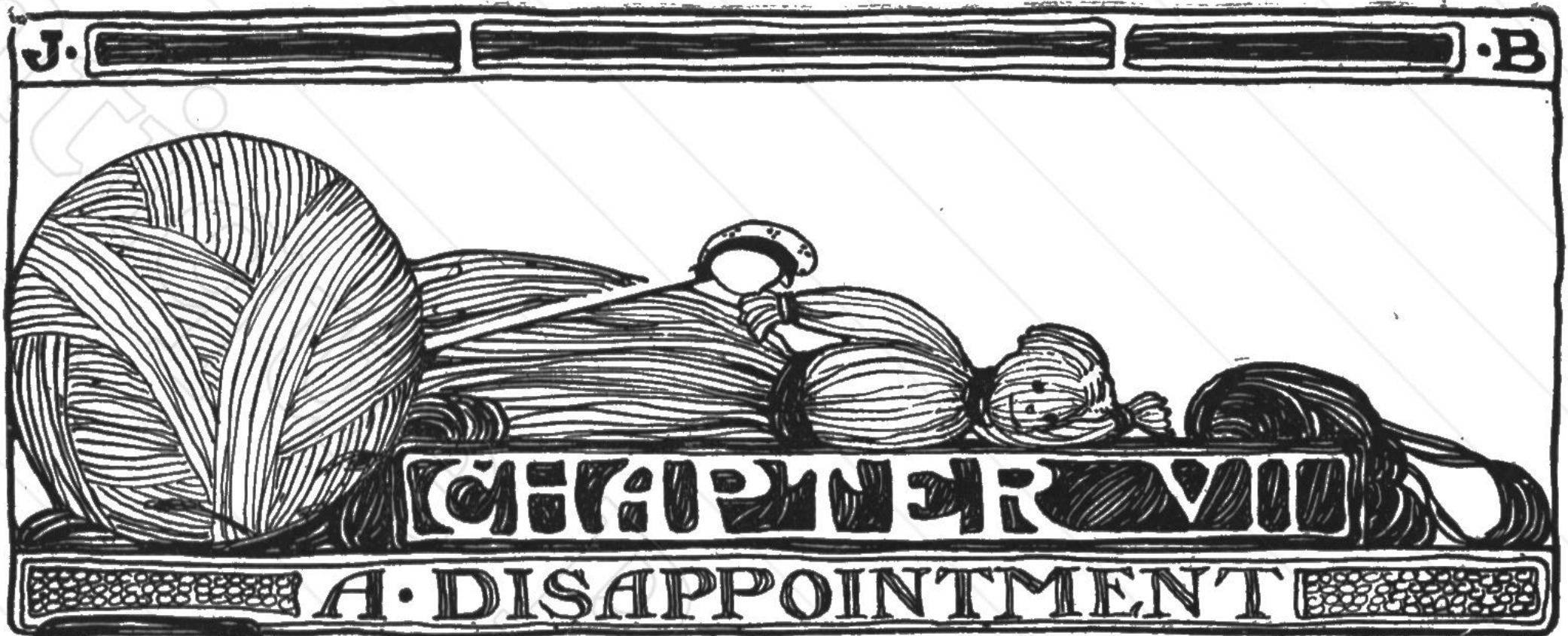

JUST then the gong sounded for dinner.

"What!" exclaimed the little girl. "Is it six o'clock already? Why, I had no idea how time had flown!"

"You must have enjoyed hearing me talk," said Crow Shay. Then, noticing the Yarn Baby's hair, he corrected himself.

"I mean, you must have enjoyed hearing *us* talk," he said.

Then there came footsteps on the stairs.

"Mary Frances, didn't you hear the gong? Mother sent me to look for you," called the little girl's brother Billy. "Where are you, anyway?" he asked as he bounded up the steps.



He correct-
ed himself

[43]



"What! Dinner time already!"

“Mercy!” exclaimed Crow Shay under his breath, as his face melted away.

Wooley Ball rolled over on her face.

The Yarn Baby fell over on her side and looked as dumb as a dumb-bell.

“I’m coming,” called Mary Frances. “I’ll be right down.”

“Oh, do not let anyone know about us,” muttered the Yarn Baby. “If you do, we’ll be deader than sixty coffin nails.”

“I’ll never tell about any of you, dear Yarn Baby,” whispered Mary Frances, hurrying away.

She had scarcely finished her dinner before her aunt came in.

“Seven o’clock,” said the old lady, after greeting the family; “seven o’clock is the time I said we would start our lesson, Mary Frances. Are you nearly ready?”

Poor Mary Frances! She felt like crying when she thought of how Crow Shay, and Wooley Ball and the Yarn Baby had been planning to give her lessons.

“Are you nearly ready?” repeated Aunt Maria.

“Why, yes, Aunt Maria. I will be ready as soon



Poor Mary Frances!

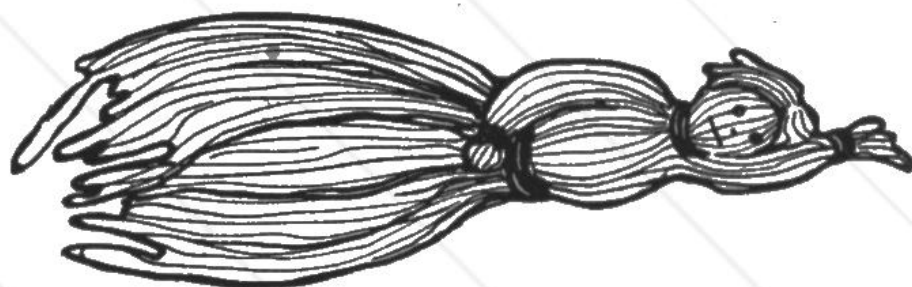

“Deader than sixty coffin nails.”

as I get my knitting bag. I carried it upstairs," she answered.

"I'll wait for you right here at the foot of the stairs," said her aunt. "Then we will go over to my house where no one will interrupt us."

"Oh, dear," thought Mary Frances. "I don't want to go! I guess I shall have to, though. It would disappoint Aunt Maria so dreadfully if I did not."

Mary Frances paused at the door of the room, thinking that she might hear her new friends talking, but there wasn't a sound.

"Let me see—what shall I take?" she thought. "I don't dare take the Yarn Baby. Aunt Maria would think it foolish. I do not want to take Wooley Ball for fear Aunt Maria will use her. I can take Crow Shay, though. He might enjoy the lesson!"

She selected some Germantown zephyr and put it into her knitting bag; then she carefully laid Crow Shay in.

"You will help me a lot," she said as she drew up the strings.

Her aunt was waiting for her. She ran to kiss her mother good-bye, then hurried off with the old lady.



"You will help a lot"



She drew up the strings



"Oh, did she get off?"



LET me see what you have in your bag, child," said Aunt Maria, as soon as they were seated in the big old-fashioned parlor of the old lady's house.

Mary Frances opened the bag. To her surprise Crow Shay winked an eye at her, but his face melted away before Aunt Maria saw it.

She caught up the crochet hook, however, and examined it.

"A very good crochet hook," she said. "Just right to learn with. About a number 5, I judge," looking at it carefully.

She laid it down on the table, and took up Mary Frances' ball of yarn, and showed her how.

[47]



Winked
an eye
at her.



Took up the ball of yarn.

TO MAKE CHAIN STITCH

Material: Germantown wool.

Bone crochet needle No. 5.

CUT* 1

Hold crochet hook and yarn in positions shown in this picture.

CUT 2

Pointing the hook away from you, turn it completely around, bringing a loop on the needle.

CUT 3

With thumb and second finger of left hand take hold of the crossed threads. Now point the hook under the yarn, and catch it on the hook. This is called "wrapping" the yarn.

CUT 4

Pull a loop through the loop which was on the needle.

CUT 5

Pull the loop closer up on the hook, and

CUT 6

Get ready to take another stitch.

CUT 7

Wrap, and draw another loop through the loop on the needle.

CUT 8

Keep on drawing loops through the stitches in this way until you have made quite a long row of chain stitches.

*Cut means picture.



Chain
Stitch

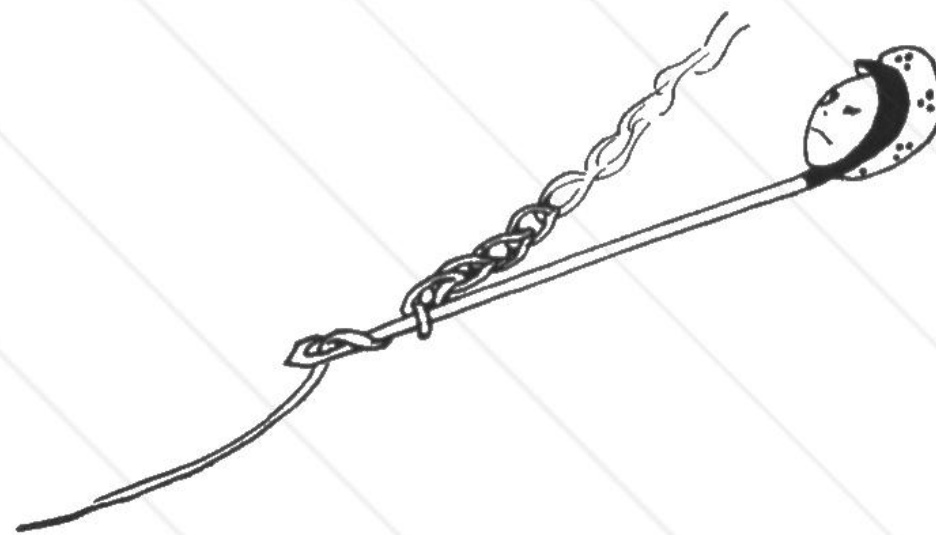

Draw loop through

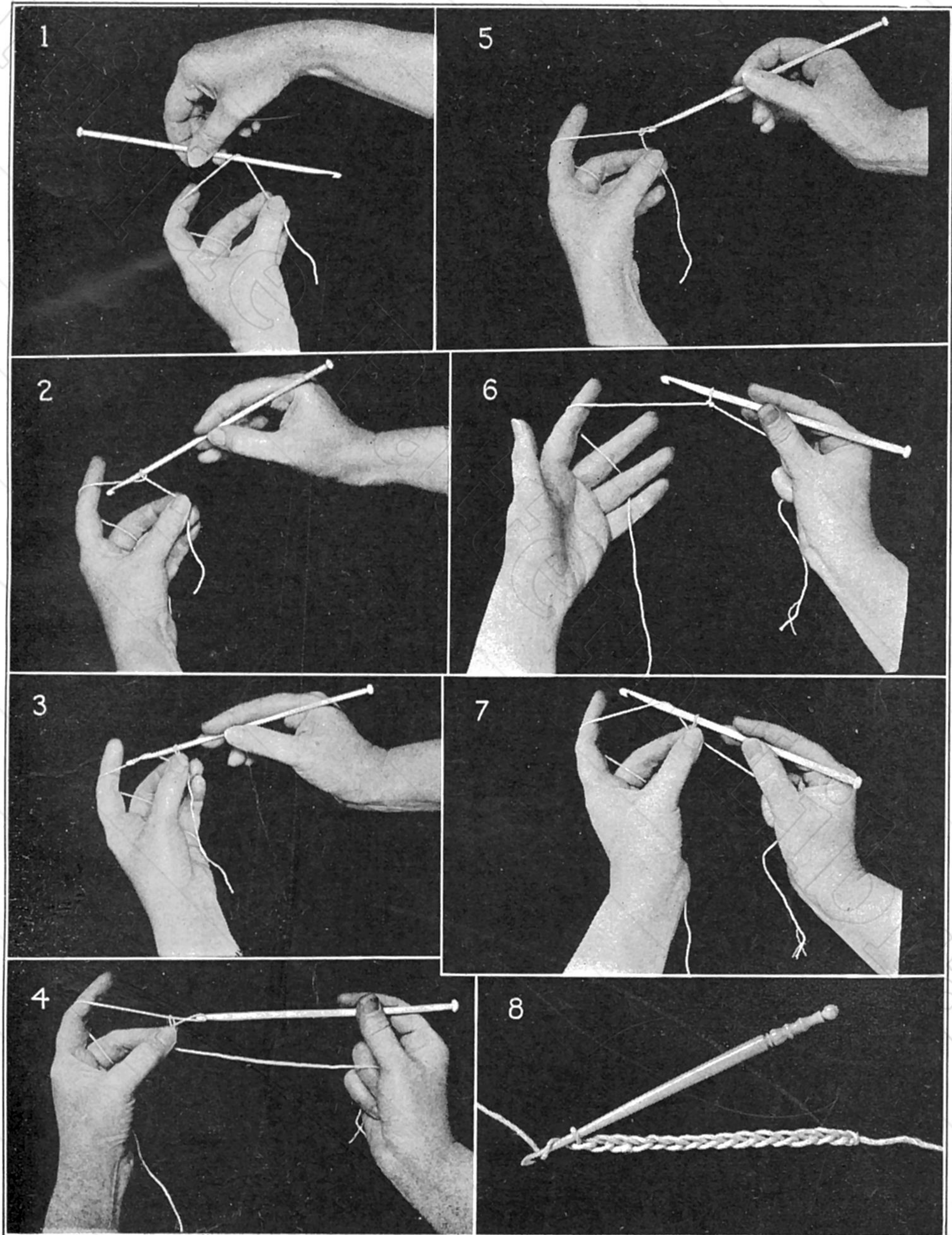

**PLATE 1—MOTION PICTURES SHOWING HOW TO MAKE CHAIN STITCH
SEE DESCRIPTION, PAGE 48**

Antique Pattern Library

This time Mary Frances thought Crow Shay grinned at her. Then his face melted away, leaving nothing but the upturned line of his grin.

"My," thought the little girl, "if he keeps on, I shall be sure to laugh;" but she paid strict attention to what her aunt told her.

"To begin with," said Aunt Maria, "everybody who learns to crochet must learn how to make chain stitch. In order to learn how to make chain stitch you must do just as I have already shown you."

Mary Frances tried again and again and was able at length to make chain stitch very well. She knew that Crow Shay helped her.

"Even though I seldom played with dolls when I was young," said her aunt, "I believe that I can show you how to make some pretty necklaces for dolls by using this stitch. I used to make them and give them to my friends for their dolls."

"Oh, how, Aunt Maria?" cried Mary Frances, delighted with the thought. "I'd just love to make one for Mary Marie!"

"Perhaps in this way," said her aunt, giving her directions for making—



His face
melted
away.



"Oh, how, Aunt Maria?"

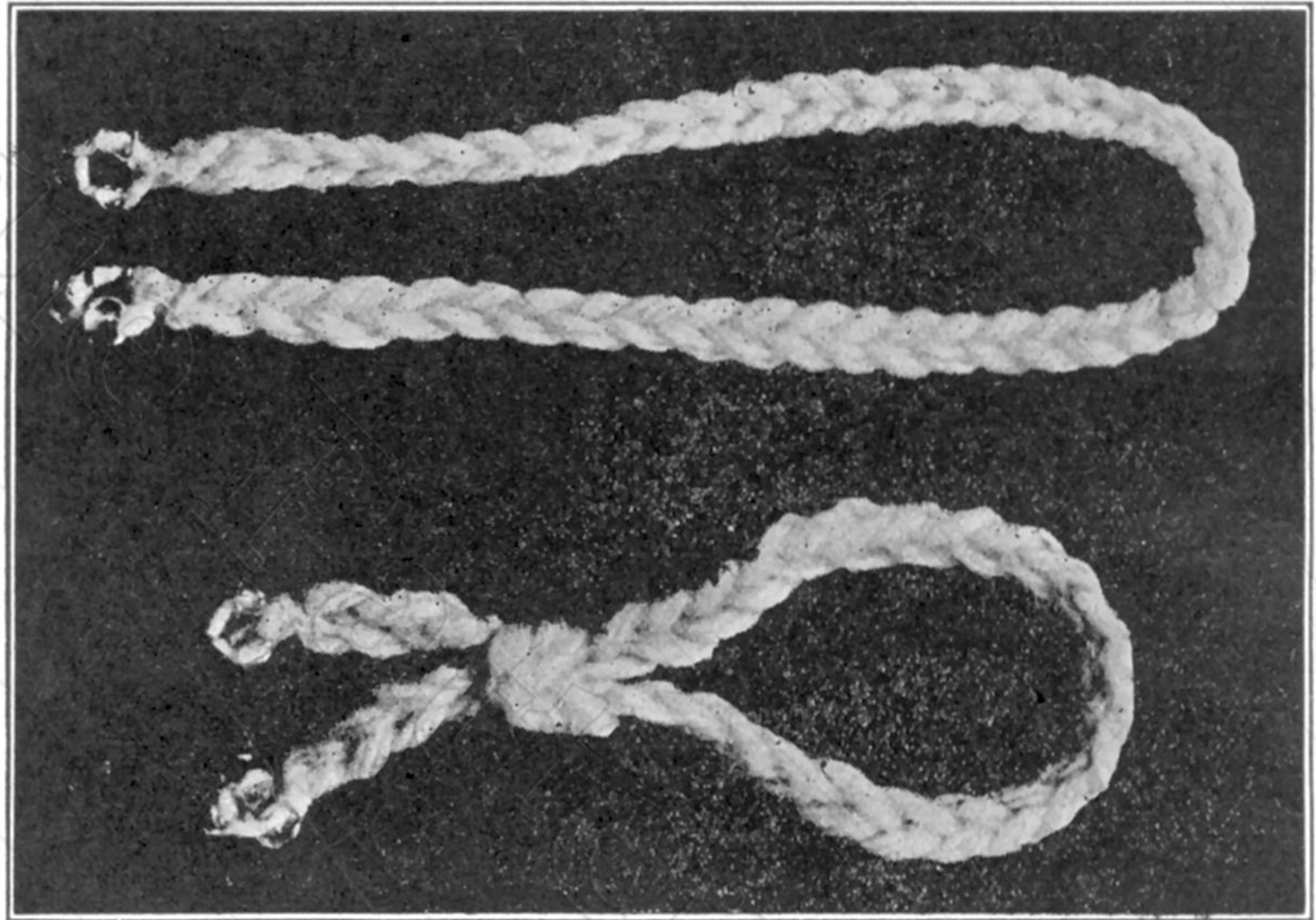

DOLL'S CROCHETED NECKLACE

Material: Pink or light blue or yellow Germantown zephyr.
Six glass beads with large stringing holes.

Needle: Bone crochet hook No. 5.

Directions: Leaving an end of about 3 inches, make a length of about 60 chain stitches.

When fastening off the work, leave a 3-inch end of yarn.

Thread a long-eyed needle with the end of yarn hanging from one end of necklace, and string three beads upon it. Fasten end

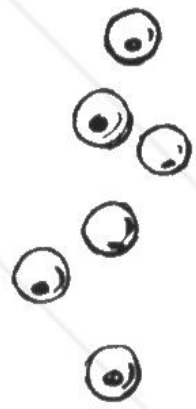

Six glass beads.



A Doll's Necklace.

A DOLL'S NECKLACE

51

of yarn securely into the end chain stitch. Do the same to the other end of the necklace.

Tie the two ends of the necklace together around doll's neck.

"Oh, won't that be lovely for Mary Marie!" exclaimed Mary Frances. "I shall make one for her to-morrow. Thank you, Aunt Maria."

"Probably you will," said her aunt. "You certainly do learn quickly—just like me. You certainly are very much like me. I always learned such things quickly."

"Now," she continued after a little pause, "now, watch me, and learn how—

TO MAKE SINGLE CROCHET

Material: Germantown wool.

Bone crochet hook No. 5.

Make a row of 15 chain stitches.

CUT 1—Put the hook through the second chain stitch from the needle. (That is, skip one chain stitch.)

CUT 2—Draw a loop through the chain stitch, and wrap the yarn over the hook, and

CUT 3—Pull a loop through the two loops on the needle.

CUT 4—Keep on working in this way until you have made a row of single crochet stitches.



"You learn quickly."



"Oh, wont that be lovely!"

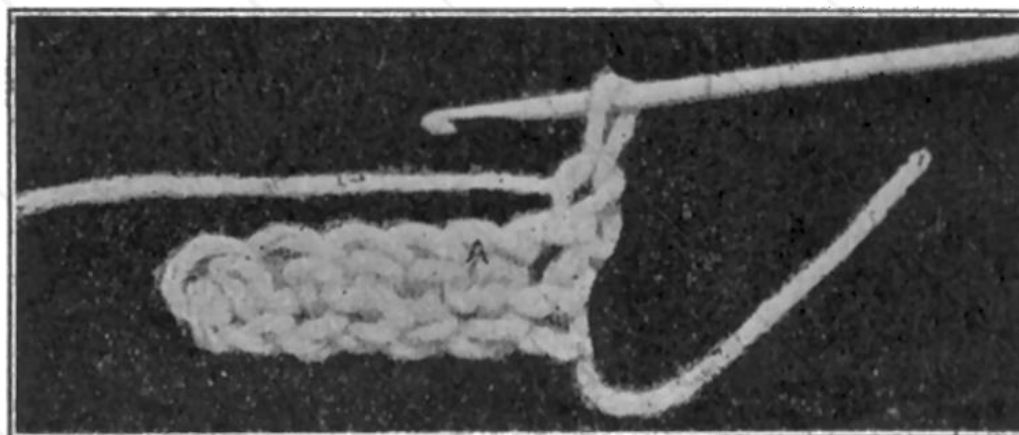

To Turn the Work

In making the second row (on top of the first row) make 1 chain stitch to use in turning; that is, make 1 chain stitch, and holding the needle still in the right hand, turn the work over to the wrong side so that the row just made points in the same direction as the needle. It is always necessary to use chain stitches in turning crochet work—to keep the edges even.

Put the hook through under both threads at the top of the next stitch (See "A" in the picture) and make a single crochet stitch. • Continue to make single crochet stitches across the row.

TO MAKE DOUBLE CROCHET

Material: Germantown wool. Bone crochet hook No. 5.

Make a row of 15 chain stitches.

Wrap the yarn over the needle, and put hook through the third chain stitch from the needle. (That is, skip 2 chain stitches.)

Draw a loop through the chain stitch, and wrap yarn over hook.

Pull a loop through 2 of the loops on the needle.

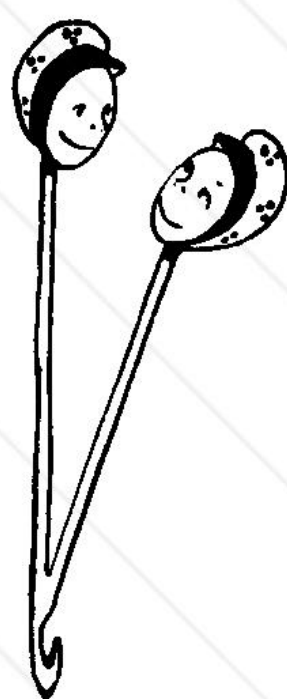

Double
Crow Shay

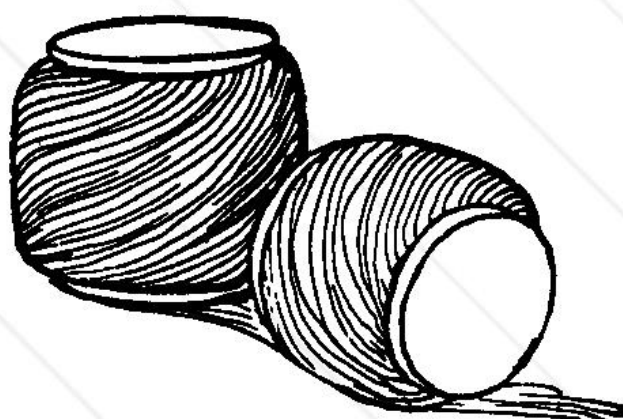

Crochet Cotton.

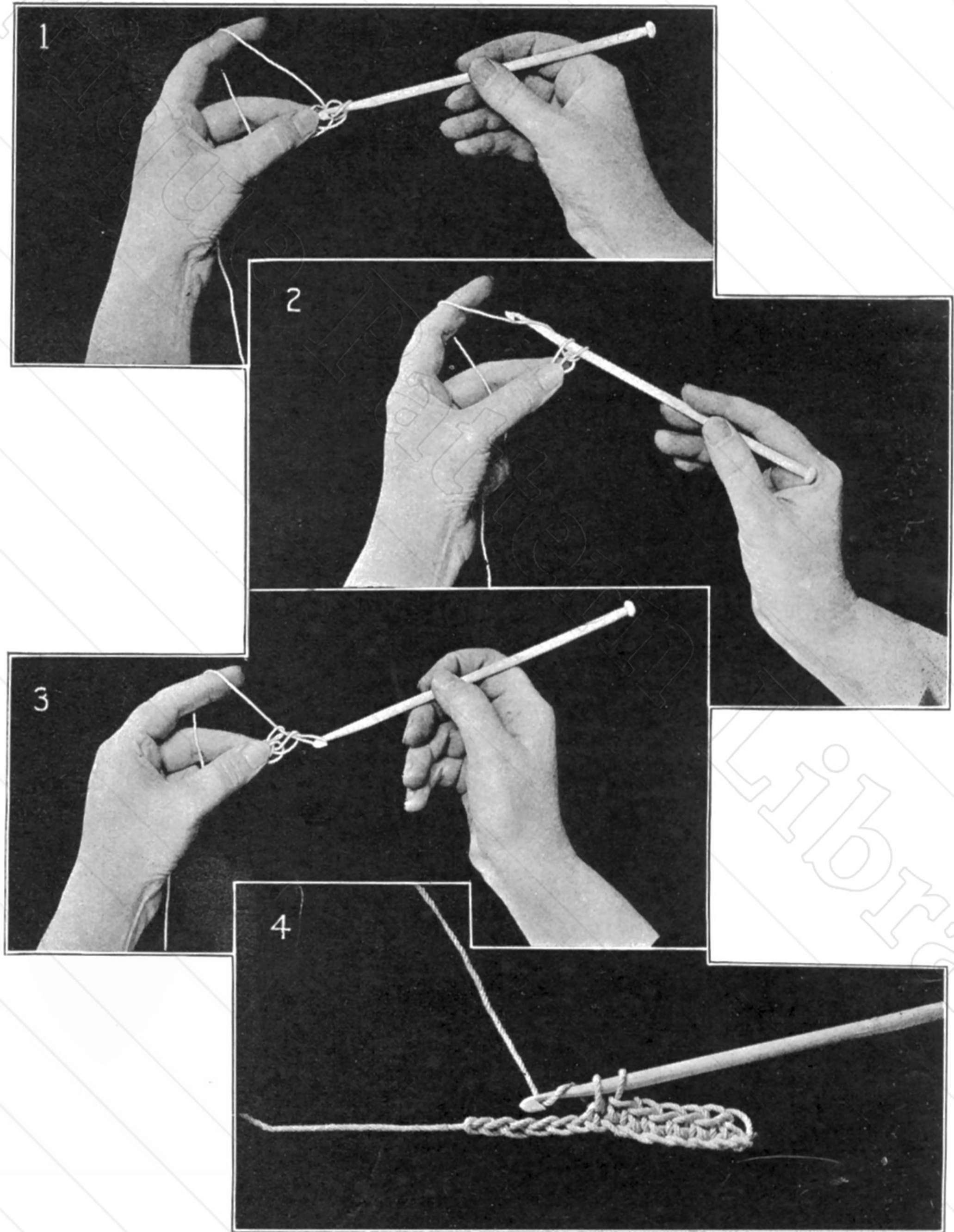
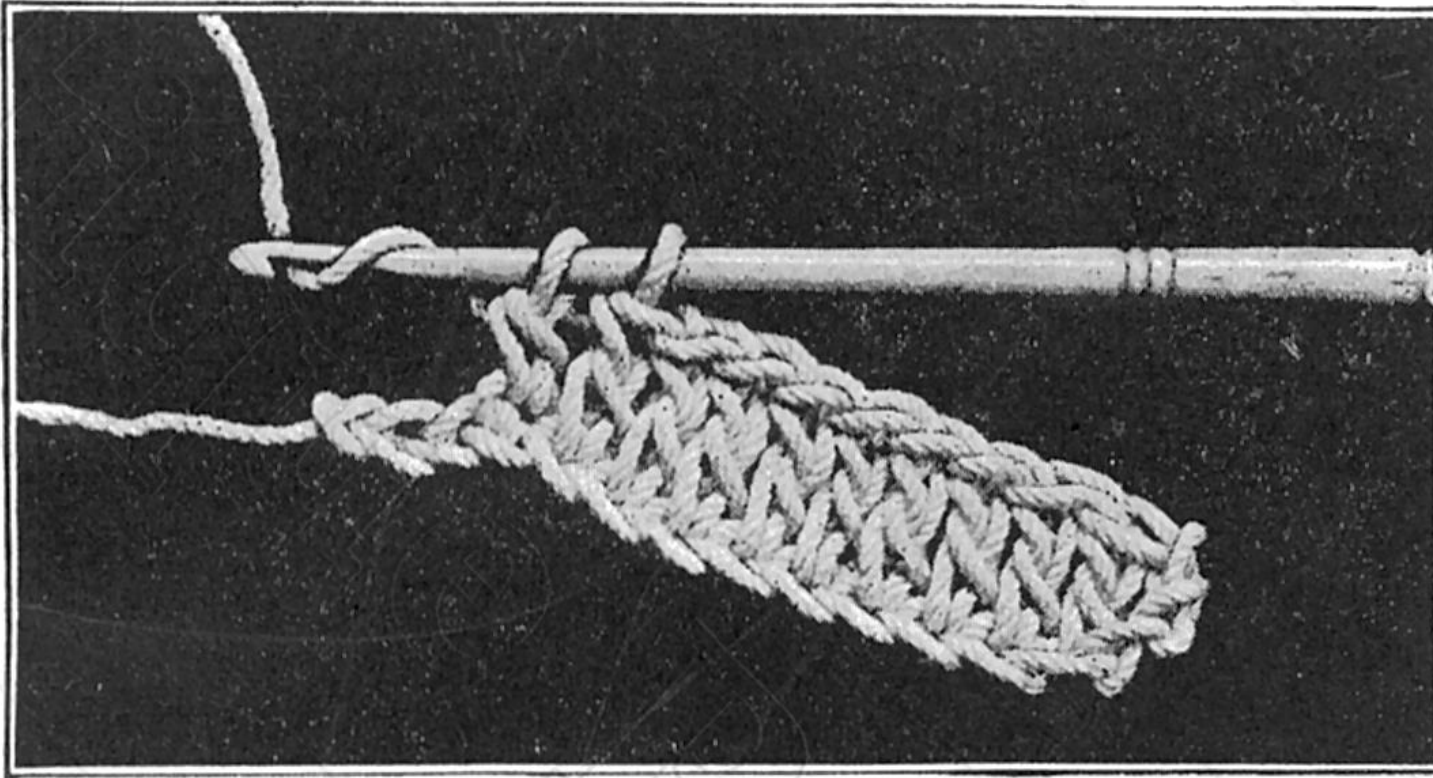

**PLATE 2—MOTION PICTURES SHOWING HOW TO MAKE SINGLE CROCHET
SEE DESCRIPTION, PAGE 51**

Antique Pattern Library

A DOLL'S NECKLACE

53



DOUBLE CROCHET

Wrap again and pull a loop through the 2 loops on the needle. Finish the row; turn the work; and make another row of double crochet stitches.

TO MAKE SLIP STITCH

Make 15 chain stitches. Skip one chain. Put the hook through the next chain stitch; wrap yarn over needle, and draw it through both loops on the needle. Continue to make slip stitches to end of chain. Turn the work, and make a second row.

He was a wonderful help.

As you may guess, Mary Frances had very little trouble in making these stitches, for Crow Shay was a wonderful help.



She only smiled.

“You are certainly quick at learning these stitches, my dear niece,” said her aunt. “I think—I really think that you have learned them even more quickly than I did.”

“I wonder what Aunt Maria would say if she knew about Crow Shay,” thought Mary Frances; but she only smiled, and kept on making single crochet stitches.

“That is all for to-night’s lesson,” said her aunt. “It is nearly your bedtime. I will walk home with you.”



Chain
Stitch



Took up the ball of yarn.

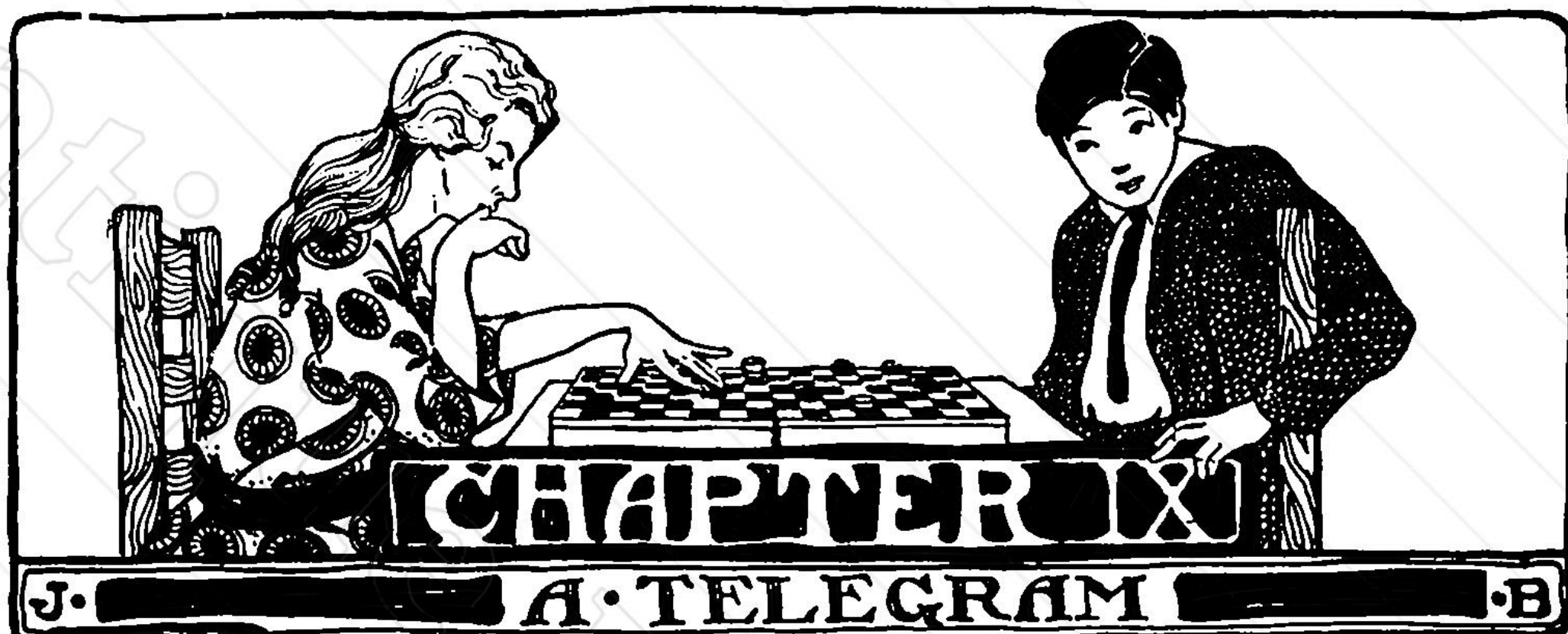

HE minute Mary Frances saw her mother she knew that something was wrong, for she looked so white and worried. In her hand was a yellow envelope.

"A telegram!" exclaimed Mary Frances. "Mother dear, is—is it—about father?"

"Oh, Mary Frances," said her mother. "I am so thankful to see you and Aunt Maria! I was just looking for Billy to send word for you to come."

"Do sit down, child," said Aunt Maria, "and tell us all about it. Mary Frances, bring your mother a glass of water, and here—here is my bottle of smelling salts."



So white and worried

[55]



"A telegram!"

Mary Frances flew to bring the water.

Then Aunt Maria read the telegram.

“Your father has been hurt in a railroad accident, my dear,” she said. “Your mother and I must start to him immediately. I will go pack my bag. You can help your mother get ready. I shall be back in a very short time. Billy will carry our bags to the train. Your mother is feeling better, or I would not leave you. Good-bye.”

And without any more ado the old lady was gone.

Mary Frances put her arms around her mother's neck.

“Dear little girl,” said her mother. “You will be brave and womanly, I know.”

“Yes, mother, I will!” said Mary Frances. “I will help you in every way I can. That is the best way of helping father. Come on upstairs, dear, and let me help you get ready to go to him. Do you feel able to go?”

“It is the very thing I want to do most of all. I am glad that Aunt Maria is going with me, though. I know I shall find her a wonderful help.”

Mary Frances packed her mother's suitcase, and



Aunt Maria
read it.



“Dear little girl”

fastened her dress, and buttoned her shoes, and put her hat and veil on. "Just as if I were your little girl," said her mother. "What a darling comfort you are, my dear!"

Billy and Mary Frances went to the station with their mother and aunt. Billy carried their luggage and bought their tickets. "No grown man could have done better," said his mother; and even Aunt Maria praised him.

"Now, children," said their mother, giving them their last directions, "Katie will be home about ten o'clock. You had better wait up for her. Poor, faithful soul, she will be as grieved as any of us about the sad news."

"But it isn't such sad news as it might be, mother," said Billy. "Father will soon be well, we hope."

"With the kind of nursing which I—I mean we—will give him," said Aunt Maria, "I expect he will be about quite soon."

That speech cheered everybody, and the children felt so hopeful that they were nearly happy as the train pulled out of the station.



Billy.



"Now, children."

The house seemed pretty empty and lonesome when they went in.

"Let's play checkers," said Billy; and they forgot a little of their troubles in the game.

It was not long before they heard footsteps on the porch. Then the bell rang.

"Oh, Billy, aren't you afraid to go to the door?" whispered Mary Frances.

"Afraid!" exclaimed Billy. "What's there to be scared of? You know it's Katie, most likely."

But Mary Frances noticed that he kept the toe of his shoe against the door, and opened it only a little way.

"Is it you, Katie?" he asked.

"It sure is," answered Katie. "That is, it's meself if I know meself."

"Oh, come in, come on in, Katie," cried Mary Frances; and with tears running down her cheeks, she told Katie the whole story.

"Poor little girl!" said Katie, holding her in her arms. "Don't you worry. We'll probably hear good news from your mother in the morning. Come now, let's all go to bed."



"Come in
Katie."



"It sure is."

Katie was right. The morning brought another telegram. It said:

Father is not dangerously hurt. Will write about everything.

Mother.

"Oh, Katie! Oh, Billy!" cried Mary Frances. "I am the thankfulest of all thankful children in the world, I guess. I feel happy enough to kiss a crow!"

"Well, I'm thankful enough to play a game of ball," said Billy, starting off.

"And I'm thankful enough—to clean house," said Katie.

Mary Frances offered to help her, but Katie said, "Oh, you just keep to your own knitting, little girl. If I need you I'll call upon you, thank you."

"The very thing!" thought Mary Frances and went upstairs.

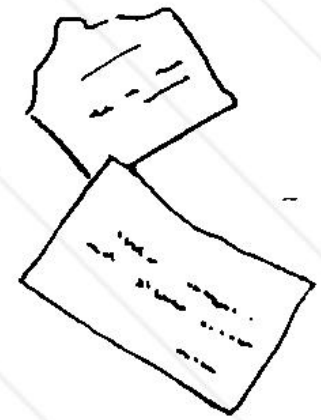

Another telegram



"The very thing."



"You work pretty well."

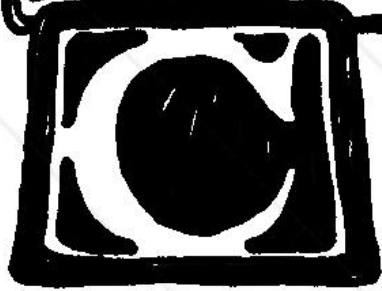

ROW SHAY was peeping out of the knitting bag.

"I told them all about it," said he. "I told all about how well you learned your stitches."

"If you hadn't helped me," Mary Frances said; "if I hadn't had such a kind, helpful friend, I never would have done as well as I did."

"Not for to-day,
But every day,
I'll be your little friend,
Crow Shay,"

promised the little fellow, again breaking into rhyme.

"So will all of us," said the Yarn Baby.

[61]



Peeping
out.



"So will all of us."

"Isn't that lovely!" Mary Frances exclaimed.
"Now that Aunt Maria is away——"

"Oh, did she get off?" asked Wooley Ball.

"Yes; she's off," said Crow Shay. "She's off—
and she's awful!"

"Oh, for shame!" cried Mary Frances.

"I meant to teach you the stitches myself," mut-
tered Crow Shay. "That's why I said she was
awful."

"You must not speak in that way of any of my
friends," said Mary Frances. "Aunt Maria is very
good to me. She even told me how to make a neck-
lace for my doll."

"Is that all she told you how to make for your
doll?" asked the Yarn Baby, sitting up suddenly.

"Why, yes; you see I do not know how to make
many different kinds of stitches yet," said Mary
Frances.

"She knows how to make chain stitch, slip stitch,
single crochet and double crochet," said Crow Shay.

"Well, if you know that much," went on the Yarn
Baby, "we can teach you how to make lots of things
for your doll, if you will just follow our directions."



"She's off—
and she's
awful!"



"Oh, did she get off?"

“Won’t that be splendid!” Mary Frances was delighted. “I can begin right away,” she said.

“Mary Marie needs so many things,” she went on. “I do wish that the child had all the nice warm things she needs.”

“How large is she?” asked the Yarn Baby.

“Not quite sixteen inches tall,” replied Mary Frances. “I would bring her in from the playroom, but I want to surprise her if I make anything for her.”

“Of course,” said Wooley Ball. “We understand that.”

“Yes,” said the Yarn Baby, “and we will make everything just the right size for her. How would you like to make her a scarf to wear around her neck when it is cold?”

“Why—could I make a scarf with just the few kinds of stitches that I know how to make?” asked Mary Frances in surprise.

“Indeed you could, and indeed you can,” laughed Wooley Ball. “It is splendid to think of your having so many beautiful yarns,” she added.

“Yes,” said Mary Frances, “my grandma sent me all she had. She kept the yarns which were left



A
scarf.



How large is she?”

over from her work for years. Some of them are lovely. I meant to have them all wound into balls for this lesson, but I haven't had time to do it."

She opened the little chest, and you can imagine her surprise when she saw only neatly wound balls, instead of loose odds and ends and hanks and skeins of yarn.

"Why, who in the wide world did this?" she exclaimed.

"It makes me sigh
To say, 'Not I,'"

sang Crow Shay.

"I am afraid it would make you die not to say anything," said Wooley Ball.

"Oh, Wooley Ball
Knows best of all
How to make yarns
Into a ball,"

sang Crow Shay, laughing.

"How did you ever do it. Wooley Ball?" asked Mary Frances. "I do thank you so much."

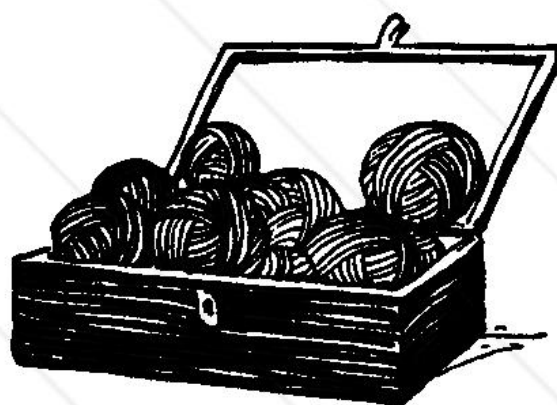
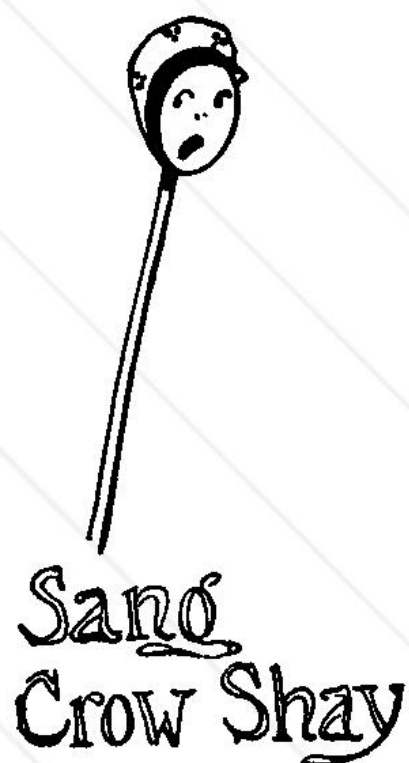

Neatly wound balls.

“Wooley Ball is in charge of all the yarns,” the Yarn Baby explained. “They all obey her.”

“When I say,

‘All, all
Go into a ball,’

they wind themselves,” said Wooley Ball.

“Did you ever go to a ball?” asked Crow Shay. “I have. I’ve gone to a ball, and I’ve used it all up. Oh, I am a grand ball player!”

“You are too silly for words sometimes,” said the Yarn Baby. “Now you will soon have a chance to show how you play ball!”

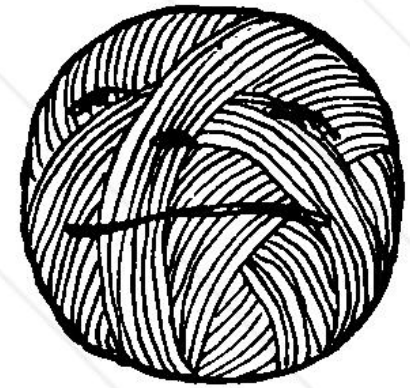

“All, all
go into a
ball”



“You are too silly.”



Mary Marie.



HAT color would you like to use for Mary Marie's scarf, little Miss?" asked the Yarn Baby.

"I think this is pretty," answered Mary Frances, lifting a ball of rose-colored Germantown zephyr.

"Mary Marie arose, arose,
'A rose,' she cried, 'A rose
Scarf, I propose,' "

said Crow Shay.

"Will you keep still!" screamed the Yarn Baby, her hair standing out in all directions. At least she tried to scream, but her voice sounded like a zephyr

Mary Marie
arose, arose

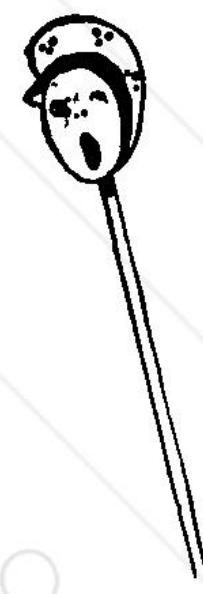

"Will you keep still!"

wind. "You are so full of mischief, I don't see how you will do any work to-day," she added.

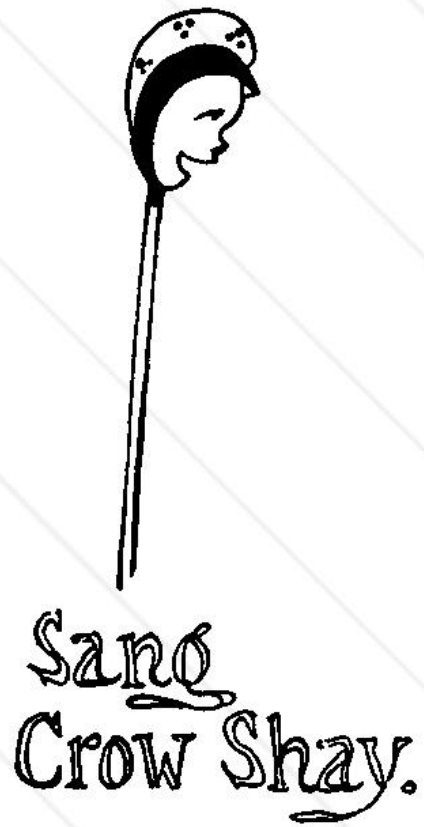

"I love to work,
I never shirk,
Nor do I jerk my
work
When I do work,"

sang Crow Shay.

"You generally do work pretty well," admitted the Yarn Baby, "but you are pretty slow some-times."

"We haven't been very fast about getting those directions," said Crow Shay.

The Yarn Baby took the hint and gave the directions for—



"You work pretty well."

A ROSE SCARF

69

DOLL'S CROCHETED SCARF

(See picture opposite page 40—color plate)

Material: Rose color, or blue four-fold Germantown zephyr.
Gray Germantown zephyr for trimming.
Bone crochet hook No. 5.

Directions:

1. With the rose or blue wool, make 7 chain stitches. Turn the work.
2. Skip 1 chain stitch. Make 6 single crochet stitches into the 6 chain stitches. (See picture of single crochet stitch, opposite page 51.)
3. Make 1 chain stitch to use in turning for the next row of stitches; that is, after having the chain stitch on the needle, turn the work over, and work on the other side.
4. Make 62 rows of single crochet stitches, putting the crochet hook through the 2 threads or loops at the top of each stitch of the row below.
5. Break off the yarn, and fasten the end by making a chain stitch and pulling the yarn all the way through the chain stitch.

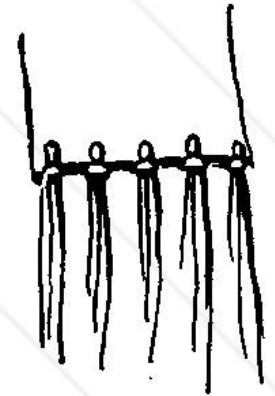

Fringe

To Make Fringe

(See picture on page 70)

1. Cut 2 strands of gray wool, making each 3 inches long. Lay them together, side by side.
2. Put hook through the first stitch on one end of the scarf.



Dolly's Scarf.

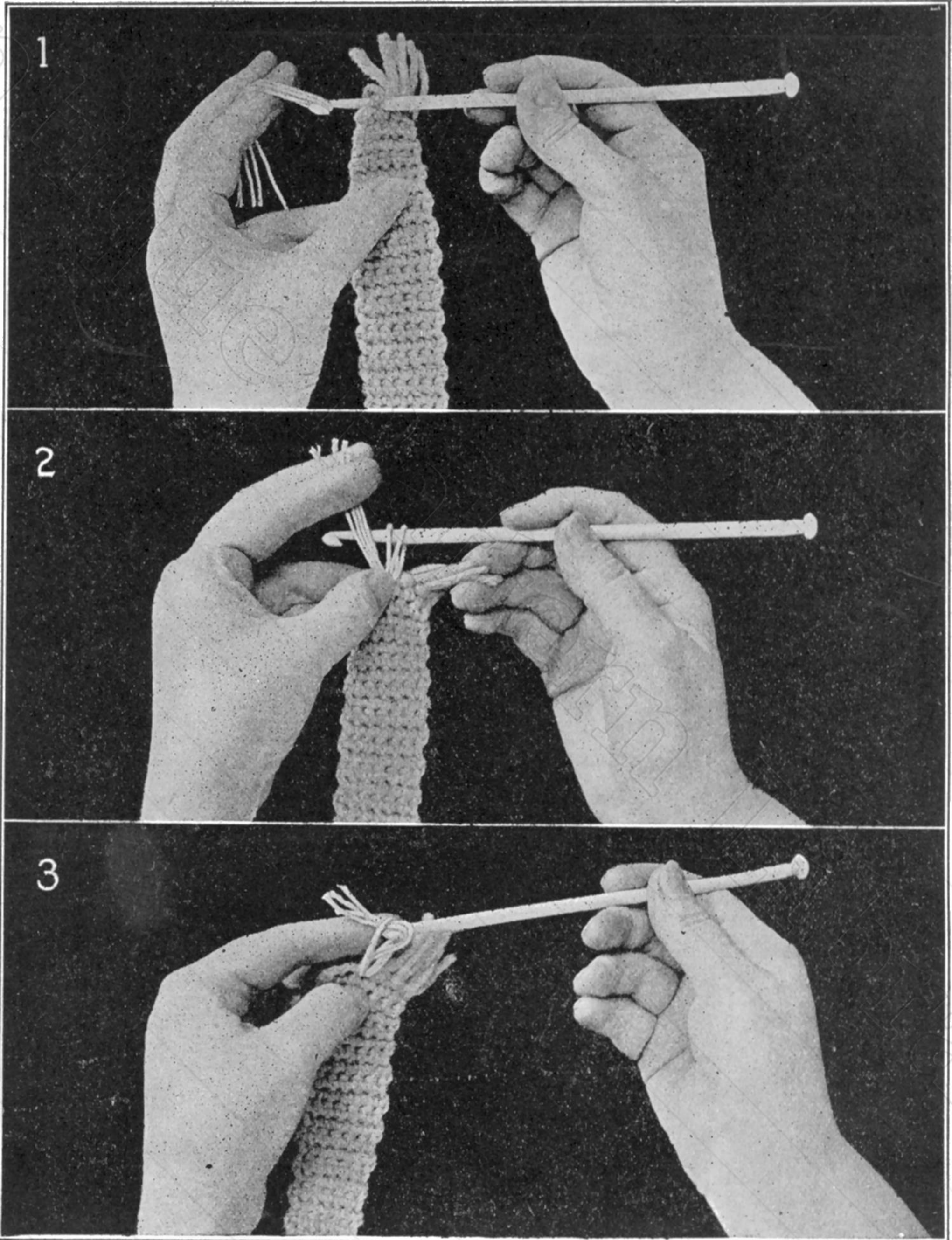

HOW TO MAKE FRINGE

A ROSE SCARF

71

Catch the 2 strands of gray yarn in the middle. Pull part way through the stitch.

3. Throw the 4 ends of wool over the hook and pull them all the way through the loop on the needle.

4. Take hold of the 4 ends of gray wool with the finger and thumb of your right hand, holding scarf between first finger and thumb of left hand with thumb close to the loop of the fringe. Pull gray yarn until the loop is tight.

Always pull the fringe through from the same side of the work.

5. Continue making fringe all across the two ends of the scarf.

Mary Frances worked hard, and Crow Shay helped with all his might, but the little girl's fingers seemed very awkward.

"Little Miss, you are doing nicely, but you pull the yarn too tight," said the Yarn Baby, who was watching her work most carefully.

Mary Frances noticed how smooth her hair looked. She knew the Yarn Baby was not displeased.

"I know I hold my work tight," she said. "My fingers just won't let go of the yarn."

"If you are inclined to make your stitches too tight, use a larger crochet hook," said the Yarn Baby.

Crow Shay looked so frightened that Mary Frances wanted to laugh; but she was afraid that if she did it



Crow Shay
looked
frightened



"You pull the yarn too tight."

would hurt his feelings, so she only said, "I think that I can manage better soon."

"If your work curls up when you have finished," said the Yarn Baby, "lay it under a damp cloth or a damp towel over night. When it is dry it will be quite smooth."

"Dampness always takes the curl out of my hair," laughed Mary Frances, working away.

The Crochet People helped whenever she made a mistake, and the Yarn Baby repeated the directions when she asked about them. She had not quite finished the scarf when Katie called her to lunch.



"Under a
damp cloth



Katie called her to lunch.



LET US PLAY BALL

FOR DIRECTIONS FOR MAKING KNITTED ARTICLES SHOWN IN THIS ILLUSTRATION SEE

CROCHETED SHAWL—75

KNITTED SHAWL—171

KNITTED SPORTS SWEATER—201

CROCHETED SPORTS HAT—240

Antique Pattern Library



AFTER helping Katie with the lunch dishes, Mary Frances ran upstairs again.

“How glad we are!
How glad we are!
We heard you coming
From afar!”

sang Crow Shay as she entered the room.

“We were afraid that you might not come again to-day,” said the Yarn Baby.

“Not come!” exclaimed Mary Frances. “Why, it would be punishment for me not to have these lovely lessons.”

“How glad we are!”



[73]



“Not come!”

Picking up Crow Shay, she finished putting the fringe on the scarf.

"Isn't it lovely!" she cried. "I want you all to see how sweet Mary Marie looks in it."

"Oh, let her nap,
Please let her nap,
Until you make—
A little cap!"

said Crow Shay.

"A cap?" asked the little girl. "Why, Crow Shay, do you think I can ever make her a cap?"

"Yes, indeed," answered the Yarn Baby. "We have planned that for a lesson to come soon."

"And we do not want to see your Polly—I mean your dolly—until you have the set made; that is, a cap and scarf. Then you can show us how she looks in them," added Crow Shay.

"Oh, all right," said Mary Frances, "that will be a much delightfuller surprise for Mary Marie, anyhow. I will work hard, and try to make the cap soon."

"Before doing that, you need a little more practice in plain work," said the Yarn Baby; "so how would



"Oh, let
her nap."



"Yes, indeed."

you like to make a pretty little shawl for your doll?"

"That is exactly what she has needed this very long while," declared Mary Frances.

"That's good," said the Yarn Baby. "Wooley Ball, what yarn have you planned for us to use for the shawl?" she asked.

"Two shades of light blue knitting floss," answered Wooley Ball proudly. "The floss will make such a pretty, soft shawl."

"Are you ready to begin?" asked the Yarn Baby as Mary Frances picked up the lighter blue floss and Crow Shay.

"Yes," replied Mary Frances, "all ready." But she wondered whether Crow Shay were not too coarse a hook to use for the floss.

"Now," said the Yarn Baby, "you will hear about the way to make a—

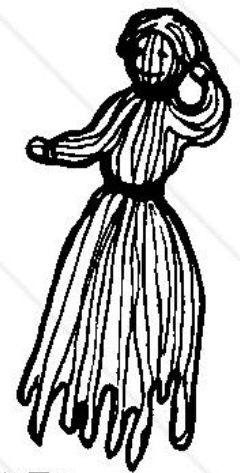

"That's good."

DOLL'S CROCHETED SHAWL

(See picture opposite page 72—color plate)

Be sure to make the Doll's Scarf, page 69, before attempting this work.

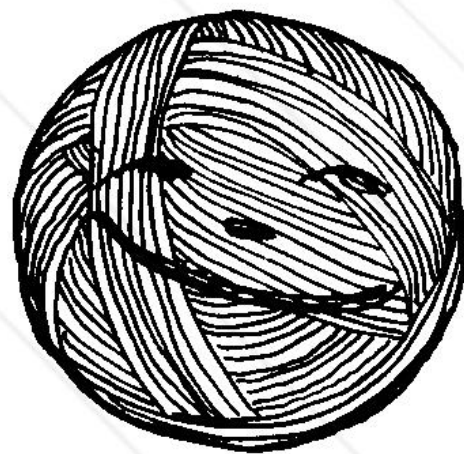

"Pink and white."

Material: Light blue (double) wool floss. Deeper shade of blue wool floss for trimming.

Bone crochet hook No. 3.

Directions:

1. Make 23 chain stitches with light blue floss.
2. Skip 1 chain stitch. Make 22 single crochet stitches.
3. Make 1 chain stitch to use in turning.
4. Make 4 rows of light blue floss, putting hook through the 2 loops at the top of each stitch in the row below. Break off the lighter floss and join the end with the deeper blue floss.

To Join Ends of Yarn in Crocheting

(a) Tie ends of yarn together. See picture below.

(b) When the work is finished, thread the ends of yarn into a long-eyed "crewel" or darning needle, and run the ends back into the work.

5. Make 2 rows of the deeper blue floss.

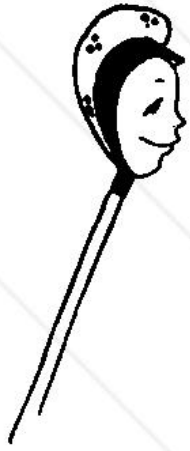

Use
Crewel Shay

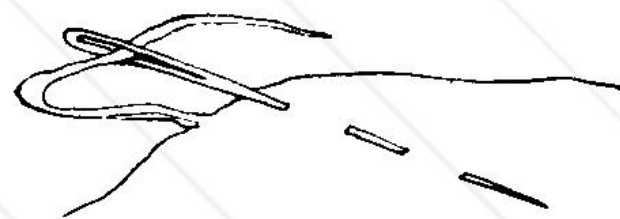
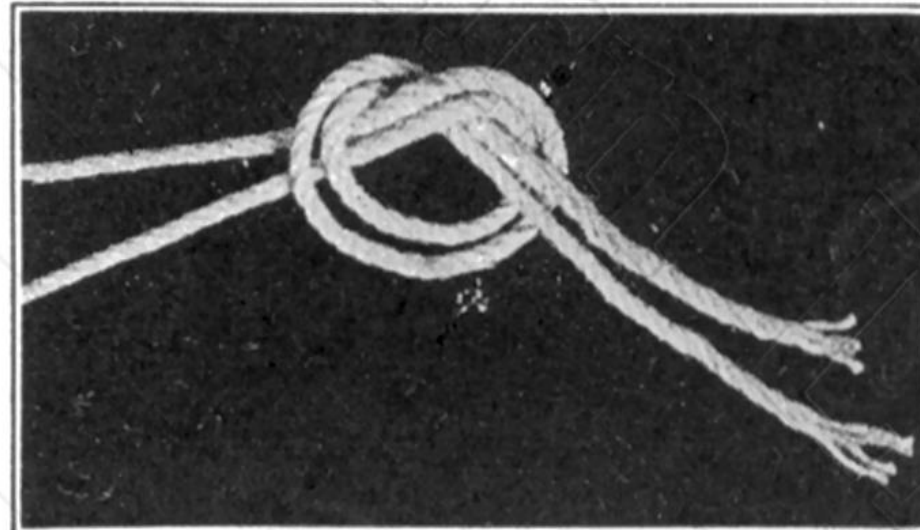

Run the ends into the work.

MARY MARIE'S SHAWL

77

6. Make 50 rows of light blue floss.
7. Make 2 rows of deeper blue floss.
8. Make 4 rows of light blue floss.
9. Break off floss and fasten end securely.
10. Trim shawl with fringe.

In Making the Fringe: Cut 4 strands of floss each 3 inches long. Draw strands through stitches in the same way as in making the fringe on Doll's Scarf.

"Oh, how I wish I could work faster," thought Mary Frances, starting to work. "I do not believe Crow Shay is the right size for this work anyhow."

"I am not," said Crow Shay, as though reading her thoughts. "I am too large!"

"Oh!" exclaimed Mary Frances. "Oh!"

"Oh, never mind,
I've had my turn;
I commenced
To help you learn,"

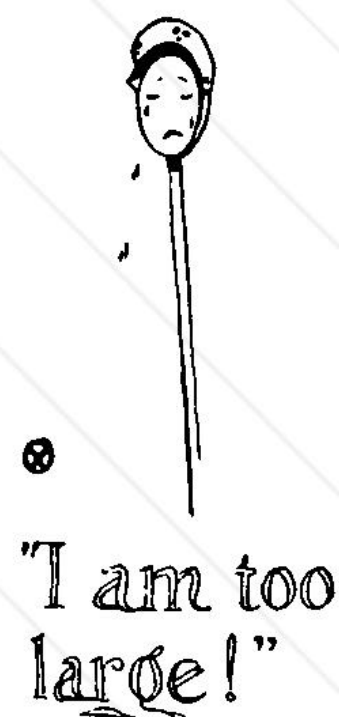

sang Crow Shay generously.

"And aren't you going to help me any more?" asked Mary Frances.



"Aren't you going to help me?"

“Oh, do not sigh,
And do not cry;
Some one will help you
Better than I,”

the little fellow sang again.

“Some one better than you!” exclaimed Mary Frances. “Why, all of you just suit me!”

“Not if you knew,
Not if you knew,
Our fairy teacher,
Fairly Flew,”



went on Crow Shay.

“Fairly Flew!” called the Yarn Baby.

“Tinkle! tinkle! tinkle!” came the silvery sound of clicking knitting needles from Mary Frances’ little chest.

“Did some one call me?” asked a still more silvery voice.

“Yes,” answered the Yarn Baby, “a dear little girl who is trying to learn how to crochet and knit needs you. She has worked so patiently that she deserves your help.”



“Better than you!”

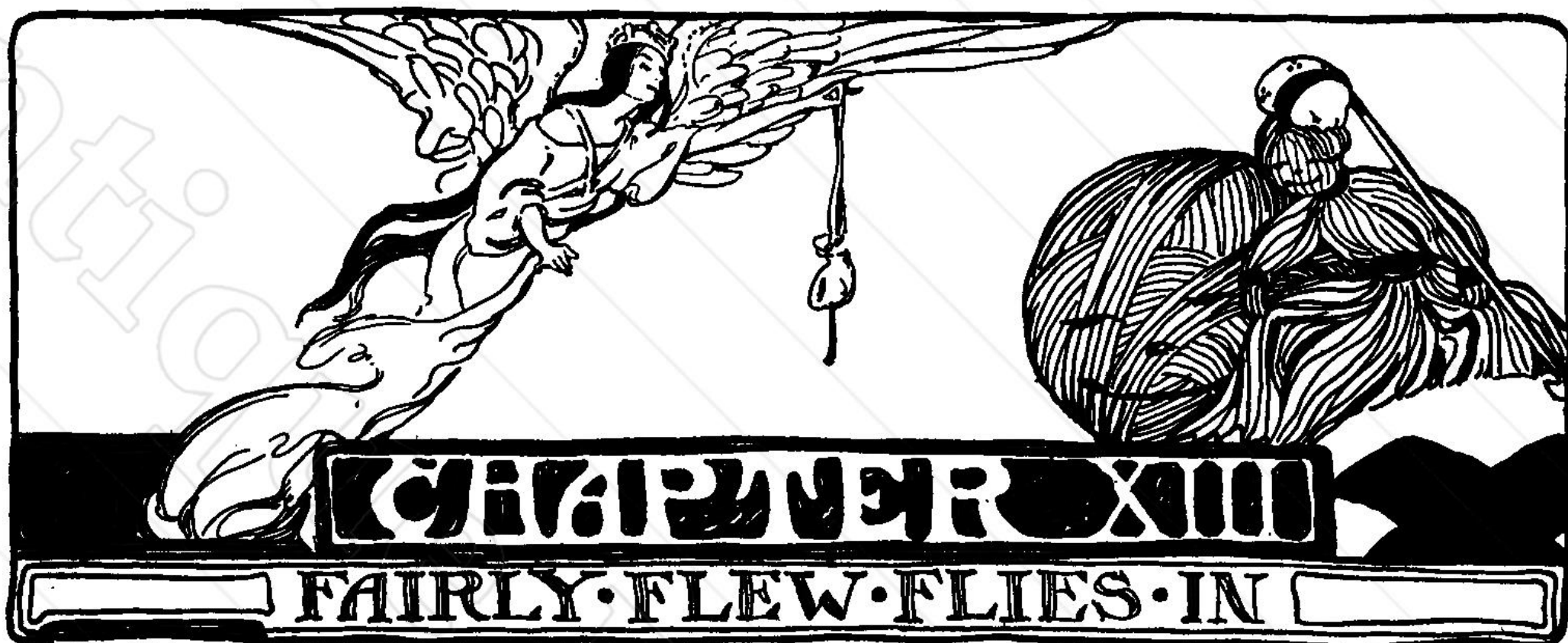

N

O sooner had the Yarn Baby finished speaking than out of the chest there flew a fairy!

She was so dainty and beautiful that Mary Frances felt that she would never dare to touch her.

Her dress was made of some silvery cobwebby stuff and she wore a golden cap.

"My name is Fairly Flew," she said, flying over on the table near to Mary Frances. "I love to help people who try to learn. I am the teacher of the Crocheting and Knitting People. If I lend you one of my magic needles, your work will go so fast that you will say that the needle fairly flew. That is how I came to be called Fairly Flew."



Never dare touch her.

[79]



Yarn Baby finished.

“Oh!” whispered Mary Frances, “another wonderful helper from Fairyland!”

“Yes,” laughed the silvery voice of Fairly Flew. “Ready to help, always ready to help those who try, try, try again. How can I help you?”

“If you please—” began the little girl. “If you please—” but she could seem to get no further.

Here the Yarn Baby spoke. All the Crocheting and Knitting People had risen when Fairly Flew arrived. Now, to Mary Frances’ astonishment, the Yarn Baby, who had always been the limpest of dolls, picked up Mary Marie’s little rocking-chair which was on the sewing table and placed it near the fairy.



“Take a seat.”

“Please take a seat,” she said, “for we need help, dear Fairly Flew, in making the doll’s shawl.”

“Oh, is that so?” laughed Fairly Flew. Then she put her hand down into her cobwebby pocket and pulled out a silver crochet hook with a handle only about an inch long.

She handed the crochet hook to Mary Frances.

“Take hold of its head and its heel, and pull,” she said.

Mary Frances was almost afraid to pull, but she



“Always ready to help.”

was very much pleased to find that when she did, the crochet hook became nearly as long as Crow Shay.

“Finish your work with my needle,” directed Fairly Flew.

Mary Frances was astonished at what happened. No sooner did she start to make a row of stitches than the magic crochet needle darted ahead of her fingers and finished the row in a twinkling of an eye.

In about sixty twinkles the little shawl was finished.

“Oh,” gasped Mary Frances, “Oh, isn’t it wonderful?” and she held it up for all to admire.

“Put it away, my dear,” said Fairly Flew. “I do not have very long to stay. A few hours a day is all the time I have for any mortal. So let us get everything done that we can.”



“Finish with
my needle”



“Isn’t it wonderful?”



Her hair began to stand on end.

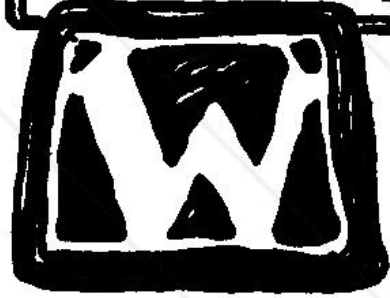

"HAT comes next?" Fairly Flew asked the Yarn Baby.

"Next," answered the Yarn Baby, "we planned to show the little Miss how to make another scarf for Mary Marie."

"Mary Marie hasn't two necks," whispered Crow Shay.

"Hush!" warned Wooley Ball as she noticed the Yarn Baby's hair begin to rise. "You will get into trouble if you don't!"

"There will be caps or hats made to match the little scarfs," went on the Yarn Baby, turning to Mary Frances. "You will know how to make this scarf as soon as you hear the directions:

[83]



"She hasn't two necks."

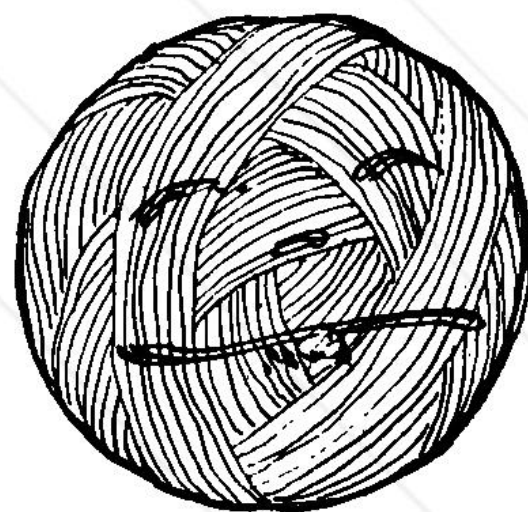

"Hush!" warned Wooley Ball.

DOLL'S CROCHETED WOOL FLOSS SCARF
(See picture opposite page 104—color plate)

Be sure to make Doll's Shawl, page 75, before attempting to make this scarf.

Material: Old rose wool floss. Gray floss for trimming.
Bone crochet hook No. 3

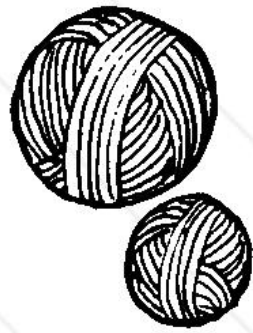

Old rose;
Gray floss



Directions:

1. With rose floss make 13 chain stitches.
2. Skip 1 chain stitch, and make 12 single crochet stitches.
3. Make 1 chain stitch to use in turning.
4. Putting hook through the 2 loops at the top of stitches just made, make 4 rows of the old rose floss.
5. Make 2 rows of the gray floss.
6. Make 2 rows of the old rose floss.
7. Make 2 rows of gray floss.
8. Make 90 rows of the old rose floss.
9. Make 2 rows of the gray floss.
10. Make 2 rows of the rose floss.
11. Make 2 rows of the gray floss.



Mary Marie.

12. Make 4 rows of the rose floss. Break off yarn and fasten. Trim ends of scarf with fringe.

Make the fringe exactly like fringe on ends of Doll's Scarf, page 70.

Mary Frances ound the old rose and gray flosses, and set about making the scarf. It was very little trouble, for the magic needle darted ahead just as in making the shawl, and very soon the little scarf was finished.

"Isn't it pretty?" cried Mary Frances. "How happy I shall be to make the caps or hats. Do they come next?"

"No," answered the Yarn Baby, "not yet."

"I will tell you why," said Fairly Flew. "It is because they would be too difficult for you to make now. You must learn to make the simplest things first. Then you will climb right up in the work."

"She hasn't made anything in double crochet stitch," Crow Shay whispered to Wooley Ball.

"I know," whispered Wooley Ball. "Wouldn't it be nice if she could make her dolly a warm petticoat with double crochet stitch?"



"No,
not yet."

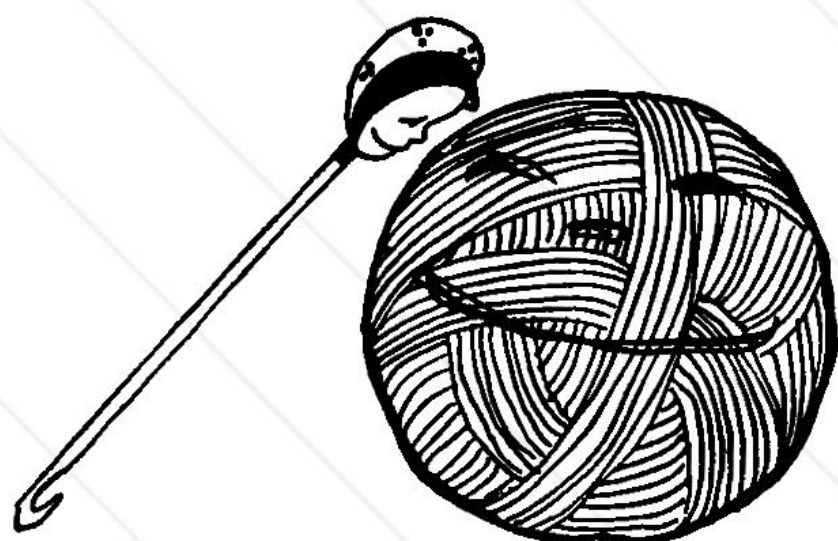

Crow Shay whispered.

“Indeed it would,” Crow Shay whispered again.
“I often wish I had one.”

“Had what?” asked Wooley Ball.

“A petticoat, of course,” Crow Shay answered.

“That is just what comes next,” said the Yarn Baby, overhearing, “and I will give the directions at once.”



“I wish I
had one.”

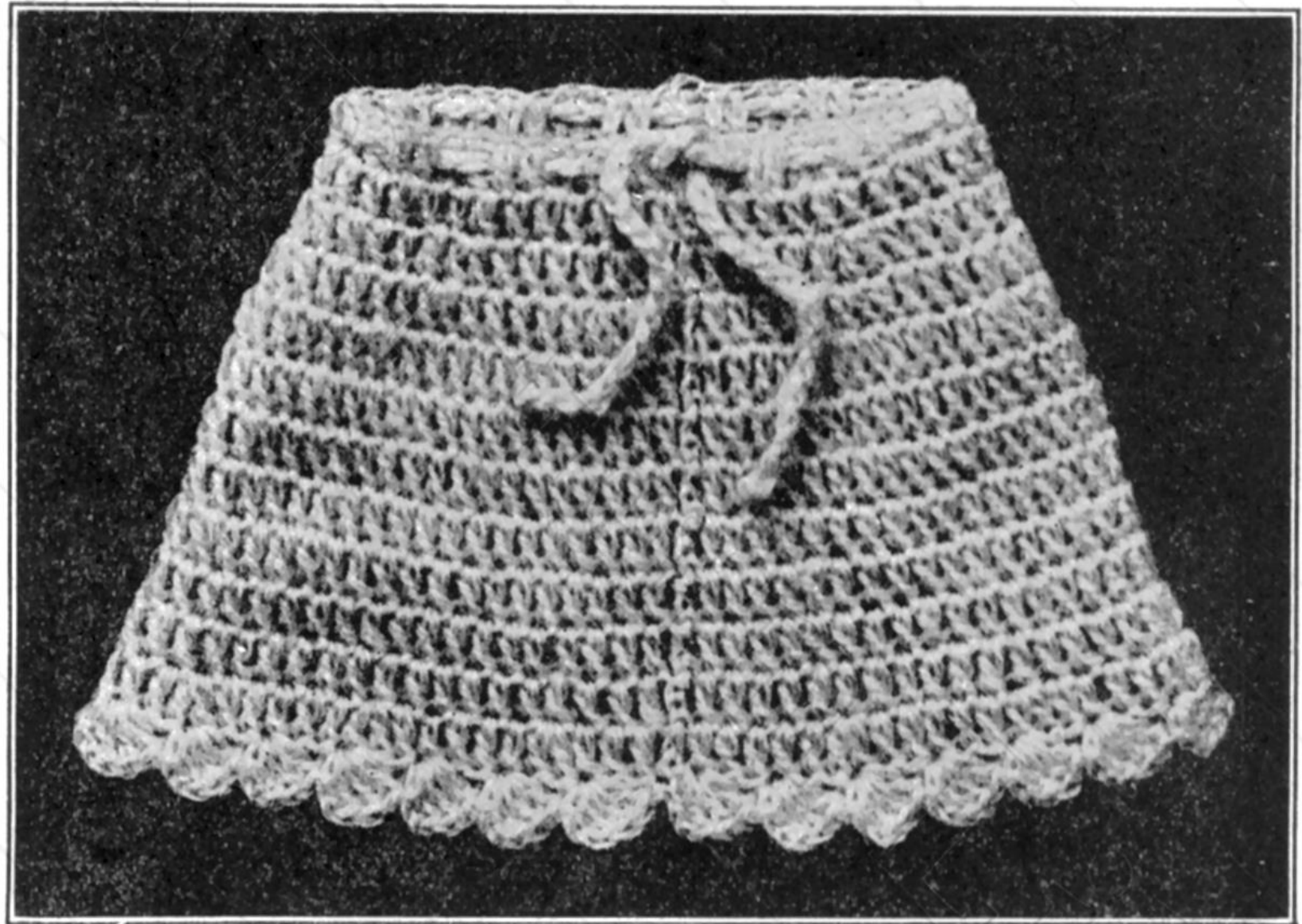

DOLL'S PETTICOAT



“Just what comes next.”



READY FOR BREAKFAST.

DOLL'S CROCHETED PETTICOAT

(See pictures on pages 86 and 87)

Made by working round and round from top downward.

Material: White wool floss.

Bone crochet hook No. 2.

Directions:

1. Make 48 chain stitches.
2. Join the last chain stitch to the first chain stitch with a slip stitch. (See picture below—A.)



Crocheted
petticoat.

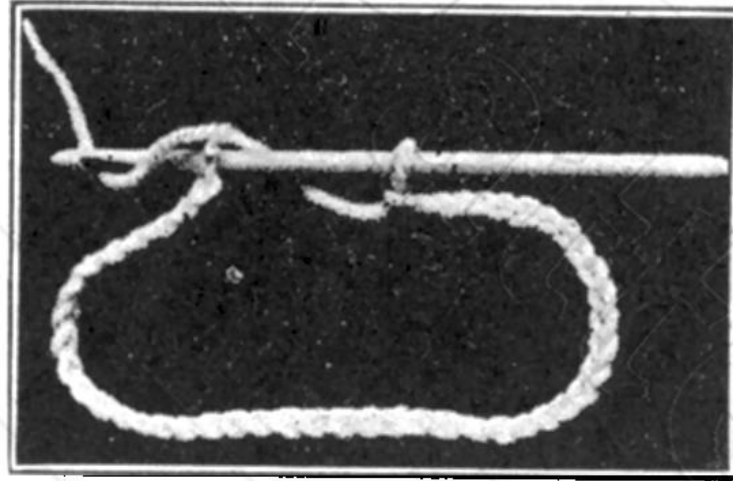

A

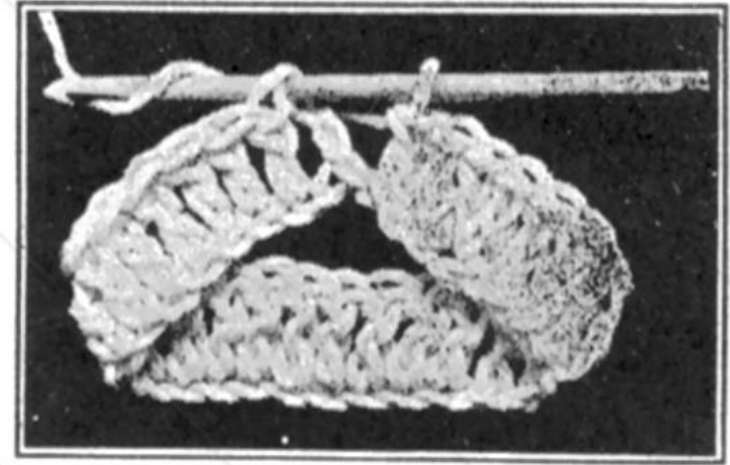

B

3. Make 3 chain stitches.
4. Put 1 double crochet stitch (see page 53) into each chain stitch. Join the last double crochet stitch with the top of the 3 chain stitches (see direction number 3, above) with a slip stitch. This makes the first row of stitches. (See picture above—B.)
5. Second row: Make 3 chain stitches, and make 1 double crochet in each stitch of first row putting hook under both threads. Join, as in first row.

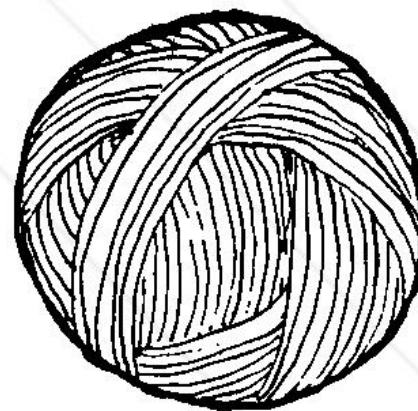

White wool floss.

How to "Increase" in Crocheting

6. Third row: Make in same way as second row, but increase, or widen, the petticoat by putting 2 double crochet stitches in every sixth stitch.

7. Fourth row: Like third row.

8. Fifth row: Like third row.

9. Sixth, seventh, eighth, ninth, tenth and eleventh rows: Like second row—that is, with no widening or increasing.

10. Twelfth and last row: "Increase," by putting 2 double crochet stitches in every sixth stitch.

Trim bottom of petticoat with scallops

To Make the Scallops

1. Put 1 single crochet stitch in the first double crochet stitch made on the twelfth row.

2. Make 2 chain stitches.

3. Put 3 double crochet stitches in the same stitch where the 1 single crochet stitch was put.

4. Skip 2 double crochet stitches in the last row of double crochet stitches of the petticoat. Put 1 single crochet into the third stitch.

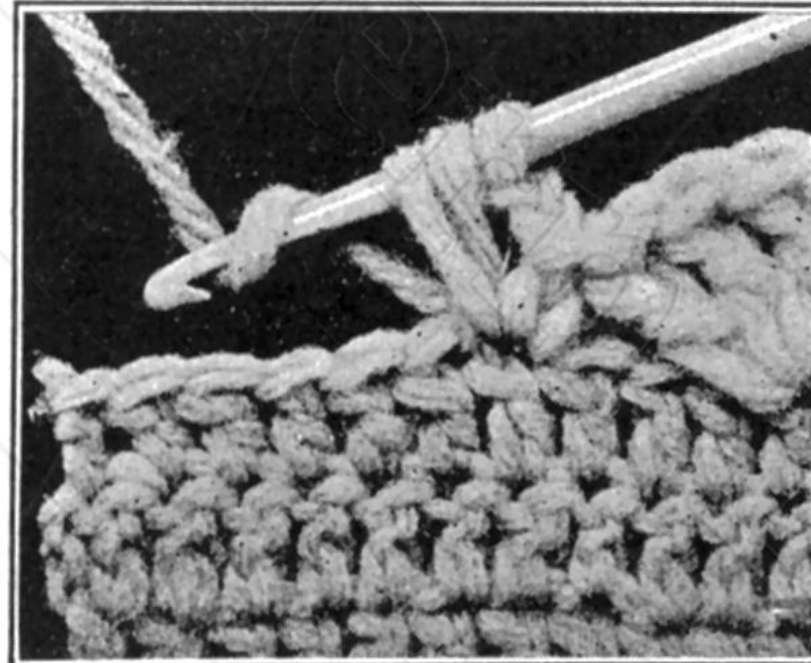

Crow Shay
looks on.



Scallops.

5. Make 2 chain stitches.

6. Put 3 double crochet stitches into the same stitch as the single crochet.

Continue in same way until scallops are made all around the petticoat.

Fasten the petticoat at waist with a runner.

To Make the Runner

1. Cut a piece of floss about 1½ yards long.

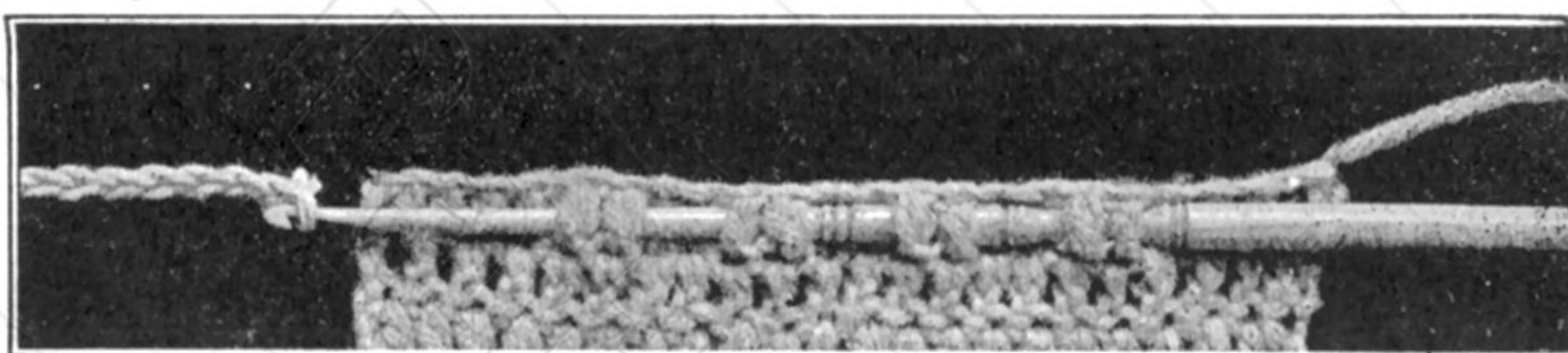

2. Fold it in the middle, and with the doubled floss, make a long chain of chain stitches.

3. Putting the crochet hook through the stitches at the top of the petticoat, pull the runner through. (See picture above.)

"How lovely and warm!"

"How lovely and warm Mary Marie will be!" exclaimed Mary Frances as she finished the little petticoat with the help of Fairly Flew's magic needle.

"Do not let her wear that in summer," said the Yarn Baby.



"Do not wear it in summer."

“If you do she’ll surely roast
And be eaten up for toast,”

added Crow Shay. Then he looked around to see if anyone would chide him for speaking.

Just as he expected, the Yarn Baby’s hair began to stand up on end; but Fairly Flew only laughed and said, “Oh, now, Yarn Baby, don’t get ruffled. Let him make a little fun for us all.”

The Yarn Baby’s hair settled down smoothly in place, and Crow Shay did look as though he would like to crow for sure, but he was very polite and kept quiet.



He looked
around.



Her hair began to stand on end.



"You surely will surprise them."



"HAT now?" asked Fairly Flew.
"Next," said the Yarn Baby, "comes
what the little Miss has been wanting so

much—

DOLL'S CROCHETED TOQUE OR CAP

(See pictures opposite page 104—color plate)

Material: Old rose (double) wool floss. Gray floss to be used in making pompons.

Bone crochet hook No. 2.

Directions:

1. Make 50 chain stitches. Join the last chain stitch to "What the first chain stitch with a slip stitch.
2. Make 50 single crochet stitches and work around for "NOW?" 20 rows. (See figure A on page 94.)

[93]



Make a doll's toque or cap.



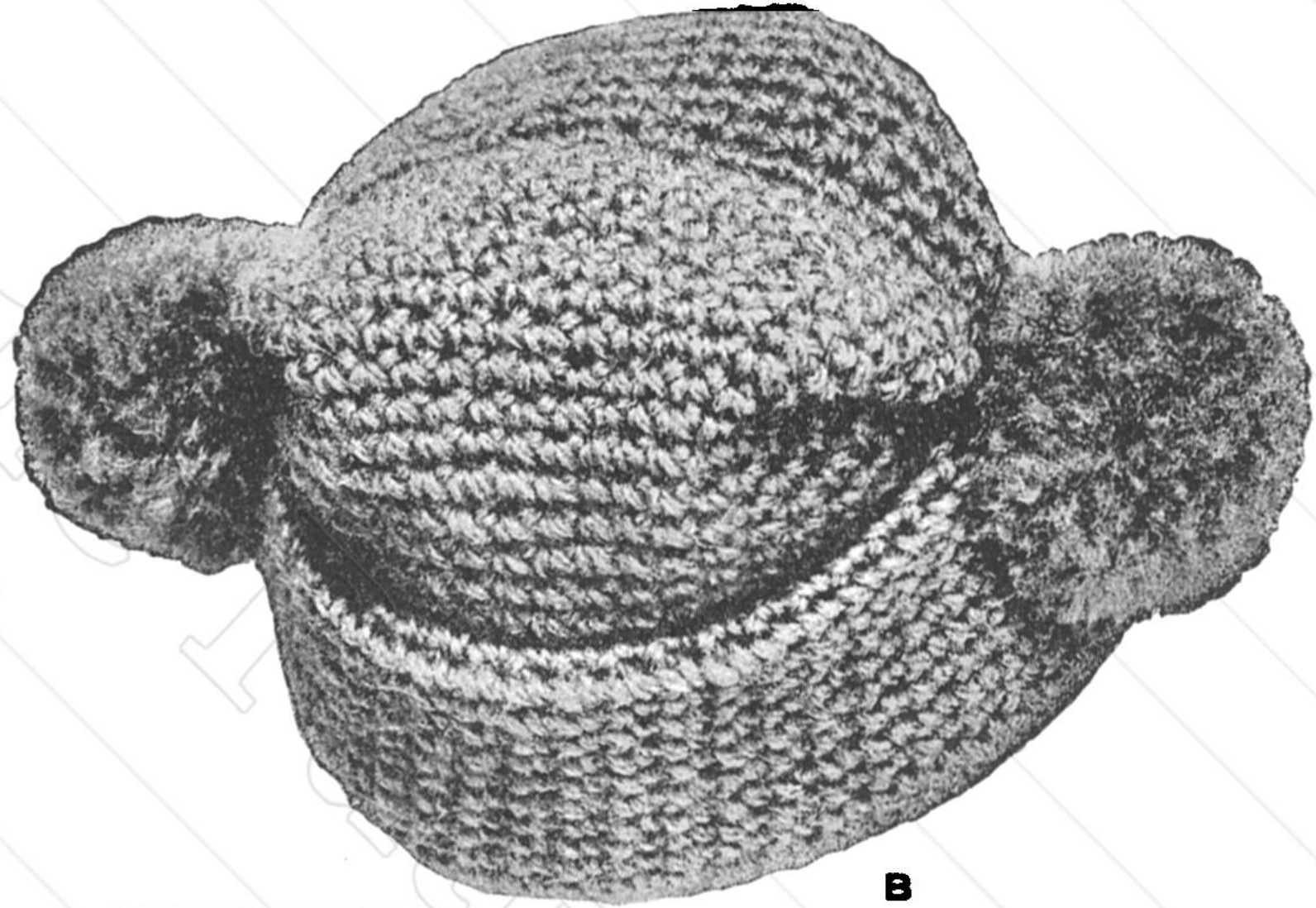

B



"Look at this."

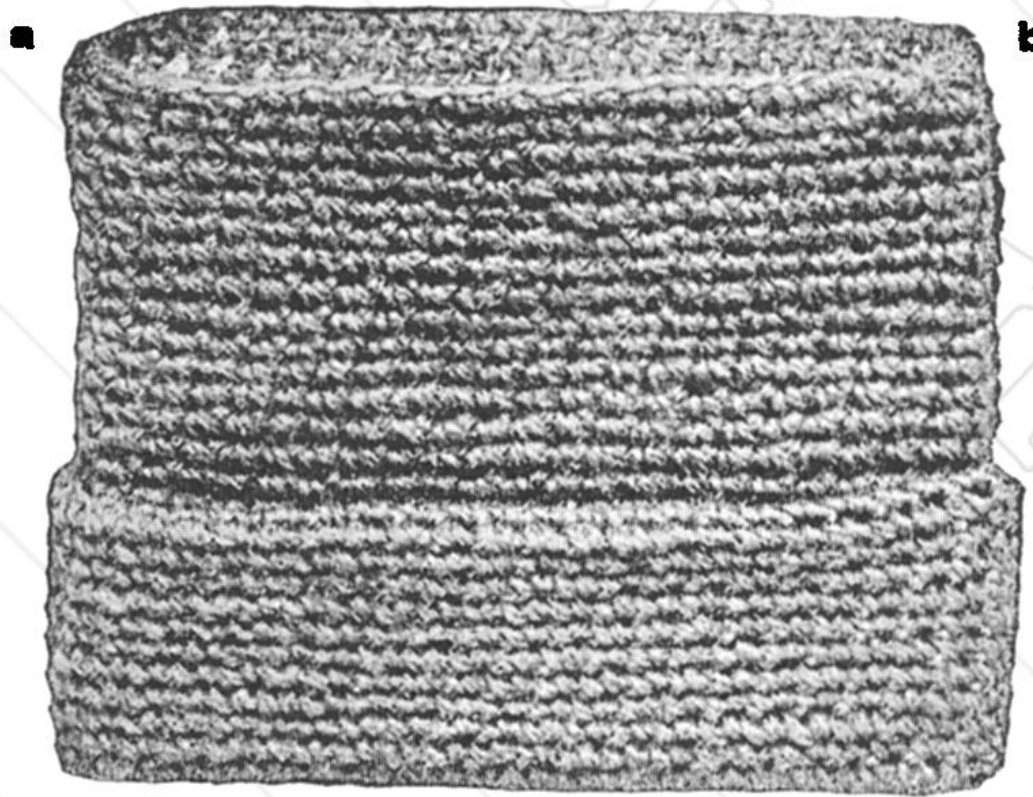

a

b

See
color plate
opposite
page 104

A

DOLL'S CROCHETED TOQUE OR CAP

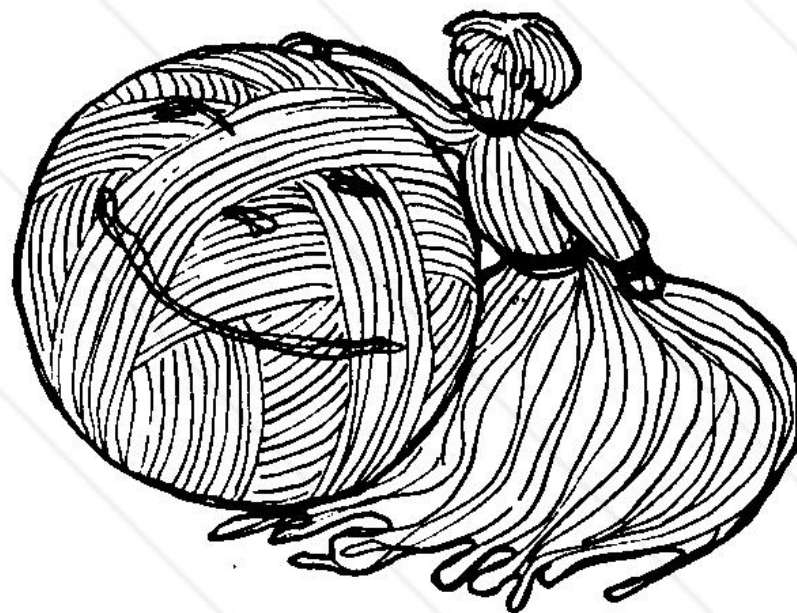

"Oh my! Oh my!"

3. Make 2 slip stitches. Then turn, and work on the wrong side.

4. Make 50 single crochets for 25 rows. Fasten the end of the floss.

5. Thread a zephyr needle or a darning needle with the floss. Lay the chain-stitched edge together like the top of a stocking laid flat, and sew or overhand it together from a to b to form top of cap. (See figure A on page 94).

6. Fold up on outside of cap, about 12 rows of the single crochet stitches last made. Fold up about 13 more rows. This roll forms the part around the head of the doll.

7. Bring points *a* and *b* down to meet the roll, and pin in place. Fasten points in place by sewing on pom-poms for trimming.

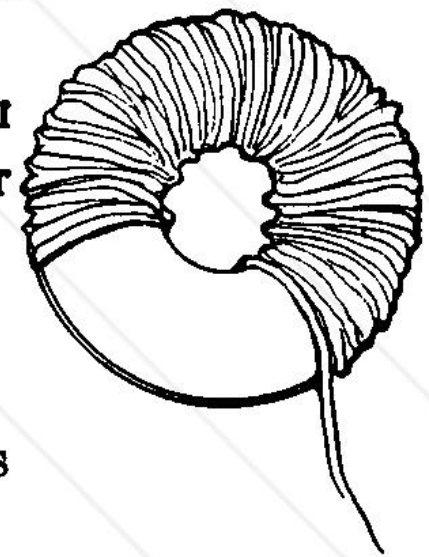

To Make Pompons

1. Cut 2 cardboard circles, making them measure 3 inches across.

2. Cut out a circular hole in the center of each, making it $\frac{1}{2}$ inch across.

3. Cut off 1 piece of old rose and 1 piece of gray floss, making each about 3 yards long. Put the ends together, side by side.

4. Holding the 2 cardboard circles together, thread the gray and rose floss into the center hole, over the edges, into the center, over the edges, doing this over and over again until the entire length of floss is used.

5. Put one leg of a pair of scissors between the 2 cardboard edges of the circles, and cut the floss apart

Wind with floss.

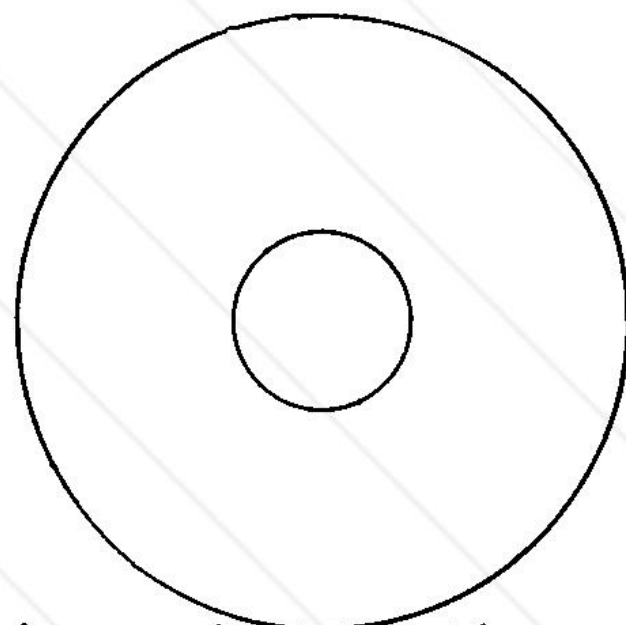

Make of cardboard.

6. Put a short double thread of floss between the 2 cardboard circles and tie the ends of the double thread firmly together.

7. Tear off the cardboard, and carefully clip the surface of the pompon even.

“Now, may I show you how Mary Marie looks in her cap and scarf?” asked Mary Frances, finishing off the pretty little toque in a short time.

“Indeed you may!” Fairly Flew replied, and Mary Frances ran to get her.

Soon she had the proud dolly dressed, and held her up for all to see.



“Indeed
you may.”

“Wintry weather,
Blowsy gale,
Will never turn
Your dolly pale.

She will go out
Without a care,
Because her scarf
And cap she'll wear,”

sang Crow Shay.

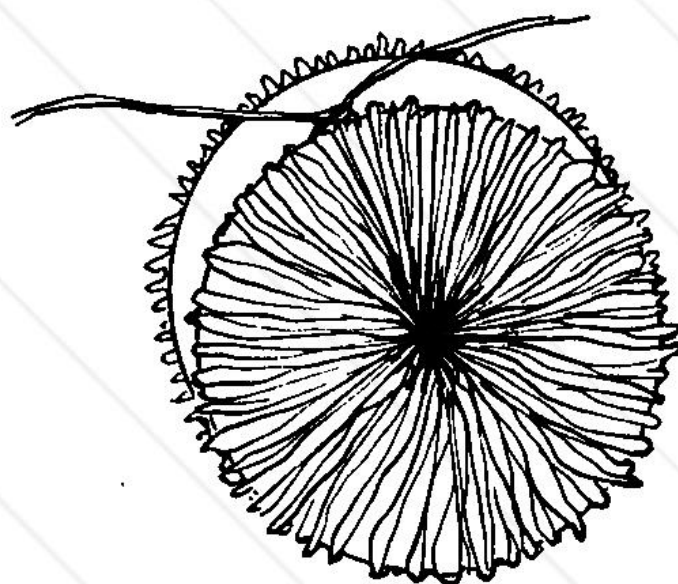

Tie between two cardboards.

"She is to have another cap or a hat to match the first scarf that you made," said the Yarn Baby. "She can wear that set to school—does Mary Marie go to school?" she asked.

"Oh, yes," said Mary Frances; "to kindergarten."

"Then we must hasten to get the little hat made!" Fairly Flew exclaimed.



"Does she
go to school?"



"Oh yes, to kindergarten."



"I'll give directions."



PLEASE let us hear the new directions,
"Yarn Baby," Fairly Flew said.
And then the Yarn Baby began:

DOLL'S CROCHETED TURBAN (HAT)

(See the picture opposite page 40—color plate)

Material: Old rose or blue four-fold Germantown zephyr.
Gray Germantown zephyr for trimming.
Bone crochet hook No. 5.

Directions:

To Make the Top of the Crown of the Hat

1. With rose or blue yarn make 5 chain stitches.
2. Join the chain in a ring with slip stitch.
3. Make 1 chain stitch.

[99]

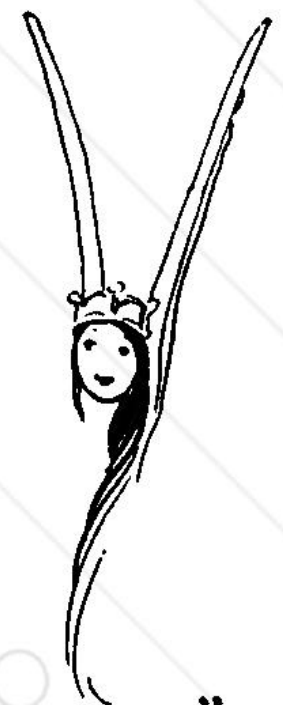

"Please."



Yarn Baby began.



DOLL'S CROCHETED TURBAN (HAT)

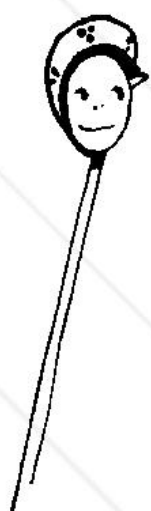
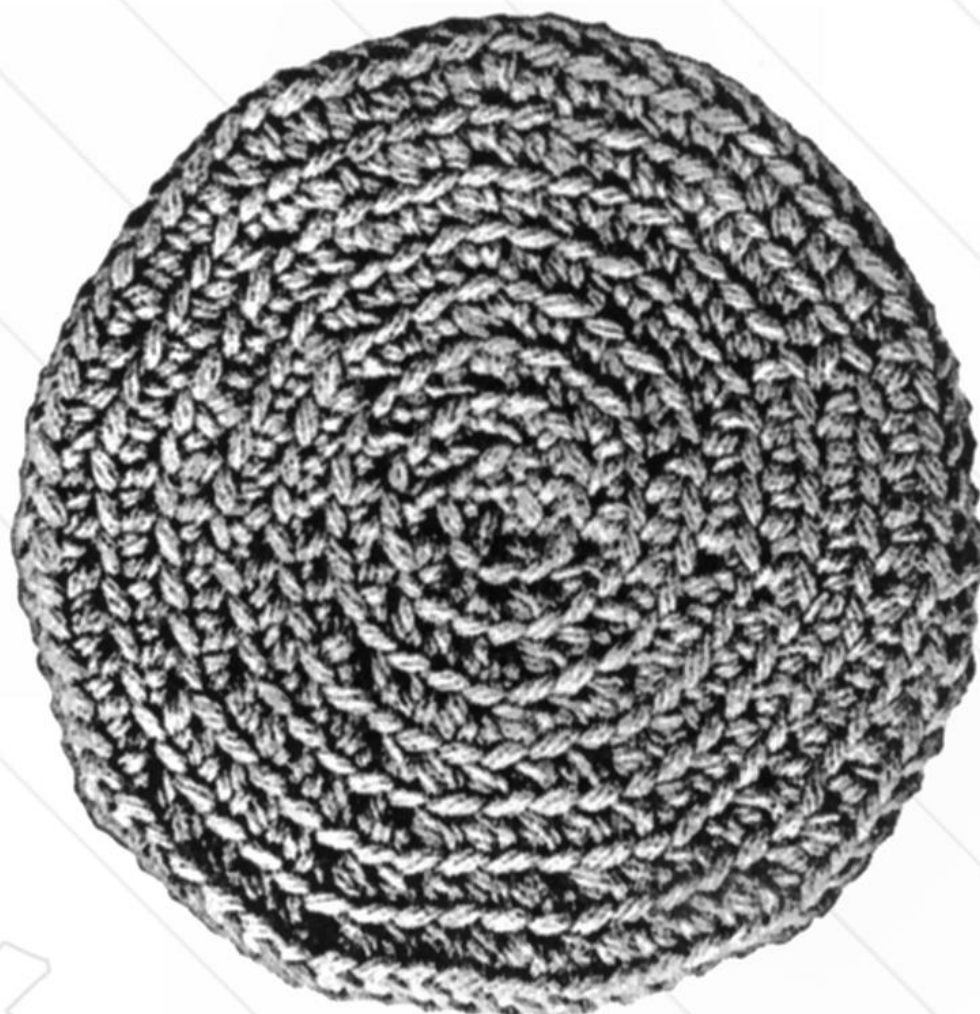

"Use me."

4. Put 2 single crochet stitches in each chain stitch in the ring (10 single crochet stitches in all). Tie a piece of sewing cotton in the last stitch to mark end of row. (See picture A, page 101.)

NOTE.—In making the turban, put the crochet hook through back loop only of the stitches already made. (See picture A, page 101.)

5. Second row: Put 2 single crochets in each stitch.

6. Third row: Put 1 single crochet in each of the first 2 stitches. Put 2 single crochets in third stitch.

NOTE.—When 2 or more stitches are put into 1 stitch in this way, it makes the work fuller or larger. This is called "increasing."

Put 1 single crochet in each of the next 2 stitches. Put 2 single



Germantown zephyr.

MARY MARIE'S TURBAN

101

crochets in next stitch. Continue in this way until end of this row.

7. Fourth row: Same as third row.

8. Fifth row: Increase, by putting 2 single crochets in every fifth stitch, and continue in this way until there are 8 full rows.

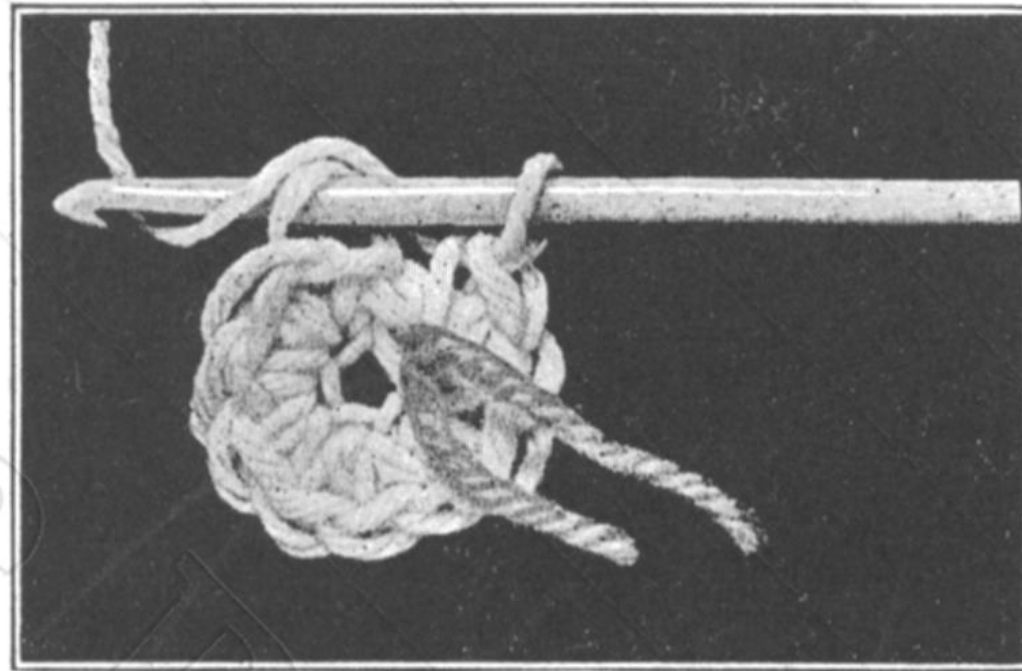

A

To Make the Side of Crown, or the Band

1. Make 58 chain stitches. Join in a ring with slip stitch.
2. Make 1 single crochet in each stitch of the chain.
3. Second row: Put 1 single crochet in each single crochet, taking up back loop only. Continue doing this until there are 6 full rows.

The turned-up band of gray is made in the same way as the band just finished.

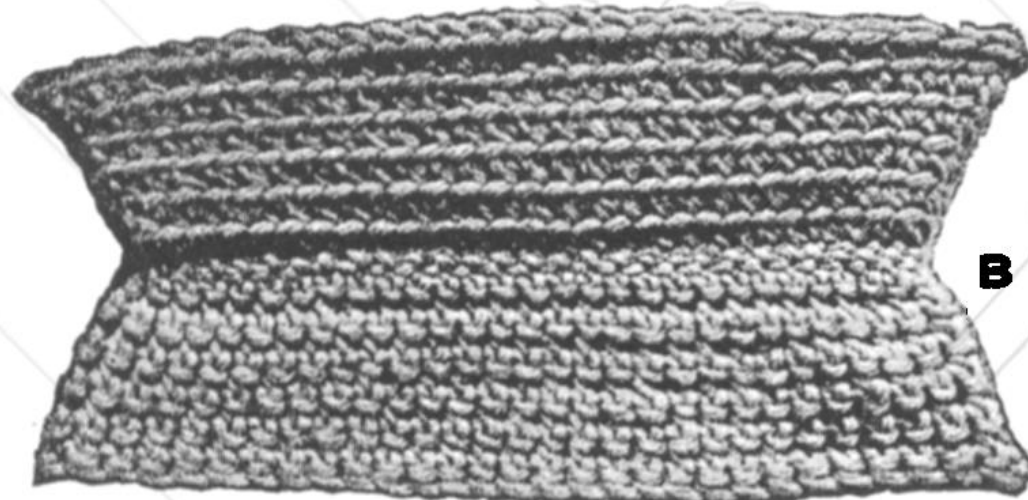

B

To increase

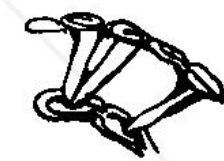

To Put Turban Together

1. Hold the right side of the crown toward you. Hold the top edge of the rose

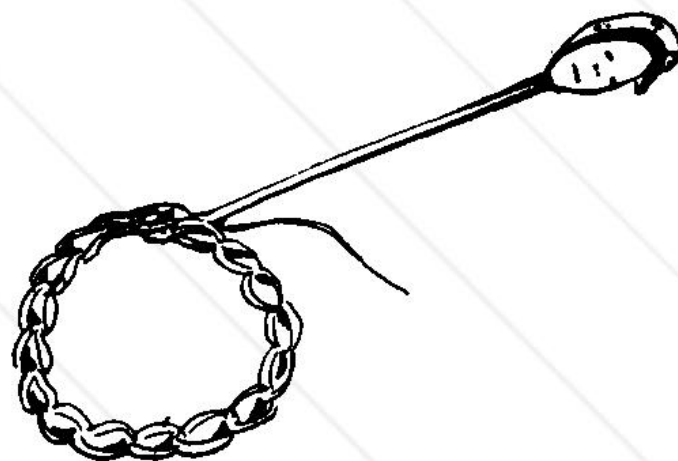

Join in a ring.

102 KNITTING AND CROCHETING BOOK

or blue band (not the chain-stitched edge) to the edge of the crown. Baste edges together. Catch edges of crown and band together with single crochet stitches.

2. Place gray band inside of the rose or blue band, with the right side against the inside (or wrong side) of the rose or blue band. Thread a zephyr needle or a darning needle with gray yarn, and sew the edges neatly together. (Picture B on page 101 shows the two bands spread open after they have been sewed together.)

3. Turn the gray band up on the outside of turban and sew a rosette on the left side of the crown and on the turned-up band.

To Make Rosette

Lay the ends of the two colors of zephyr together side by side. With a large crochet hook (about No. 8) make 45 chain stitches. Break off yarns and fasten ends.

Form the chain into 6 flat loops and sew on left side of turban, using gray yarn in a zephyr or darning needle.

As soon as it was finished, Mary Frances put the turban on Mary Marie. Then she put the scarf which matched it around the dolly's neck.

"Doesn't she look sweet!" she exclaimed. "I'll let you all kiss her."

"Oh, excuse—!" began Crow Shay, but he never finished the sentence, for there came a voice at the door. It was Katie's voice.

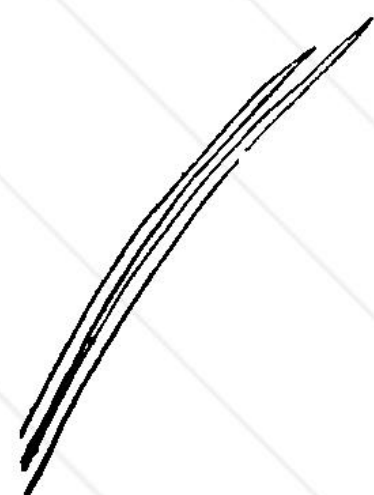

To make
rosette.



"Doesn't she look sweet!"

"Miss Mary Frances! You haven't been out at all to-day!" she said. "Your mother wouldn't like that."

Mary Frances ran to the door. "Why, Katie, that's so! I must go out. I'll get ready right away. I've been doing some crocheting."

"That's fine," Katie said. "I wish I knew how to crochet."

"Maybe I can teach you some time after I learn more myself," said Mary Frances.

"I should love to learn." Katie looked pleased. "Well, I must be about my work now," she added, and went downstairs again.

When Mary Frances turned back to the sewing table nothing was to be seen but the empty rocking-chair and the knitting bag.

"Oh, dear," she thought, "where can everybody be?"

She lifted the bag. Underneath was Mary Marie just as she had dressed her.

She put her hand into the bag and found Wooley Ball and the Yarn Baby, but could not find Crow Shay.

"What is the little rascal hiding for?" she wondered.



"I should love to."

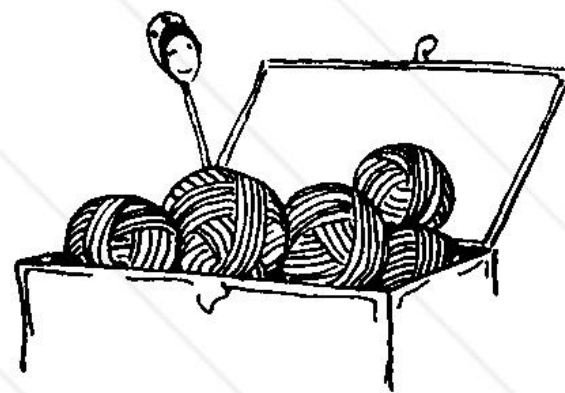

Out popped Crow Shay.

"Look in the chest of yarns," said Wooley Ball.
Mary Frances opened the lid. Out popped Crow
Shay's little round head.

"So scared was I,
I thought I'd die;
So ran and hid—
That's why! That's why!"

he sang.

"And Fairly Flew," asked Mary Frances; "where
is she?"

"She's gone! She's gone!
Been gone before;
But she'll come back
Some more, some more,"

"So scared
was I."

promised Crow Shay, and the little girl went happily
out to play.

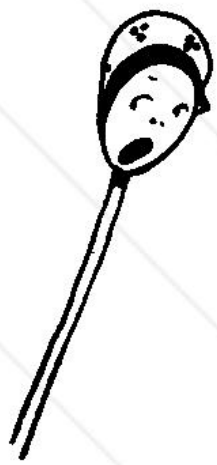

"Where is she?"



GOING SHOPPING

FOR DIRECTIONS FOR MAKING KNITTED ARTICLES SHOWN IN THIS ILLUSTRATION SEE
SHOPPING BAG—242 CROCHETED HAND BAG—248 CROCHETED PURSE—255
CROCHETED WOOL FLOSS SCARF—84 CROCHETED TOQUE OR CAP—93

Antique Pattern Library

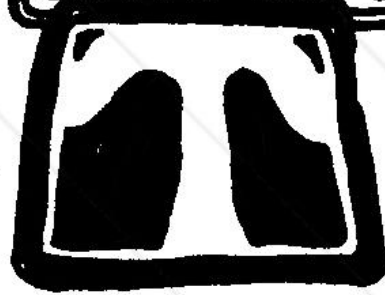

HE next morning, after breakfast, Mary Frances hurried to her room, hoping to have another delightful lesson.

"Aunt Maria will be so surprised to see what I've done," she whispered. "And mother will be so pleased."

"You surely will surprise them," said the Yarn Baby, "and if I am not mistaken we will have to work with all our might to get everything ready by the time they come home."

"Indeed we will!" said Mary Frances, getting things ready for work. "I wonder what comes next?"

"Oh, excuse me," she exclaimed after a moment,



"Indeed we will!"



"You surely will surprise them."

"I must go get my dolly. I put her to bed in the play-room last night."

When she lifted Mary Marie out of her little bed and stood her on the floor, the little thing looked at her and said, "Mamma, my tootsies are told."

"Oh, can you talk again?" cried Mary Frances. "Is it true, or am I dreaming?"

"'Torse it's true," answered Mary Marie. "'Torse it's true. Fairly Flew tame in the night and tised me."

"What did she tell you, dear?" asked Mary Frances, lifting the doll in her arms.

"She said that I tould talk until the lessons were over."

"Oh, I hope that they last as long as I live!" said Mary Frances, hugging the doll close.

"Toe do I!" Mary Marie said. "But my foots are told."

"Oh, you darling!" cried Mary Frances. "You want me to make you a pair of slippers!"

"Please, Mamma," said the little doll.

So Mary Frances dressed her in her bathrobe, and carried her into the sewing room and sat her on the table.



"Can you talk?"



"My tootsies are told."

“How I wish I had a little ball for her to play with,” she said.

Then the Yarn Baby asked, “Why not make her one? I’ll give you the directions:

BABY’S BALL

(See picture opposite page 136—color plate)

Make the same way as the pompons on the Doll’s Toque (page 95), using circles 3 inches across with a 1-inch opening in the center. Wind until center is almost filled.

“Never throw away ends of yarn,” Wooley Ball added. “You can make them into a beautiful baby’s ball—no matter how many different colors there are; or you can make a ball for your mother to use as a—

HAIR PIN BALL*

(See picture opposite page 40—color plate)

Make in same way as pompons on Doll’s Toque, using circles of cardboard $3\frac{1}{2}$ inches across, and a 1-inch opening in the center. Wind until opening is almost filled.

“Oh, I will give mother one on her birthday!” said Mary Frances.

Soon she set to work and made a baby’s ball for Mary Marie.

* For small hair pins.



Baby’s
ball.



“I’ll give directions.

"Pretty ball!" said the dolly, trying to catch it in her hands again and again. Suddenly she began to cry.

"Why, what is the matter, dear?" asked Mary Frances.

"Foots told," the baby sobbed.

Mary Frances laid the dolly's shawl over her feet. "Is that better?" she asked. "Oh, how I wish I knew how to make you a pair of slippers!"

"You will soon learn how to do that," said the Yarn Baby, and gave the directions for making—

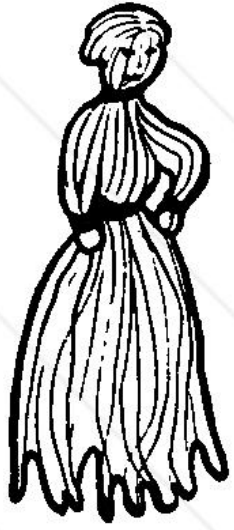

"You will soon learn"

DOLL'S CROCHETED BEDROOM SLIPPERS
(See picture opposite page 200)



Material: Pink or light blue German-town zephyr. Bone crochet hook No. 3.

Directions:

The work is begun at the toe of the slipper. See "A" in the picture on page 109.



"Foots told," the baby sobbed.

1. Make 8 chain stitches.
2. Skip 1 chain, and put 1 single crochet in each of 3 chain stitches.
3. Put 3 single crochets in the fourth chain stitch.
4. Put 1 single crochet in the next 3 chain stitches. Make 1 chain to use in turning. (In single crochet work, always make 1 chain in turning.)

5. Second row: Put 1 single crochet in each stitch, taking the back thread only of the stitch. (The first and second rows form a "rib." The slippers are made of "ribs.")

6. Third row: Put 1 single crochet in each of 4 stitches. Put 3 single crochets in the fifth stitch. Put 1 single crochet in each of the next 4 stitches.

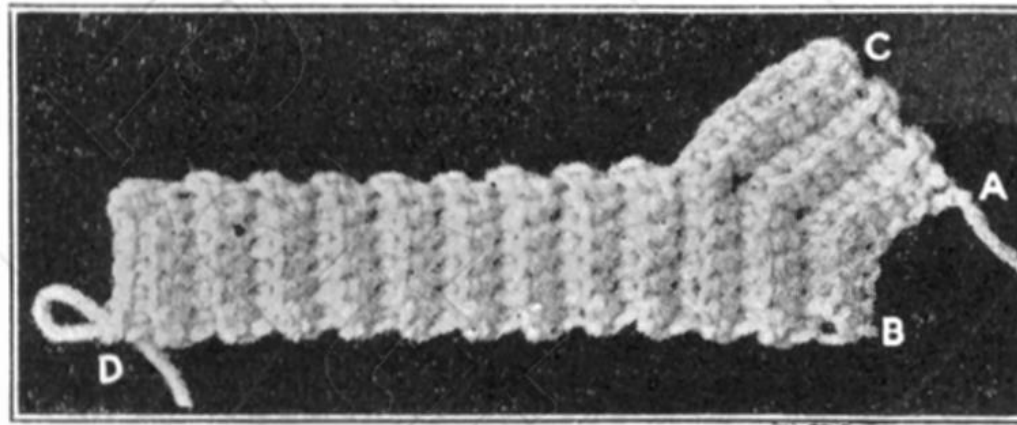

NOTE.—The adding of stitches, as in the fifth stitch, is called "increasing."

7. Fourth row: Put 1 single crochet in each stitch.
8. Fifth row: Increase as in direction No. 6 in sixth stitch.

Single
crochet.

9. Sixth row: 1 single crochet in each stitch. This row completes the toe part, or front of the slipper.
10. Seventh row: This row starts the sides. Make 1 single crochet in each of 6 stitches. Make 1 chain to turn.



To join slipper.

11. Eighth row: Make 1 single crochet in each stitch. Make 9 ribs for the sides of the slipper.

To Join Side to Toe

Hold the edge of the ninth rib (D) to edge of opposite side of front (C), right sides facing each other. (See picture page 109.)

Join edges with single crochet stitches, taking up 1 loop only of the stitches forming the ribs.

To Form the Toe

Fold tip of toe together, bringing A to B. (See page 109.)

Thread a darning or zephyr needle with yarn and sew tip of slipper toe together.

To Make Top of Slipper

Spaces for runners are made in this way: Starting* at corner at right side of top (A), make 2 chain stitches. Join them with a slip stitch to the point at the top of the nearest rib.

Continue in this way all around top of slipper.

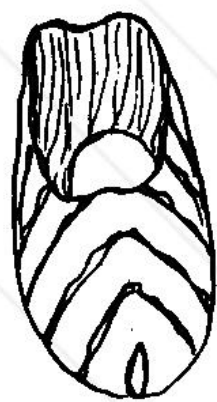

Fold tip of toe.

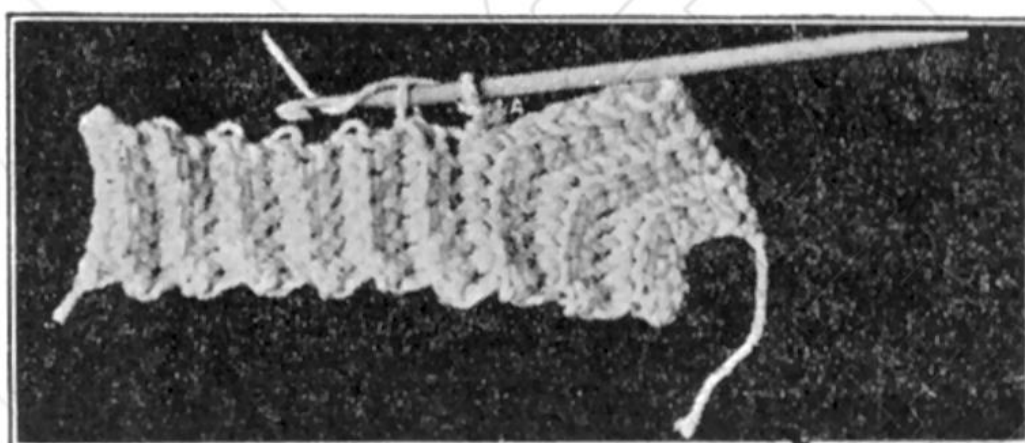

To Make Trimming at Top

Make 3 chain stitches. Put crochet hook through the first runner space and make a slip stitch. Make 3 chains and

*See how to attach new yarn, page 142.

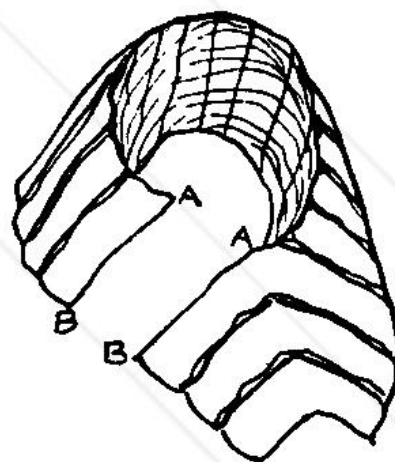

Join at A and B

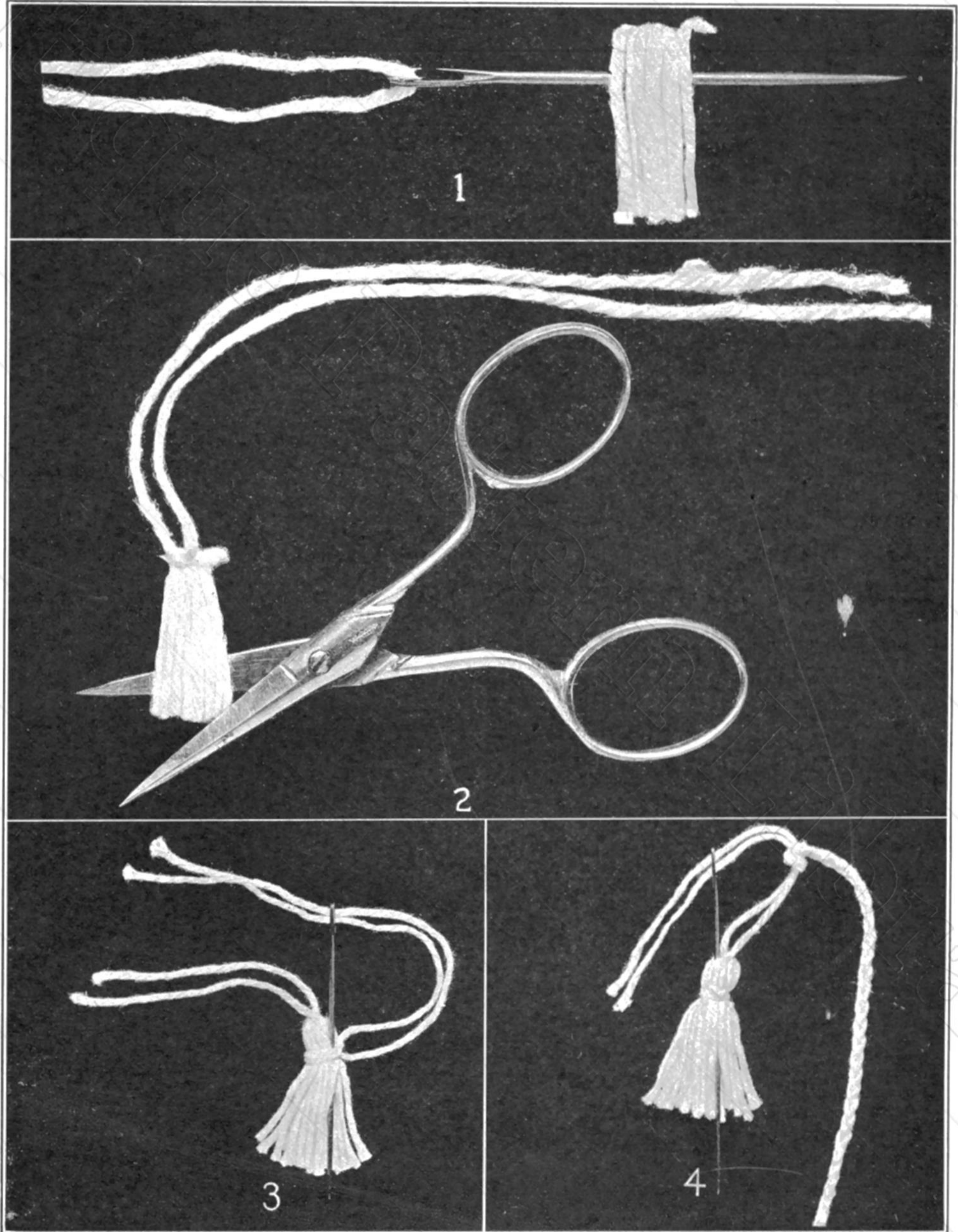

PLATE 3—STEPS IN TASSEL MAKING
SEE DESCRIPTION, PAGE 111

Antique Pattern Library

put a slip stitch in the next runner space. Continue all around top of slipper.

To Make Runner.

Make a chain of 45 chain stitches.

Thread this into the runner spaces just as in making doll's petticoat (see page 90), and put tassels on the ends.

To Make Tassels

(See pictures on opposite page)

1. Cut a piece of cardboard 1 inch long and $\frac{1}{2}$ inch wide.
2. Over this, wind a strand of yarn 10 times.
3. Thread a long-eyed zephyr needle with yarn. Slip it under the yarn on the cardboard and tie it together at the top.
4. Clip the yarn apart at the other edge of the card.

Hold the clipped ends between the thumb and fingers of the left hand, and tie the tassel with a piece of yarn, to look like picture No. 3.

Thread the ends of the tie-string into a long-eyed needle. Pull the ends down through the middle of the tassel and cut them off even with the bottom.

Thread a zephyr needle with both ends of yarn at top of tassel and pull needle through one end of the runner.

Fasten the ends by pulling needle through tassel from the top. Cut off ends even with tassel fringe. (See picture No. 4.)



Thread this into runner.

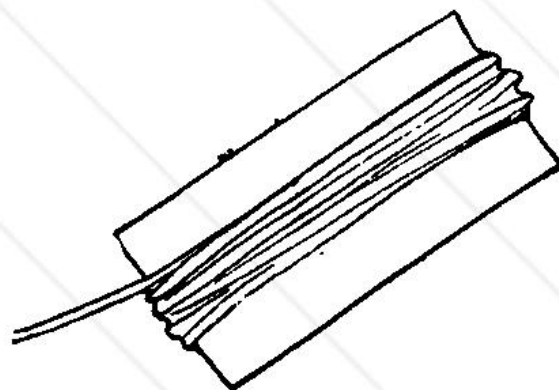

To make tassels.

To Make Slipper Soles

Lay doll's shoe on a piece of light-weight cardboard and mark it with a pencil; cut it out. Or trace the outline below, and use it as a pattern.

Thread zephyr needle with yarn, and sew slipper to sole.

When the Yarn Baby had finished giving the long directions for the slippers, Crow Shay, who had been very quiet, could not keep still another second.

"Whew! Yarn Baby!" he broke in. "Whew! How do you know so much? You certainly are a woolly-headed know-it-all!"

At first the Yarn Baby did not know what to say to this impudent speech. Then her hair stood up stiff and straight.

"If I'm—if I'm a woolly-head," she cried, "you're an old bone-head! So you are! So there!"

Crow Shay grew pale, stood up on end and started for the Yarn Baby, when Wooley Ball just rolled in his way and Crow Shay pitched over her, head first.

"Mind your manners, Crow Shay! Mind your manners!" said Wooley Ball calmly.

All the Knitting People laughed merrily at Crow Shay's silly caper, except poor Crow Shay, who looked a little ashamed of himself

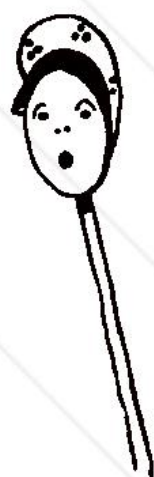

"Whew!
Yarn Baby!"

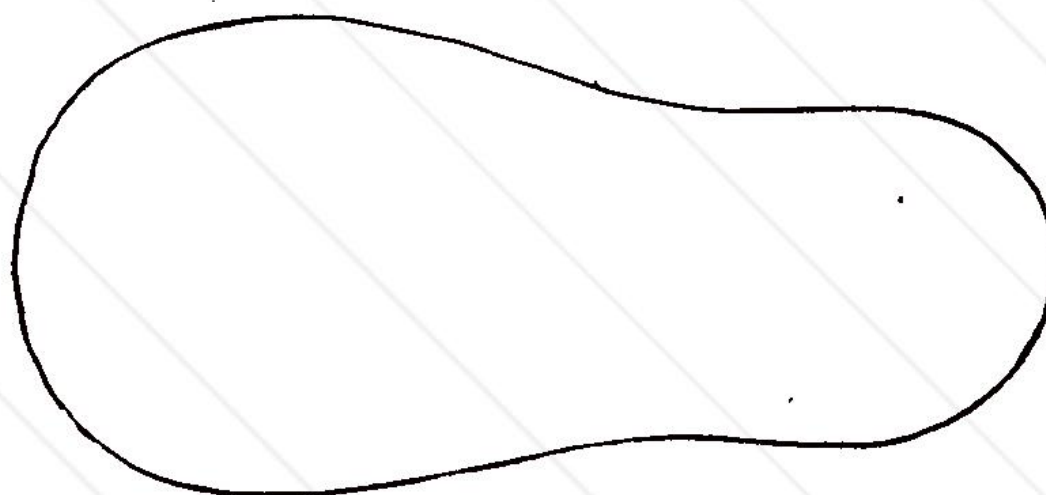

Trace this pattern.

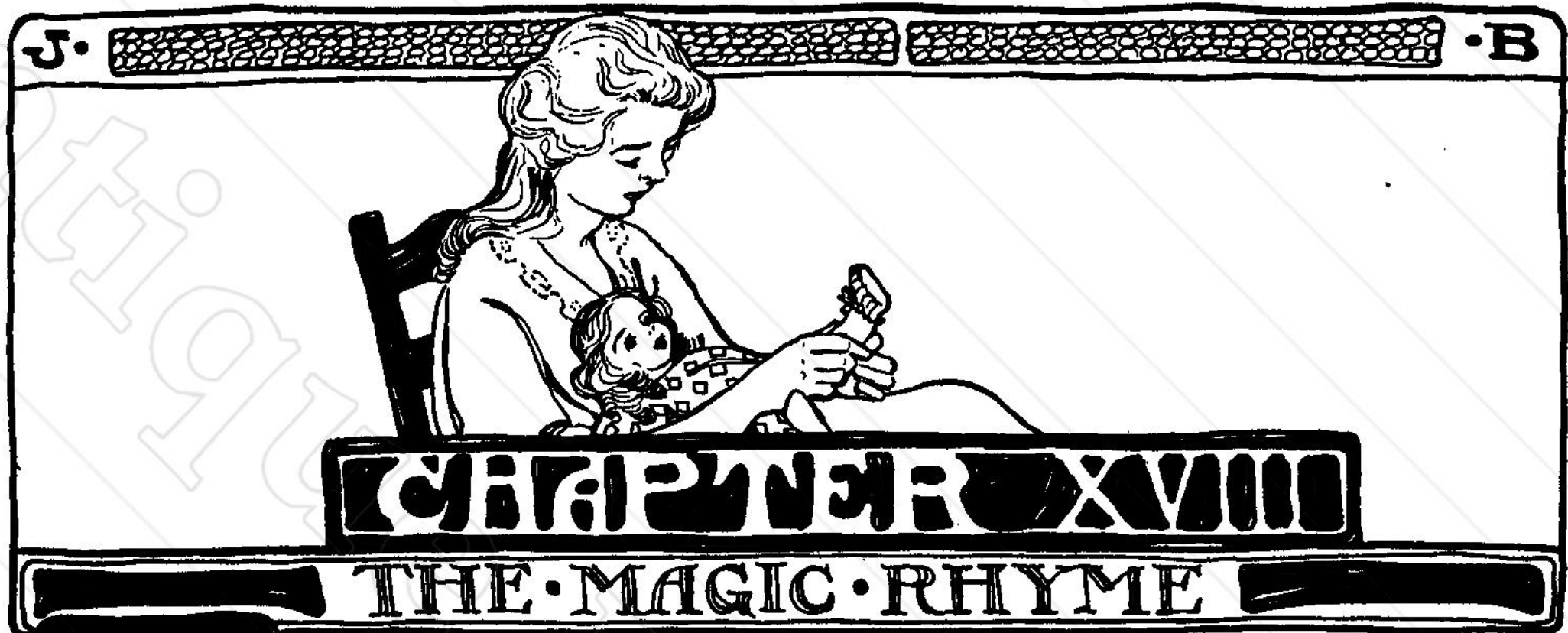

M

ARY FRANCES, who wanted to laugh, too, pretended not to notice, and picked up a ball of pink yarn.

“If only I had Fairly Flew’s magic needle!” she said, “I could get the slippers finished very soon for my poor baby’s cold feet.”

She started to pick up Crow Shay.

“Wait a moment! Wait a moment!” exclaimed the little fellow who was himself again. “Don’t you want to call the fairy teacher?”

“If I only knew how to, I certainly should call her, Crow Shay,” replied Mary Frances. “You help me a good deal, but——”

“Oh, I know!” said Crow Shay. “I can’t do what

[113]

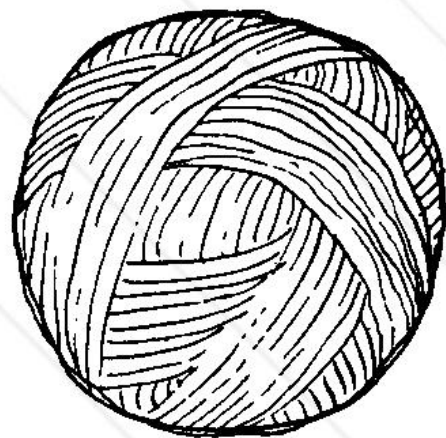

A ball of pink yarn.

Fairly Flew can do for you, but I can do this much; I can tell you how to summon her."

"Will you please tell me?" begged Mary Frances.

"Indeed he will," spoke up the Yarn Baby, who forgave very quickly. "We all love you because you are so anxious to learn our lessons. Begin, Crow Shay."

"All right," said Crow Shay. "When you want the fairy Fairly Flew during our lessons, just whisper this little rhyme:

" 'Fairy Fairly Flew,
Please come, for I need you.' "

"That's easy!" cried Mary Frances, repeating the rhyme:

"Fairy Fairly Flew,
Please come, for I need you."

She had scarcely finished speaking when there came the light rustle of wings; and a tiny voice of silvery sweetness said, "Here I am, little girl. I always come to help those who try to learn their



"Indeed
he will."



"Here I am, little girl."

lessons. They may not always see me, but I put magic into their needles after they practice what they learn. They may not be able to work quite as quickly as you do when I am with you, but they can work pretty fast—so fast that people may say that the needles fairly flew.”

“How glad I am that you help other little girls, too,” said Mary Frances, taking the magic needle which the fairy held out. “Thank you for coming to me, dear Fairly Flew!”

Then she started to make the slippers—and you know how quickly they were finished.

“Aren’t they beautiful?” cried Mary Frances. “Now my dolly’s feet will keep warm.” And she put them on Mary Marie’s little feet.

“Footies nice and warm,” gurgled Mary Marie; “footies hidin’ away from Jack Frost,” and went on playing with her ball.



“Aren’t they beautiful?”



“Footies nice and warm.”



“Won’t that be splendid”

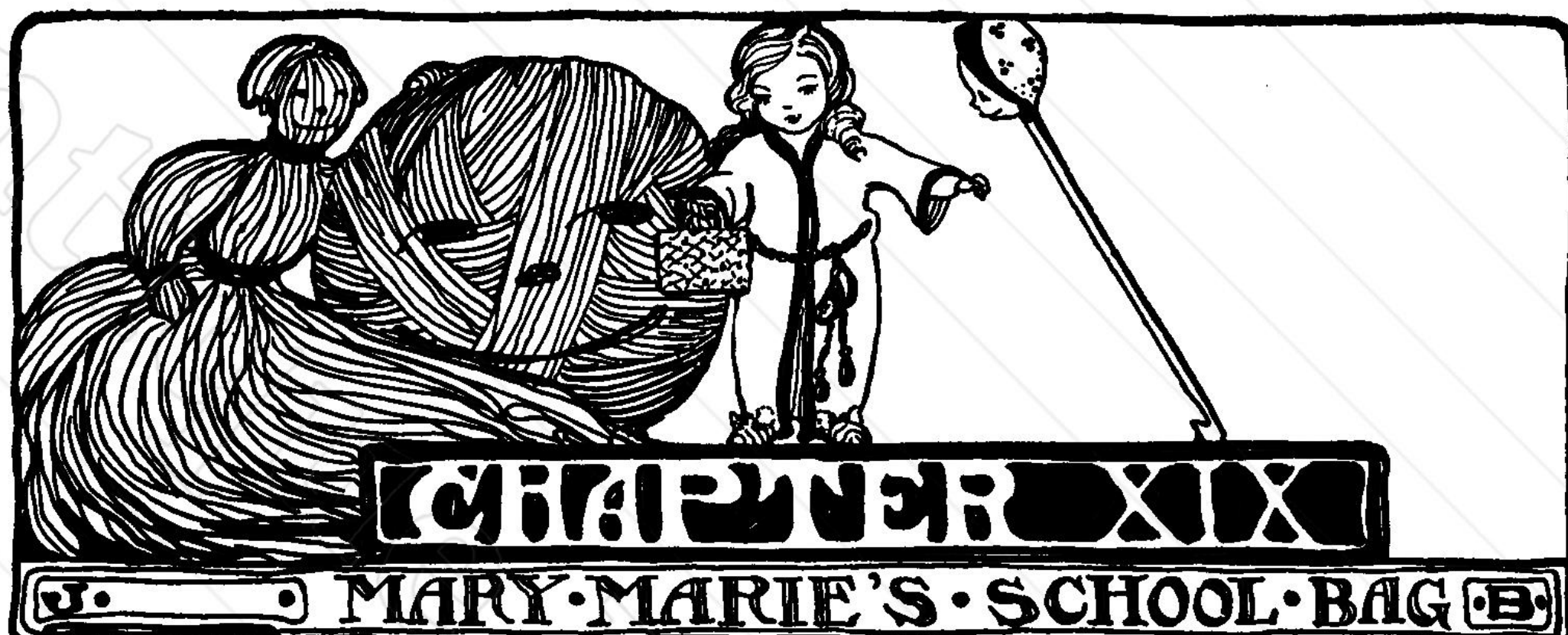

AFTER everybody had admired the little slippers, the Yarn Baby said, "If Mary Marie goes to kindergarten, she should have a little school-bag to carry her pictures and books in, I think."

"Wouldn't that be splendid!" cried Mary Frances. "What kind of yarn shall I use?"

"Let me look into the box," replied Wooley Ball, rolling over to the end of the sewing table and peeping over the edge of the chest, "Oh, there is the very thing to use—ecru crochet cotton. Cotton will wear much better than wool for a bag." As Mary Frances picked up the ball, the Yarn Baby began to give the directions for making—



Has she a school-bag?

[117]

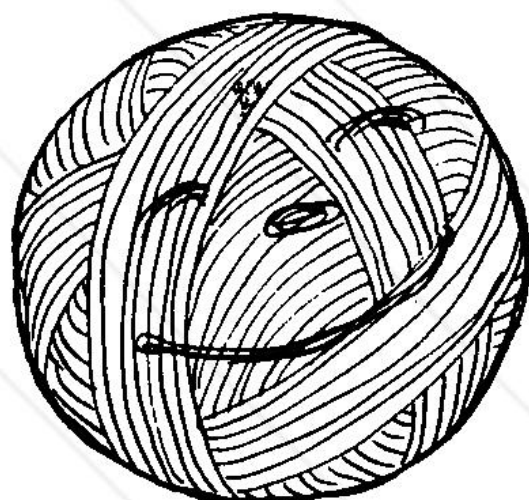

"Let me look into the box."

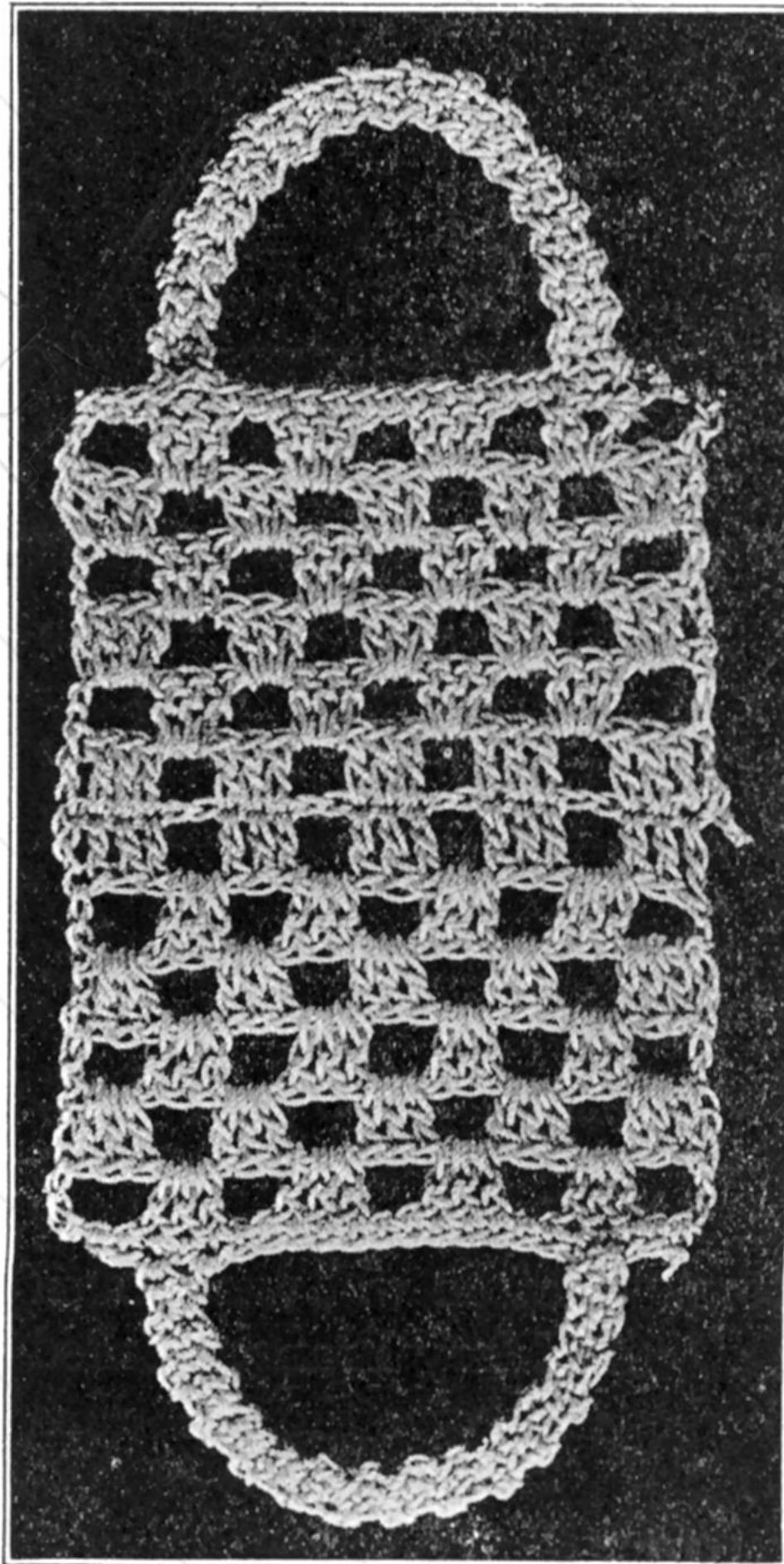

**DOLL'S CROCHETED
BOOK BAG**

(See color plate page 40)

Material: Ecreu cro-
chet cotton (mercerized).

Steel hook No. 7.

Directions:*

1. Make 26 chain
stitches.

2. Put 1 double cro-
chet stitch into the fourth
chain stitch from the
needle.

3. Put 1 double cro-
chet into the fifth chain
stitch.

4. Put 1 double cro-
chet stitch into the sixth
chain.

5. Make 2 chain
stitches.

6. Skip 2 chain
stitches in the first row,
and put 1 double crochet
into the next chain stitch;
that is, into the third



Dolly's
books.

*This work is begun in the middle of the bag—see the knot on the right-hand edge in the picture.



Dolly at school.

chain stitch from the last double crochet stitch which you made.

7. Put a double crochet in each of the next 2 chain stitches.

8. Repeat directions No. 5, 6, and 7 to end of chain.

9. Make 5 chain stitches to use in turning.

10. Put 3 double crochet stitches into the first space of the row just made.

11. Make 2 chain stitches.

12. Continue making clusters of 3 double crochets in each space with 2 chains between—to end of row. The last stitch in the row will be 1 double crochet taken into the top of the 3 chain stitches which were used in turning the row below.

13. Continue making rows like these two until there are 6 rows. This makes one side of the bag.

14. Taking up the threads on the other side of the first row of chain stitches which you made, make other side of bag like first side. (See picture below.)

15. Fold the two sides of bag together, along the row of chain stitches first made, and fasten them together with single crochet stitches along the edge, catching each side.

16. Make 1 row of single crochet all around the top of the bag.

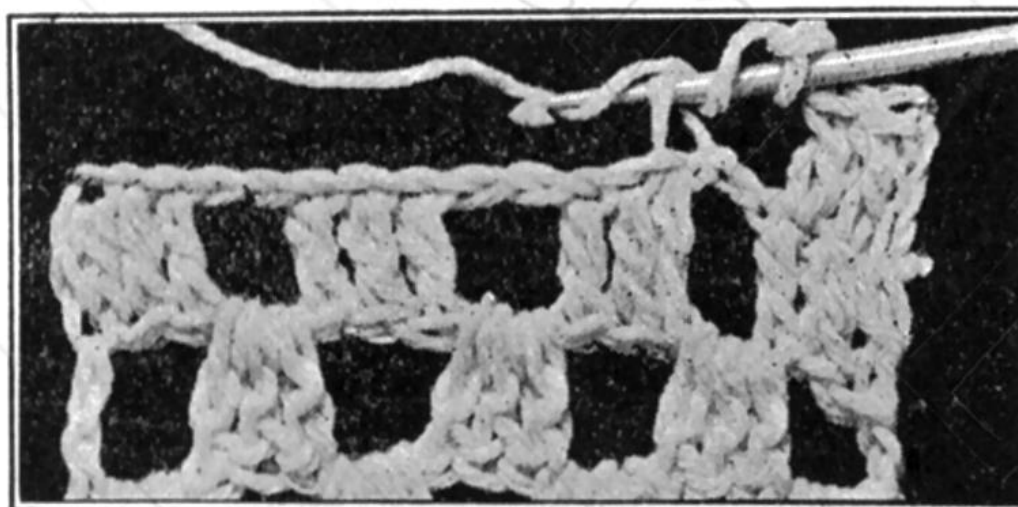

Book bag.

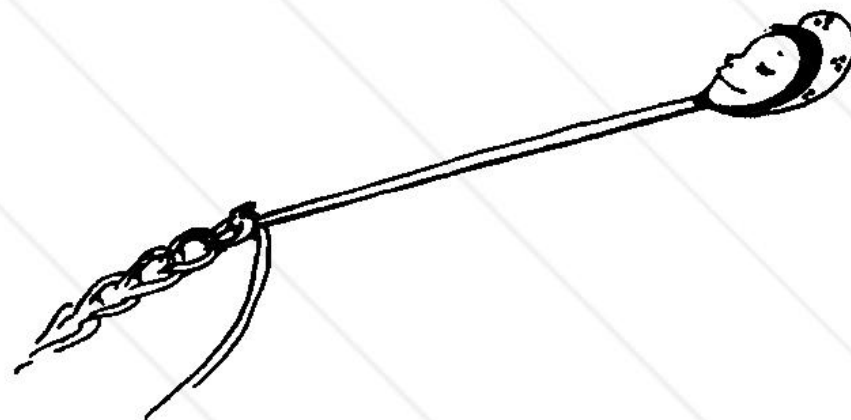

Make 5 chain stitches.

To Make the Handle

1. At the top of the first cluster of double crochet stitches from the side, make 2 single crochet stitches. (See picture, page 118.)
 2. Make 1 chain stitch to use in turning.
 3. Make 2 single crochet stitches.
 4. Continue directions Nos. 1 and 2 until handle is $2\frac{1}{2}$ inches long. Fasten the end of handle into the top of the first cluster of double crochet stitches from the other side of the bag, using slip stitch.
 5. Make another handle on opposite side of bag in same way.
- NOTE.—In fastening ends of threads, be sure to pull the last stitch very tight before cutting off the ends.



Make
handle.

When Mary Frances had finished making the little bag, she hung it on the dolly's arm.

"Doe to tool! Doe to tool, now!" cried Mary Marie.

"Not in your bathrobe and slippers, darling!"

"Den what s'all I do?" asked Mary Marie. "I'se tired of ball! Wish I had a dolly!"



Hung it on the dolly's arm.

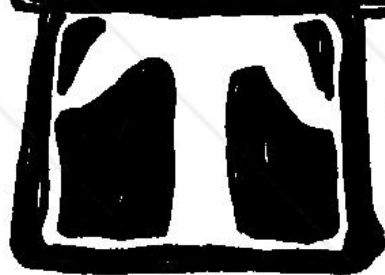

HE poor little dear!" exclaimed Fairly Flew, "a doll she shall have, and I will tell you how to make it myself—a doll that looks ever so much like Mary Frances' own dolly, our dear Yarn Baby!"

Then she told the little girl—

HOW TO MAKE AN INFANT YARN DOLL

Material: White knitting worsted.* A strand of coarse red embroidery cotton. Two blue beads for eyes. (See picture, page 122.)

Directions:

1. Cut about 20 strands of yarn, each 8 inches long. Lay them together side by side.

2. Tie them together in the middle with a short piece of yarn. Fold them over in the middle where tied.

* Cotton string may be used in place of woolen yarn.

[121]



"Poor little dear!"

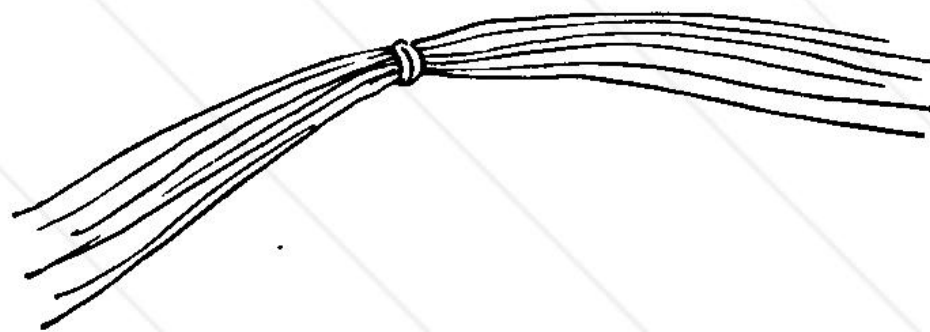

Tie in middle.

3. About $\frac{1}{2}$ inch below the fold, tie in the same way as you did the tassel on doll's slippers. (See picture No. 3 on Plate 3.) This forms the infant's head.

4. To make the arms, take hold of 4 strands of the yarn and tie a knot close to the neck. This forms the shoulder. About $\frac{1}{2}$ inch below the shoulder knot, trim off the 4 strands. Tie the 4 strands together with a short piece of yarn to form the hand.

5. Make the other arm opposite in the same way.

6. About $\frac{3}{4}$ of an inch below the neck, tie the long strands together to form infant's waist.

7. Sew two small blue beads in head for eyes, and take a stitch with red embroidery cotton to form the mouth.



To make
shoulder.



DINAH DOLL AND INFANT

"Baby! Baby!" cried Mary Marie as soon as Mary Frances had it finished.



"Baby! Baby!"

"How she loves that doll!" cried Crow Shay.
"She ought to have a nurse-maid to help her care for it."

"Indeed she ought to," declared the Yarn Baby.
"I would like to tell the little Miss how to make a Dinah Doll."

"Do tell her now," said Fairly Flew.
So the Yarn Baby began:

HOW TO MAKE A COLORED YARN DOLL

Material: Black knitting worsted.* White knitting worsted. A strand of coarse red embroidery cotton. Two white beads for eyes. (See page 122.)

Directions:

1. Cut about 50 strands of black worsted 12 inches long. Tie them together in the middle and fold.
2. Tie them again about $1\frac{1}{2}$ inches below the fold to form Dinah's head.
3. At each side of the body, close to the neck, take 8 strands and tie together in a knot to form shoulders and arms.
4. Trim off the strands about 2 inches below the knots, and tie with white yarn near ends—to form hands.
5. Cut 30 strands of white yarn about 8 inches long. Lay them together, side by side. Tie them together very loosely in

* Cotton string may be used instead of woolen yarn.



"Indeed she ought to."



"Do tell her now."

the middle, fold them in the middle, where tied. Tie the bundle of strands around doll's neck to form front of dress.

6. Follow direction No. 5 and tie in back of doll to form back of dress.

7. Cut a piece of black yarn about 8 inches long and tie it in a bow knot around the doll about $1\frac{1}{2}$ inches from the neck, to form the doll's waist.

8. At the bottom, with a short piece of white yarn, tie together about 6 strands of black yarn, to form a foot.

9. Make another foot in the same way.

10. Trim off the other strands of yarn at the bottom about $\frac{1}{2}$ inch above the feet.

11. Sew two white beads in place for eyes, and take two stitches with red embroidery cotton to form the mouth.

Sew infant doll in place in Dinah's arm.

To make the hair, cut 25 short strands of black worsted and sew with black thread to top of Dinah's head.

Trim hair with bow made of narrow red ribbon.



Eyelids
began to
droop.

When Mary Frances finished the funny colored doll, she sewed the white infant baby in the arm, to the delight of Mary Marie and the Knitting People.

Soon Mary Marie's eyelids began to droop; then Mary Frances carried her off to bed, and she went to sleep with the dolls in her arms.

"Oh, how I wish that I could tell mother about

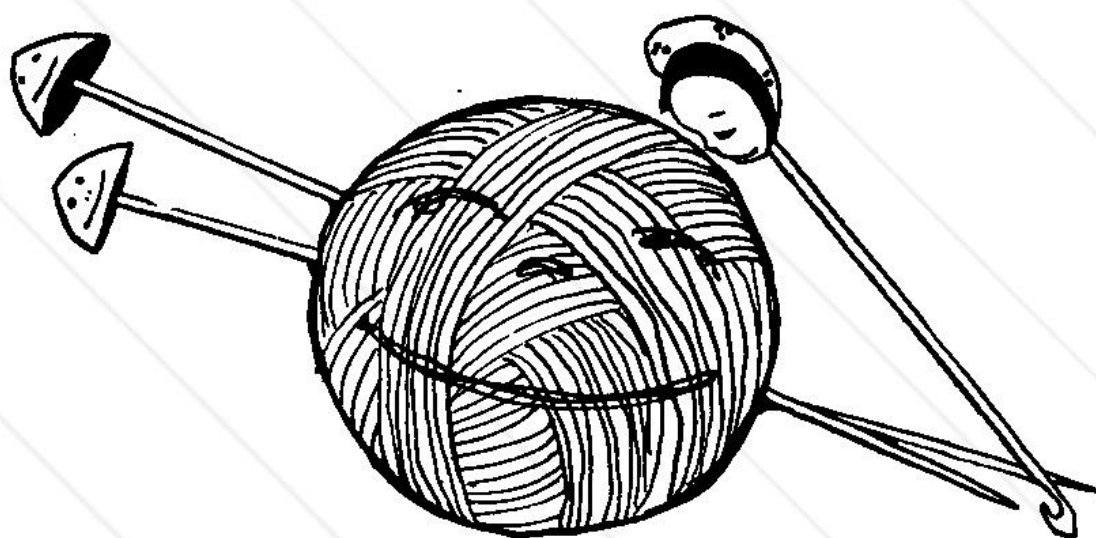

To the delight of the Crochet People,

my lovely times," thought Mary Frances. "Maybe when all my lessons are finished I shall be able to tell her. She would not worry about my being lonely if she knew how busy I am, and how happy now since I know that dear father is getting well."

Just then Billy called her and she hurried downstairs.

"Here is a letter from mother for you," said Billy, meeting her at the foot of the stairs. "Hurry and read it. I want to hear about father."

So Mary Frances opened it and read:

Dear Mary Frances:

You will be glad to hear that father is safe in the hospital and improving very rapidly. His leg was broken just above the ankle, and he is suffering from the shock of the accident. The doctors say that it will be a week or ten days, perhaps longer, before we can bring him home.

I am sending a newspaper which tells about the train wreck and explains how it happened.

You and Billy are in my thoughts every hour of the day and many times at night, too; but I am not worried because I know that Katie will take good care of you both.



Billy called her.



"Dear Mary Frances."

Father says that he is racing with time to get well enough to return home to you dear children, and that he will tell you the whole story when he arrives.

Aunt Maria sends love and says that she will teach you to crochet when she comes—and that you may practice the stitches which she has already taught you.

I shut my eyes and see you in my mind's eye, but I want to be able soon to see you really and truly.

Hugs and kisses from

Mother.



*"Oh,
Billy."*

"Good news!" exclaimed Billy as Mary Frances finished reading; "but it's no fun to have a broken leg."

"Oh, Billy, think how much worse it might have been," cried Mary Frances. "Won't we be glad to see father and mother back—and Aunt Maria?" and she caught him by the arm and waltzed him around the big hall.



"Good news!"

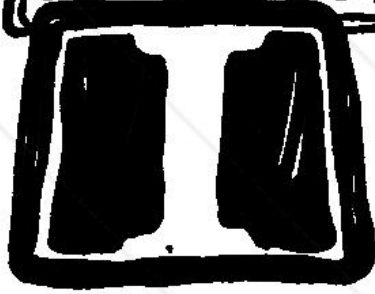
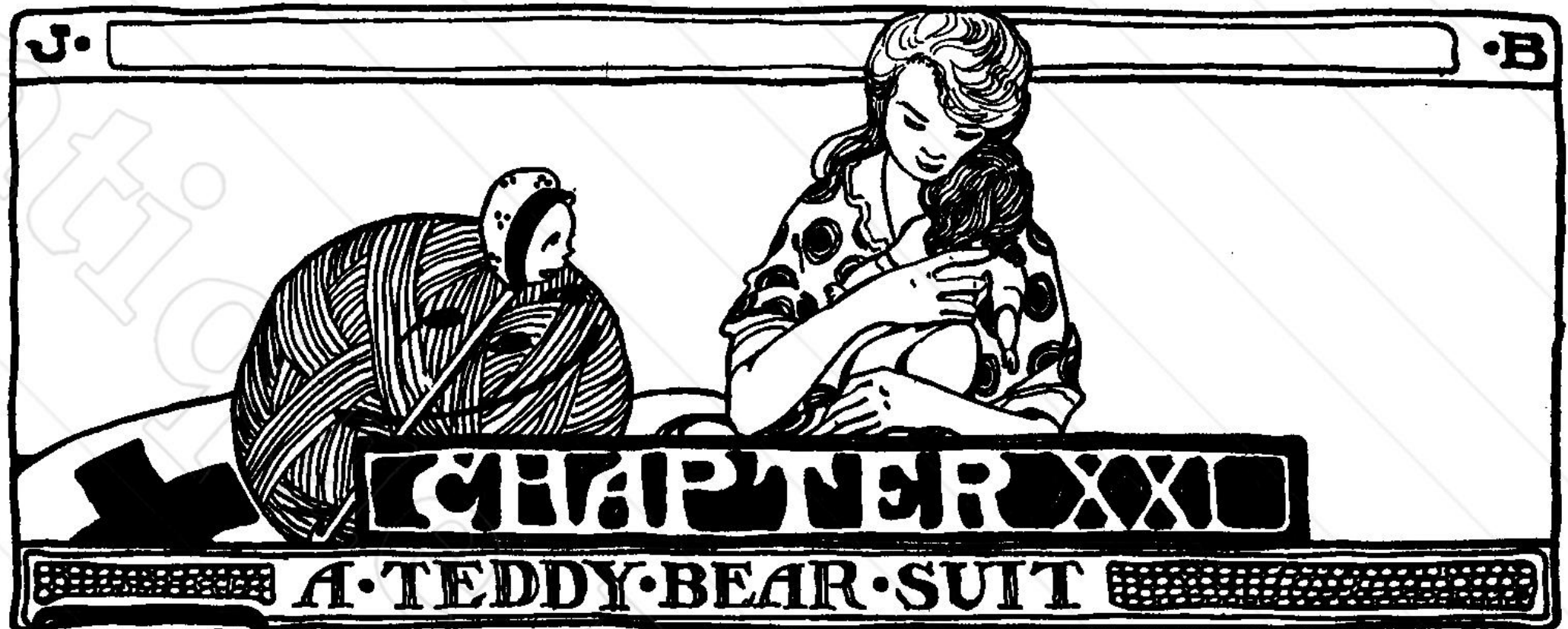

DO wonder what the Crochet People have planned for the next lesson," thought Mary Frances as she went upstairs after breakfast the next morning.

When she went into the playroom she was surprised to find Mary Marie sitting on the side of her bed, trying to put on her little slippers.

"What!" exclaimed Mary Frances. "Awake so early—and trying to dress yourself?"

"'Es, Mamma," answered Mary Marie. "I'se detting weady to doe to tool."

"Bless your little heart!" cried Mary Frances. "I do
"Here, let me help you!" and she soon put on Mary Marie's little shoes and stockings, and dressed her.



[127]



Put on her little slippers.

"What shall I wear wound me, Mamma?" asked the dolly. "It's too warm for a toat, and too told to doe wifout somet'ing wound me."

"Let me see," said Mary Frances, thinking hard.

"If Mary M'rie only had a twetter!" sighed the wise young lady.

Mary Frances caught her up in her arms. "The very thing!" she cried. "Let us go see the Crochet People."

Just as she sat Mary Marie on the table, Crow Shay began:



Crow Shay
began.

"For young or old,
When it is cold,
Nothing is better
Than a sweater."

"Oh!" exclaimed Mary Frances. "Oh, Crow Shay, how did you ever guess what we want so much?"

"Every doll in the world ought to have a sweater," he declared. "And the sooner Fairly Flew comes, the sooner Mary Marie will get one."

So Mary Frances said the magic rhyme:



"If I only had a twetter!"

"Fairy Fairly Flew,
Please come, for I need you;"

and the fairy helper came.

"What do you wish for?" she asked, seating herself in the doll's rocking-chair.

"A sweater for Mary Marie, dear Fairly Flew," Mary Frances answered.

"A twetter! A twetter!" laughed the little doll, looking up. "Doe to tool."

"Bless her heart—and yours, too, little girl," said Fairly Flew; "she shall have not only a sweater, but a whole outfit to keep her warm when she goes to school, for I myself will give you directions for making a—

TEDDY BEAR SUIT

Consisting of Sweater, Tam, and Long Leggings

(See picture opposite page 168—color plate.)

Material: "Old blue" or peacock blue knitting worsted.
Bone crochet hook No. 5.

DOLL'S CROCHETED SWEATER

(Be sure to make the articles already described in this story before attempting to make the Teddy Bear Outfit.)



"What do you wish for?"



"A twetter! A twetter!"

Directions:

This work is begun with the front.

1. Make 26 chain stitches.
2. Make 25 single crochet stitches.
3. Make 1 chain to turn. Always make 1 chain stitch to use in turning, unless told to do otherwise.
4. Make 12 rows (in all) of 25 single crochet stitches, taking up both loops of stitches below.

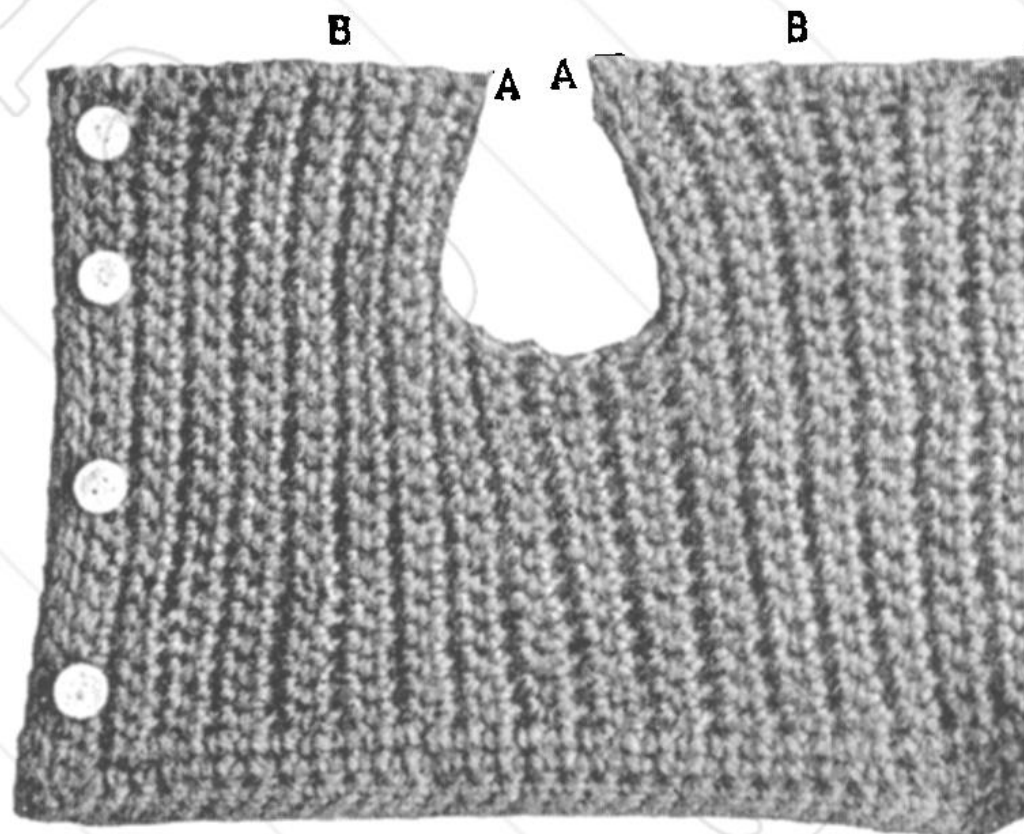

5. On the thirteenth row, make only 15 single crochets. Make only 15 single crochets for 6 rows (in all). These rows come under the arm of the doll. You will then have made 18 rows.

6. On the nineteenth row, make 15 single crochets and 11 chain stitches.

7. On the twentieth row, make 25 single crochets.

8. Make 21 rows of 25 single crochets for the back of the sweater. This makes 39 rows from the beginning.

9. On the fortieth row make 15 single crochets for 6 rows, under arm.

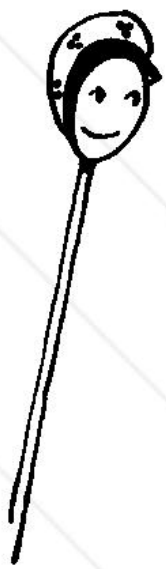

"A really sweater!"

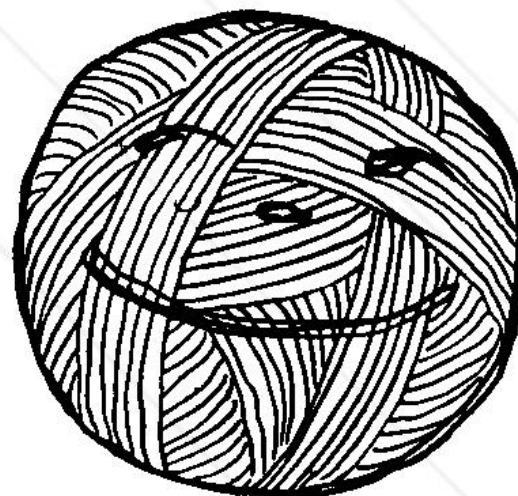

"Oh me! Oh my!"

A TEDDY BEAR SUIT

131

10. On the forty-seventh row, add 11 chains, and crochet 12 rows of 25 single crochet stitches.



To Make Armholes

Thread a zephyr needle with the worsted, and sew 6 rows of the front to 6 rows of the back (A to A, B to B. See picture, page 130). Do the same to the other side.

To Make Border on Edge around Sweater

1. Hold the outside of the sweater toward you. Starting at the left side of the neck, take up both loops of each stitch with single crochet all around sweater to right side of neck.



"Does it
fit?"



Try on Dolly.

NOTE.—In turning corners at bottom use 3 single crochets in 1 stitch.

2. Make 1 chain stitch to use in turning, and make another row of single crochet in the same way all around sweater. This will bring you back to the starting stitch of border.

3. Make 1 chain to use in turning, and make third row, putting only 2 single crochet stitches in corners at the bottom.

To Make Collar Band

1. Hold right side of front of sweater toward you, and take up each stitch across the neck with single crochet.

2. Make 5 rows of single crochet, using 1 chain stitch to turn.

Make slip stitches all around sweater taking up back thread only of the stitches.

To Fasten Sweater

The sweater is fastened with loops and buttons.

To Make Loops

Chain stitch
form loops.

1. On the right-hand side of the sweater, commencing at the bottom, make 4 slip stitches.

2. Make 2 chain stitches.

3. Skip 2 stitches in the row below, and make 4 more slip stitches. The chain stitches form the loops.

4. Continue doing this until the neck is reached.

5. Make 1 loop on the end of the collar. Sew buttons on the left side opposite the loops.

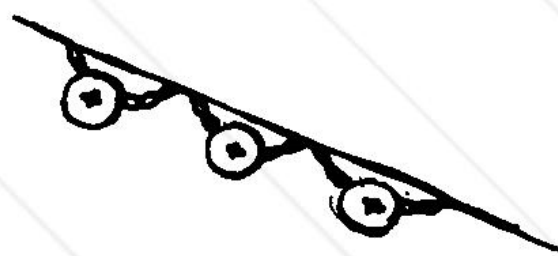

Fastened with loops and buttons.

To Make the Sleeves

1. Make 9 chain stitches.
2. Make 8 single crochet stitches.
3. Always make 1 chain stitch to use in turning single crochet.
4. Second row: Taking up both threads of the row of single crochets just made, make 2 single crochets in the first stitch, and

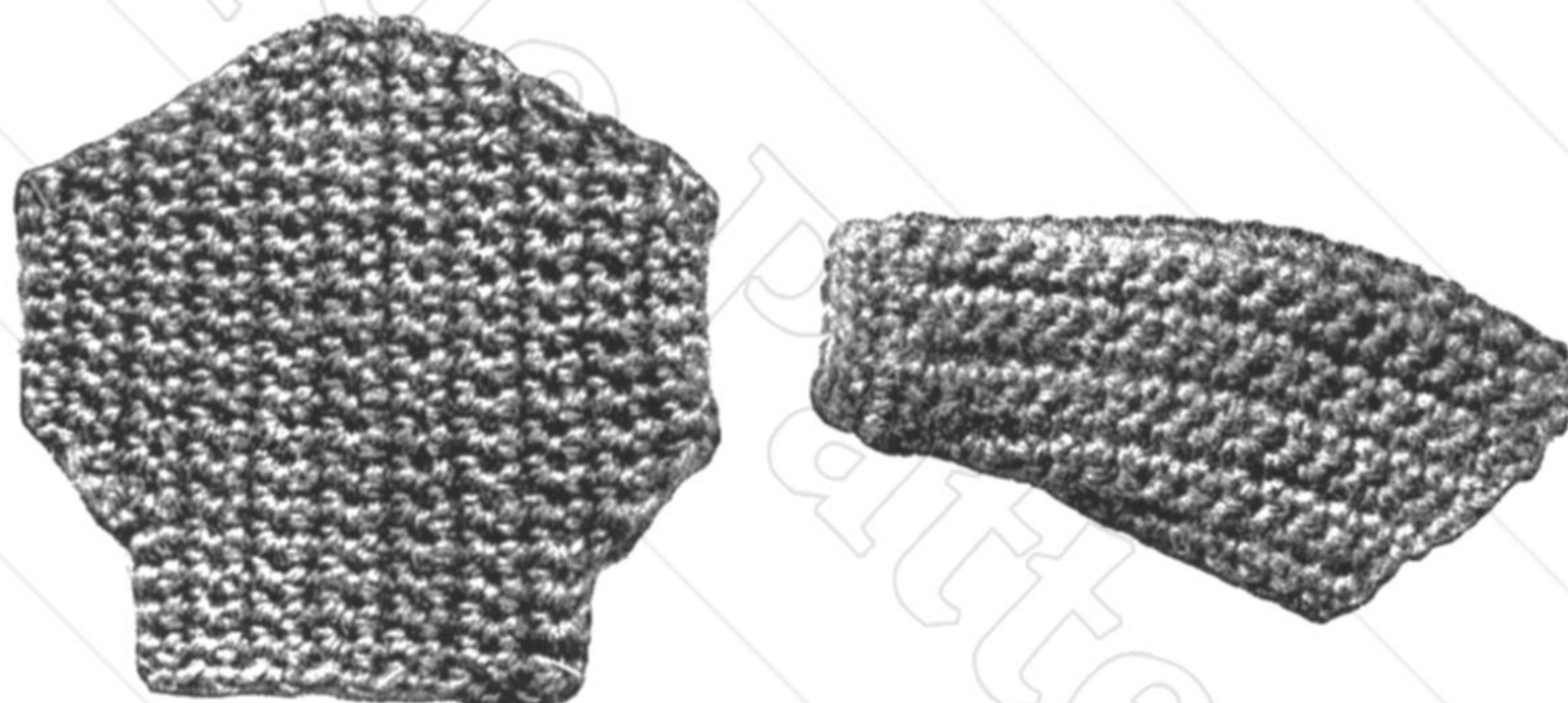

1 in each stitch to the end of the row. This will make 9 stitches.

5. Make 3 chains, and turn the work.

6. Third row: Make 1 single crochet in each of the two chain stitches, and single crochets to the end of the row, making 11 stitches in all. Make 1 chain to turn.

7. Fourth row: Make 2 single crochets in the first stitch and single crochets to the end of row, making 12 stitches in all.

8. Fifth row: Make 5 chain stitches. Make 4 single crochets

*Busily
crocheting.*

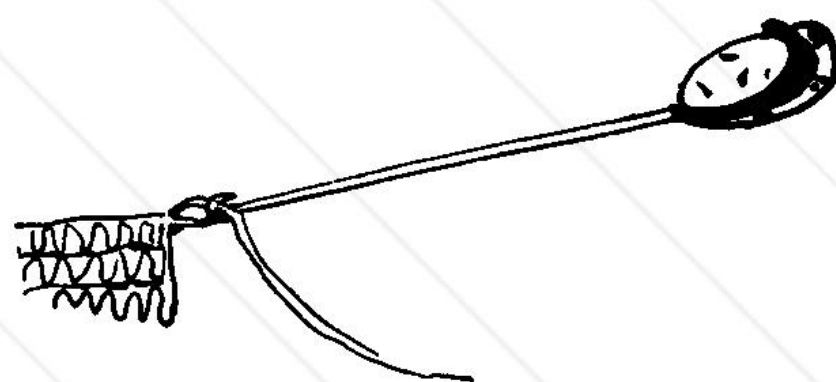

Chain stitch to use in turning.

in the chain stitches, and single crochets to the end of row, making 16 stitches.

9. Sixth row: Make 2 single crochet stitches in the first stitch and single crochets to the end, making 17 stitches.

10. Seventh row: Make 17 single crochets.

11. Eighth row: Make 2 single crochets in first stitch and single crochets to the end of row, making 18 stitches.

12. Make 6 rows of 18 single crochet stitches.

13. On the fifteenth row, make single crochets, but skip next to the last stitch, making 17 single crochet stitches.

14. Sixteenth row: Make 17 single crochet stitches.

15. Seventeenth row: Make single crochets across row, but skip next to the last stitch, making 16 stitches.

16. Eighteenth row: Make 16 single crochet stitches.

17. Nineteenth row: Make slip stitches in the first four stitches. Single crochet to the end, skipping next to the last stitch, making 11 stitches.

18. Twentieth row: Make 11 single crochet stitches.

19. Twenty-first row: Make 2 slip stitches, and single crochet to the end of row, skipping next to the last stitch, making 8 stitches.

20. Twenty-second row: Make 8 single crochets. Break off and fasten the yarn.

Make another sleeve like this one.

21. Sew up the sleeves.

22. Pin seam to the front corner of the armhole (A) and sew in place. (See picture, page 131.)



"Row! row!
another row"

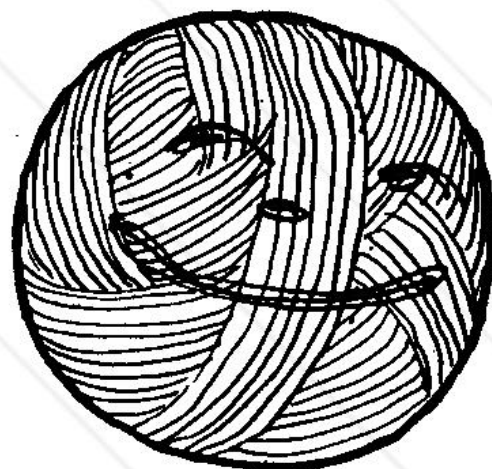

"Look out, Crow Shay!"

A TEDDY BEAR SUIT

135

23. Put 2 rows of single crochet around the end of sleeve at wrist.

Add one row of slip stitches below these. Do not make this row of slip stitches very tight.

To Make the Pockets

1. Make 7 chain stitches.
2. Make 7 rows of 6 single crochets.
3. Put 1 row of single crochet across the top of pocket.
4. Put 1 row of slip stitches across top of pocket.



Make another pocket in same way.

Sew pockets on the sweater, about 1 inch from bottom and 1 inch from sides.

DOLL'S CROCHETED TAM

(See picture on page 136)

Material: Old blue or peacock blue knitting worsted.

Bone crochet hook No. 5.

Directions:

1. Make 4 chain stitches.
2. Join the chain in a ring with slip stitch.
3. Make 10 single crochets into the center of the ring.
4. Tie a piece of white sewing thread to the tenth single crochet stitch, to mark the beginning of the next row around.
5. Second round. Make 2 single crochets in each stitch,



Join in
a ring.



Sew pocket on sweater.

taking up back loop of thread in each stitch of row just finished.

6. Third row: Make 2 single crochets in the first stitch, 1 single crochet in the next stitch, and continue making 2 single



DOLL'S CROCHETED TAM

crochets in the next stitch and 1 single crochet in the next stitch to the end of the round.

7. Fourth round. "Increase," or put 2 single crochet stitches in every third stitch. Make 1 single crochet in the other stitches.

8. Fifth round. Increase in every fifth stitch.

9. Sixth round. Make 1 single crochet in each stitch.

10. Repeat fifth and sixth rounds until there are 11 full rows. The work should measure about 5 inches across.

11. Twelfth round. Begin to "decrease," or narrow, the tam to fit the head of doll.



**"Increase!
Increase!"**



"Don't I look tweet?"



BABY BLUE AND BABY PINK

FOR DIRECTIONS FOR MAKING KNITTED ARTICLES SHOWN IN THIS ILLUSTRATION SEE

BEDROOM SLIPPERS—108

CROCHETED SOCKS—228

CROCHETED CAP—229

CROCHETED SACQUE, No. 2—232

CAPE AND HOOD—236

BABY'S BALL—107

Antique Pattern Library

How to "Decrease" in Crocheting

Pull a loop through of each of 2 stitches, and take them off the crochet needle as if they were one loop, thus forming a single crochet; that is, pull a loop through the 3 loops then on the needle. (See picture below.)

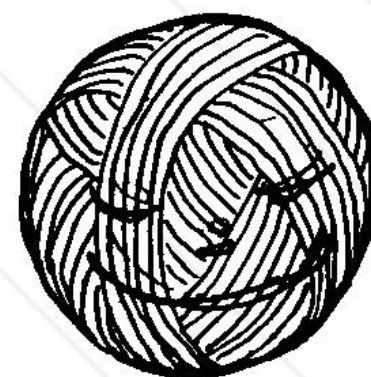
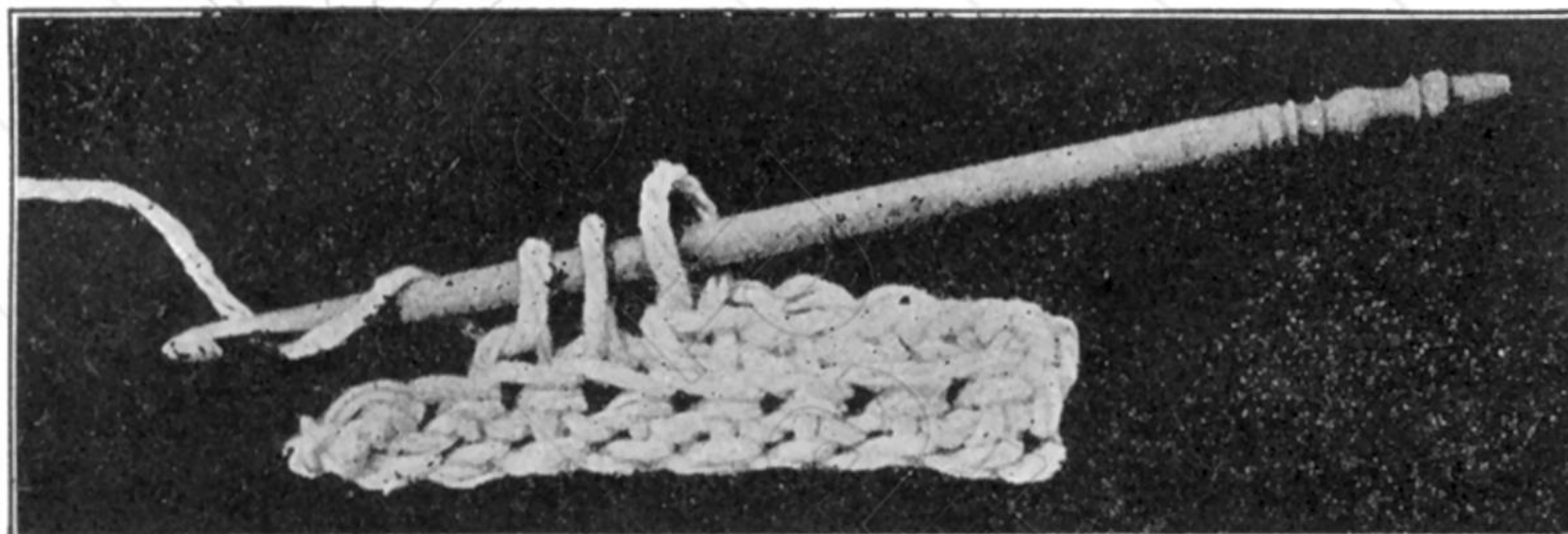

On the twelfth round of the tam, decrease on the first 2 stitches, then make 5 single crochet stitches. Then decrease on next 2 stitches and make 5 single crochets. Continue decreasing in this way until tam fits doll's head.

About 4 rows of decreasing will be needed, which makes 15 full rows from starting place. Do not break off yarn, but learn how—

"Can you read?"

To Make the Head Band

Make 4 rows of single crochet, taking up both threads of stitches in rounds just finished. Break off the yarn and fasten



"Won't this be lovely?"

the end by making a slip stitch and pulling end all the way through the last loop.

To Make the Tassel

1. Cut a strip of cardboard, making it $1\frac{1}{2}$ inches wide and about 2 inches long.
2. Cut off 2 pieces of yarn, each measuring 1 yard, lay them together, side by side.
3. Wind the 2 pieces of yarn over the narrower part of the cardboard.
4. Tie as in making tassels for doll's slippers. (See Plate 3.)
5. Make 18 chain stitches, and fasten tassel to the chain as on runner for doll's slippers. Put the other end of the chain through the hole in the center of the top of the tam, and sew it down in place on the wrong side.

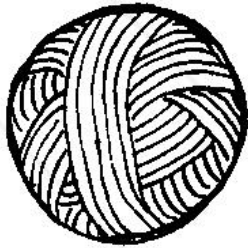

Blue
worsted.

CROCHETED TEDDY BEAR LEGGINGS

(See pictures on pages 139 and 140.)

Material: Old blue or peacock blue knitting worsted.

Bone or celluloid crochet hook No. 5.

Directions:

This work is begun at the waist line.

1. Make 50 chain stitches.
2. Join chain with slip stitch and make 1 chain stitch to use in turning.
3. Make 1 single crochet in each stitch of the chain, making

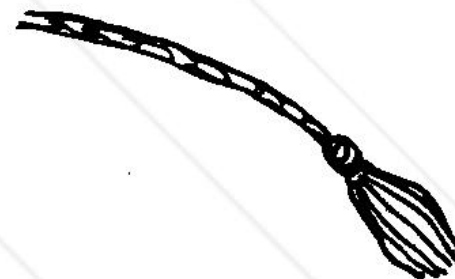

Make tassel.

A TEDDY BEAR SUIT

139

50 single crochets. Join last single crochet stitch to first single crochet with slip stitch. Make 1 chain stitch to use in turning.

4. Make 5 rows of single crochet stitches, taking up both loops of each stitch in row below. Join end stitch with first as explained in direction No. 3.

5. On the sixth row, in order to form the fullness in the seat, make 38 single crochet stitches. Turn without making a chain stitch. Make 26 single crochets. Turn again without a chain stitch, and continue making single crochet to end of row, or joining point.

6. Make the seventh, eighth, ninth, tenth rows of single crochet stitches.

7. Make the eleventh row in the same way as



FRONT OF LEGGINGS



"Eleventh row?"

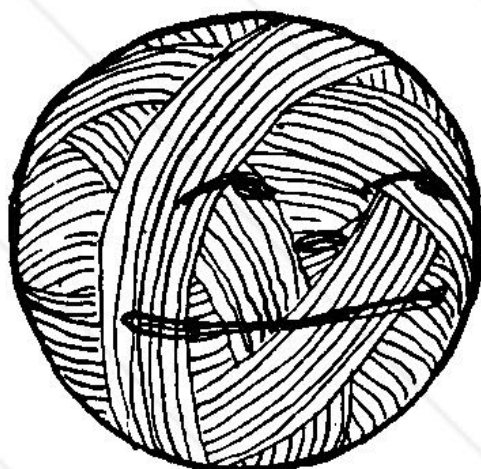

"Yes, Stupid!"



you made the sixth row. (See direction No. 5.)

8. Make the twelfth row of single crochet.

9. On the thirteenth row begin to decrease the stitches, or to narrow the work. When you reach the twelfth stitch, take off 2 stitches as one. Do the rest of the row in single crochet except when you reach the thirty-eighth stitch, when you take off 2 stitches as one. There should be 48 single crochet stitches in the thirteenth row.

10. Continue to make 48 stitches in each row until there are 18 rows in front. Do not break off the yarn. You will have a loop on the crochet needle.

You will use this loop in making the separation for the leg part of the Teddy Bear Leggings.

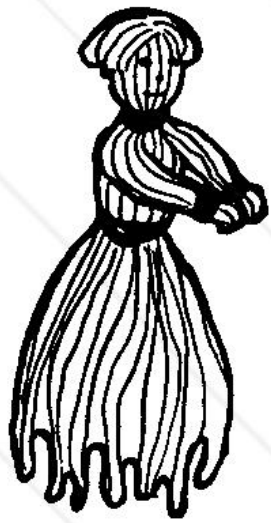

"A perfect fit!"

BACK OF LEGGINGS



Trying on.

11. With the loop on the crochet needle, put the hook through the twenty-fourth single crochet stitch, on the opposite side, throw the yarn over the hook, and pull it through both stitches. Now you will work in a circle around the leg.

12. Make 24 single crochet stitches, and join the twenty-fourth to the first stitch in the leg part, with a slip stitch. Make 1 chain to turn. This is the nineteenth row of the garment.

13. Make the twentieth row of single crochet and join last and first stitches.

On the twenty-first row, begin to narrow the leg. Make single crochet stitches until you reach the eleventh stitch. Then take off 2 stitches as one. Continue with single crochet to end of row and join stitches.

14. The twenty-second, twenty-third and twenty-fourth rows are of single crochet.

15. The twenty-fifth row is like the twenty-first row.

16. The twenty-sixth, twenty-seventh and twenty-eighth rows are of single crochet.

17. The twenty-ninth row is like the twenty-first row. There should be 21 single crochet stitches in the twenty-ninth row.

18. Continue to make 21 single crochet stitches in each row until you have 47 rows from the waist line in front.

19. Next you will make the strap underneath the doll's foot.

Make 5 chain stitches, and join the last one to the ninth single crochet stitch with a slip stitch.

20. Put 1 slip stitch in each stitch of chain for the strap.



“Chain, chain
stitch,
stitch.”

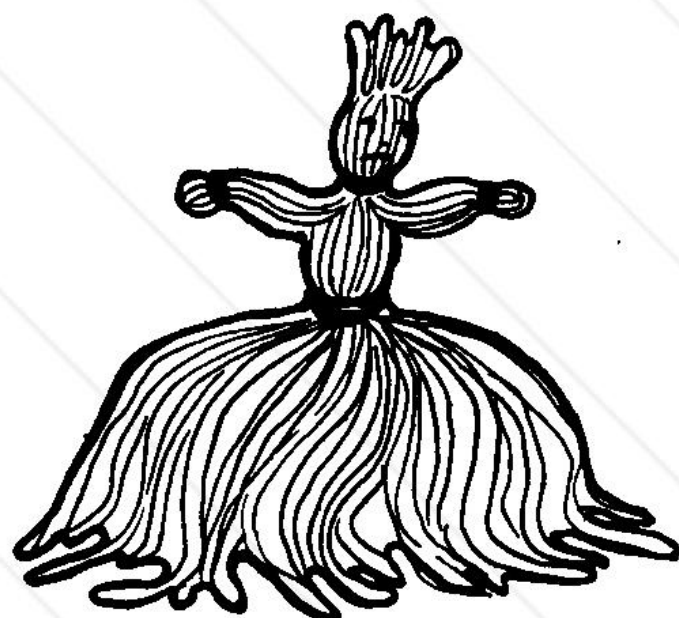

“Will you be quiet?”

142 KNITTING AND CROCHETING BOOK

Do not break off the yarn. Next you will make the toe part of legging.

21. Make 3 slip stitches, putting them into the single crochet stitches nearest the strap toward the front of the legging.

22. Make 4 single crochet stitches and 1 chain stitch to use in turning.

23. Make 4 rows of single crochets.

24. Now make slip stitches all around the bottom of the legging to make a neat finish.

25. Make another leg like this one. Begin the work at the inside seam or joining point of the leg just made. Start this row at the back of the legging.

Next you will make spaces for a runner at the waist.

At the top of leggings at the joining point, or seam, fasten yarn ready to begin new work.



Put hook through.

To Join New Thread

Put the hook through the stitch at the place where you need the new thread. Throw thread over hook, and pull the end of the thread through the stitch and tie in a single knot. Thread end into a zephyr needle, and run it into the work.

See also page 231.

To Make Runner Spaces

1. Make 3 chain stitches.
2. Put a double crochet in each of the next 14 stitches.
3. Make 20 treble crochet stitches. (See picture of treble crochet, page 228.)



“Won't I be warm?”

4. Make 14 double crochets.

5. Join with a slip stitch the last double crochet stitch to the third chain stitch. See direction No. 1, above.

To Make the Runner

Make a chain of 75 stitches, and thread through the runner spaces as in making the doll's petticoat. (See page 90.)

Fairly Flew gave the directions so rapidly that Mary Frances scarcely realized when she finished one piece of the little Teddy Bear suit and commenced on another.

When the three pieces were finished, "Good!" exclaimed the fairy. "The reason that I talked so fast was that I was so anxious to see how your baby would look when dressed like a Teddy Bear."

"Come here, dear," said Mary Frances, holding out her arms, and Mary Marie ran to her.

"Twick, Mamma! Twick!" she cried, trying to get into the sweater by herself.

Mary Frances helped her and soon she was dressed.

"Doesn't she look dear!" exclaimed Mary Frances, kissing her.

"She looks too cunning for anything!" said the Yarn Baby.



Fairly
Flew.



"Twick, Mamma! Twick!"

"I could roll yarn for her all my life," declared Wooley Ball.

"Isn't it wonderful to make such a beautiful thing out of a string?" asked Crow Shay. "I should think that everybody would learn to know us nice Crochet People."

"I should, too," said Mary Frances. "I wish all my friends——"

"Hush!" exclaimed Fairly Flew. "I think I hear a step!" And she melted out of sight.

"Tate Mary M'rie for a walk, Mamma?" the little doll asked as Mary Frances took her up in her arms; but when they reached the foot of the stairs, Mary Marie began to look like a doll again, and stared at things just as dolls do.

"She is afraid some one will see her, and the fairy has told her not to talk," thought Mary Frances. "I guess I'll take her upstairs again so as to be safe." And she went to the playroom.

"Nice walk," said Mary Marie, leaning her head on Mary Frances' neck sleepily. So Mary Frances undressed her and put her to bed and then went out to play.



"I should
too."

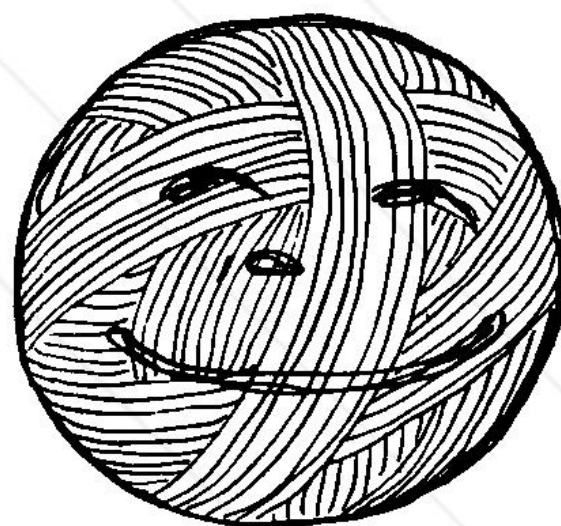

"I could roll yarn all my life."

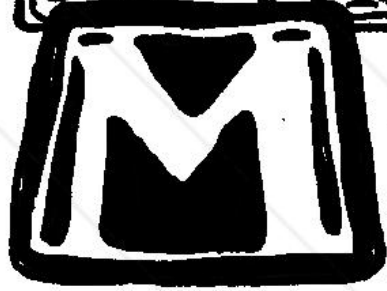

MARY FRANCES stopped at the door of the sewing room when she went upstairs the next morning after breakfast, for she was sure that she heard a voice.

Crow Shay was speaking—

“Now then unpack,
Both Knit and Knack,
For Fairly Flew
Has need of you.”



“Did she say so?” asked a little voice eagerly.

“Did she say so?” asked another little voice just as eagerly.

“Did she say so?”

[145]



“Now then unpack.”

"Not exactly, not exactly," answered Crow Shay; "but I saw her working on some knitting."

"That's a sign, I guess," said Knit.

"That's a sign, I guess," said Knack.

And they both jumped out of the knitting bag.

"Come, Wooley Ball," cried Knit, "please help us."

"Come, Wooley Ball," cried Knack, "please help us."

"Help you what?" asked Wooley Ball, rolling over toward them.

"Help us teach the little Miss to knit," replied Knit.

"Help us teach the little Miss to knit," echoed Knack.

"I'll help you!" Crow Shay offered.

"You?" cried Knit. "You only crochet!"

"You?" cried Knack. "You only crochet!"

"Only?" exclaimed Crow Shay. "Only? Well, if I ever betted, I'd bet you both that I can help teach knitting."

"I'd like to see you!" said Knit.

"I'd like to see you!" said Knack.



"I'll help you!"

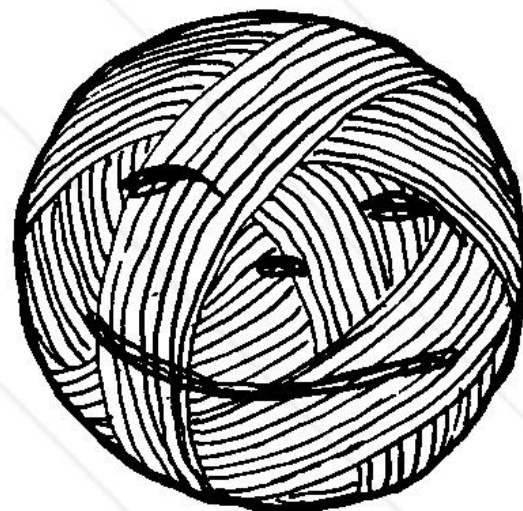

"Help you what?"

"Maybe you will," laughed Crow Shay. "I'm willing to help you," he added.

"Come," thought Mary Frances. "If that little mischief keeps on, there will be a quarrel. I must go in," and she entered the room.

"Why, how do you do, my new friends?" she said, speaking to Knit and Knack.

"Oh, they are pretty well, thank you," answered Crow Shay. "Good-morning, Miss Mary Frances."

The Yarn Baby's hair rose high on her head. "Wait till you're spoken to, Crow Shay!" said she.

Crow Shay stepped back on the table.

"You are Knit and Knack, my knitting needles. I know you well," went on Mary Frances. "I do hope that you will help me learn to knit."

"They're crazy to," began Crow Shay, "and I am——"

The Yarn Baby gave him such a hard push with her soft little elbow that he toppled off the table.

Then the Knitting twins had to laugh. They couldn't help it.

"Oh, dear!" sighed Mary Frances, picking him



Toppled off the table.



"Wait till you're spoken to!"

up. "Oh, dear! He is so anxious to help that he forgets his manners; but he will learn some day."

"I'll call the fairy," thought the little girl, and she said her magic rhyme.

"Why, everybody is all ready for the next lessons," said Fairly Flew, looking around after she had greeted Mary Frances. "We will start at once—

To Make a Slip Knot

Material: About 2 yards four-fold Germantown wool.
One pair bone knitting needles No. 6.

CUT 1

Hold yarn in hands as shown in this picture.

CUT 2

Let upper thread fall behind the second finger of left hand.

CUT 3

Catch it between the first and second fingers.

CUT 4

Pull hard on the thread in the right hand bringing the loop off the left-hand fingers.

CUT 5

Draw knot up tight.

CUT 6

Slip the loop on a knitting needle and draw it up close.



"I'll call
the fairy."



"We will start at once."

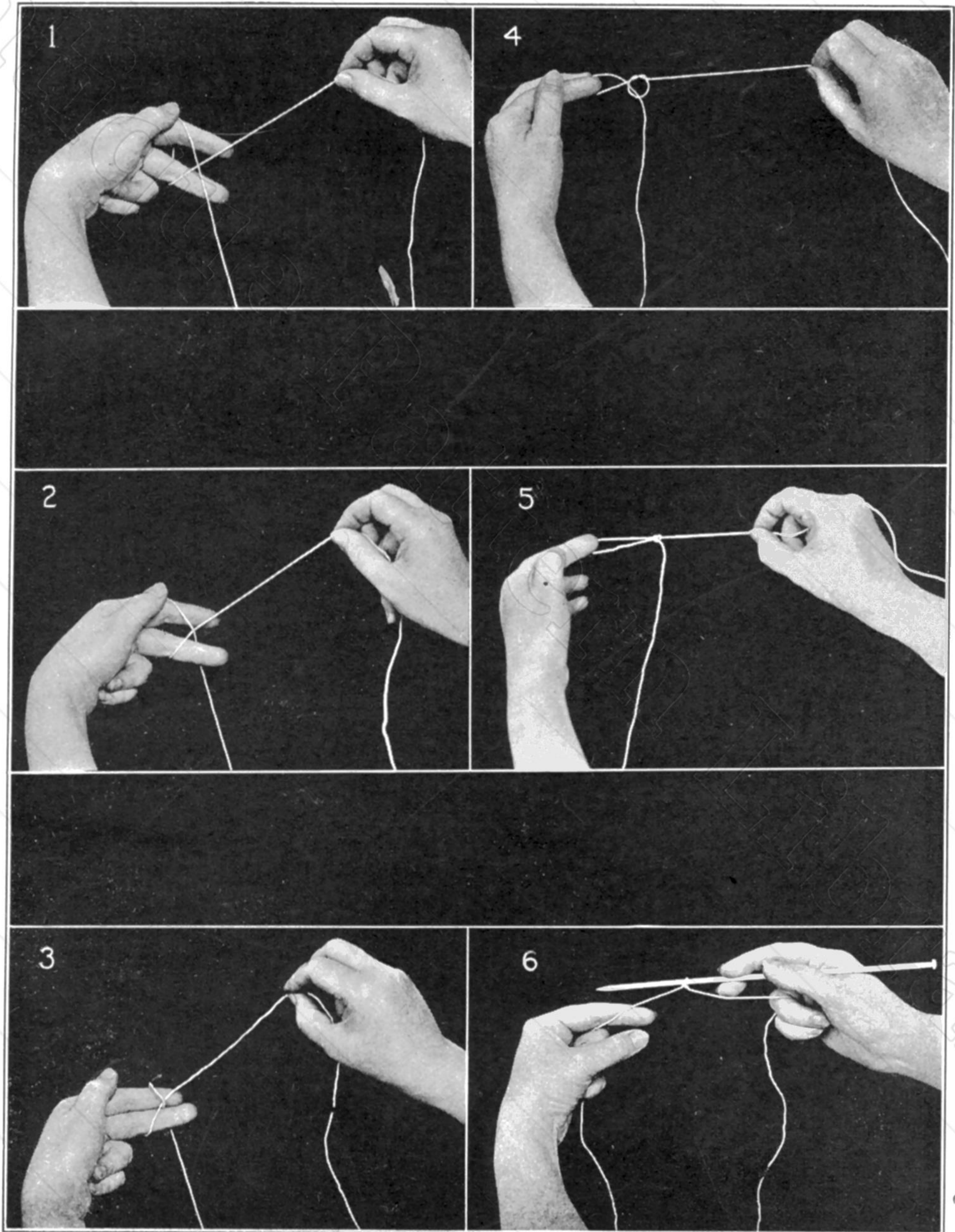

PLATE 4—MOTION PICTURES SHOWING THE RIGHT WAY TO MAKE A SLIP KNOT—FIRST STEP IN KNITTING. SEE PAGE 148

Antique Pattern Library



MARY FRANCES found that her fingers were pretty clumsy in doing this exercise. She wished that Fairly Flew would give her a magic lesson.

"No," said the fairy, as though reading her thoughts, "I cannot do that. Everybody has to learn in the same old way—by—trying—"

'If at first you don't succeed,
Try, try again.' "

Mary Frances tried harder than ever, and when she had made a slip knot, every one looked delighted. "No, I cannot do that."



[149]

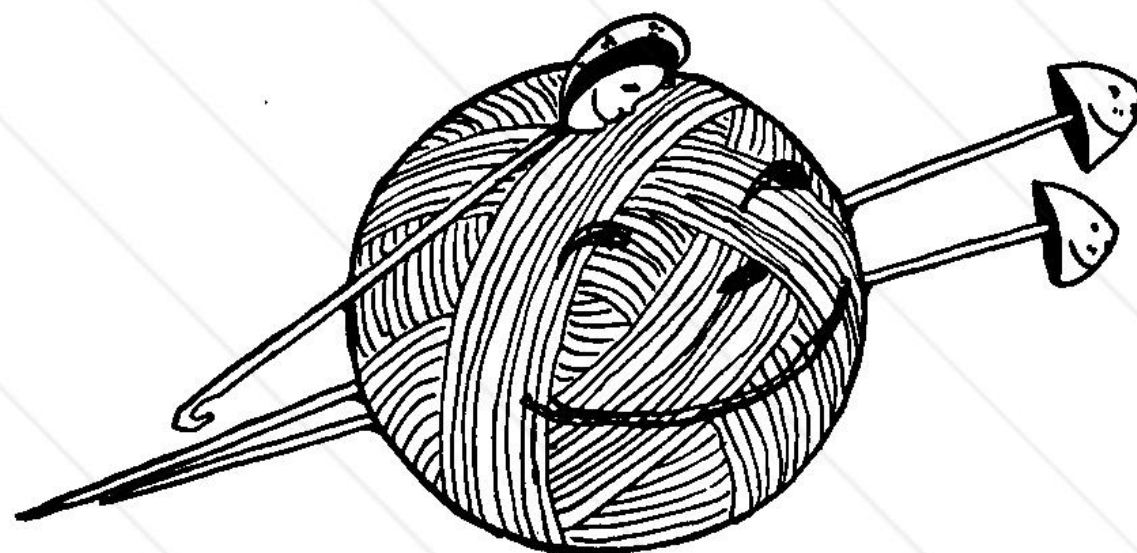

Every one looked delighted.

"Now," said Fairly Flew, "now, you are ready to try a new exercise."

"Now, it is Knit or Knack's turn," thought Mary Frances, as she took up a knitting needle. It happened to be Knack.

The fairy smiled and nodded her approval; then she said, "Now, pay very careful attention, and try

TO CAST ON STITCHES WITH THE FINGERS

Material: About 2 yards four-fold Germantown wool.
One pair bone knitting needles No. 6.

CUT 1

Make slip knot about one-half yard from end of yarn. Draw it up on one knitting needle, holding yarn in position shown in this picture.

CUT 2

Catch hold of the shorter end of yarn with the left hand, and hold hands in the positions shown in this picture.

CUT 3

Turn the left hand around to the position shown in this picture. With the right hand push the needle farther through the loop on left thumb, and with the first finger of the right hand throw the yarn over the point of the needle.



It happened
to be Knack



"Now, pay attention."

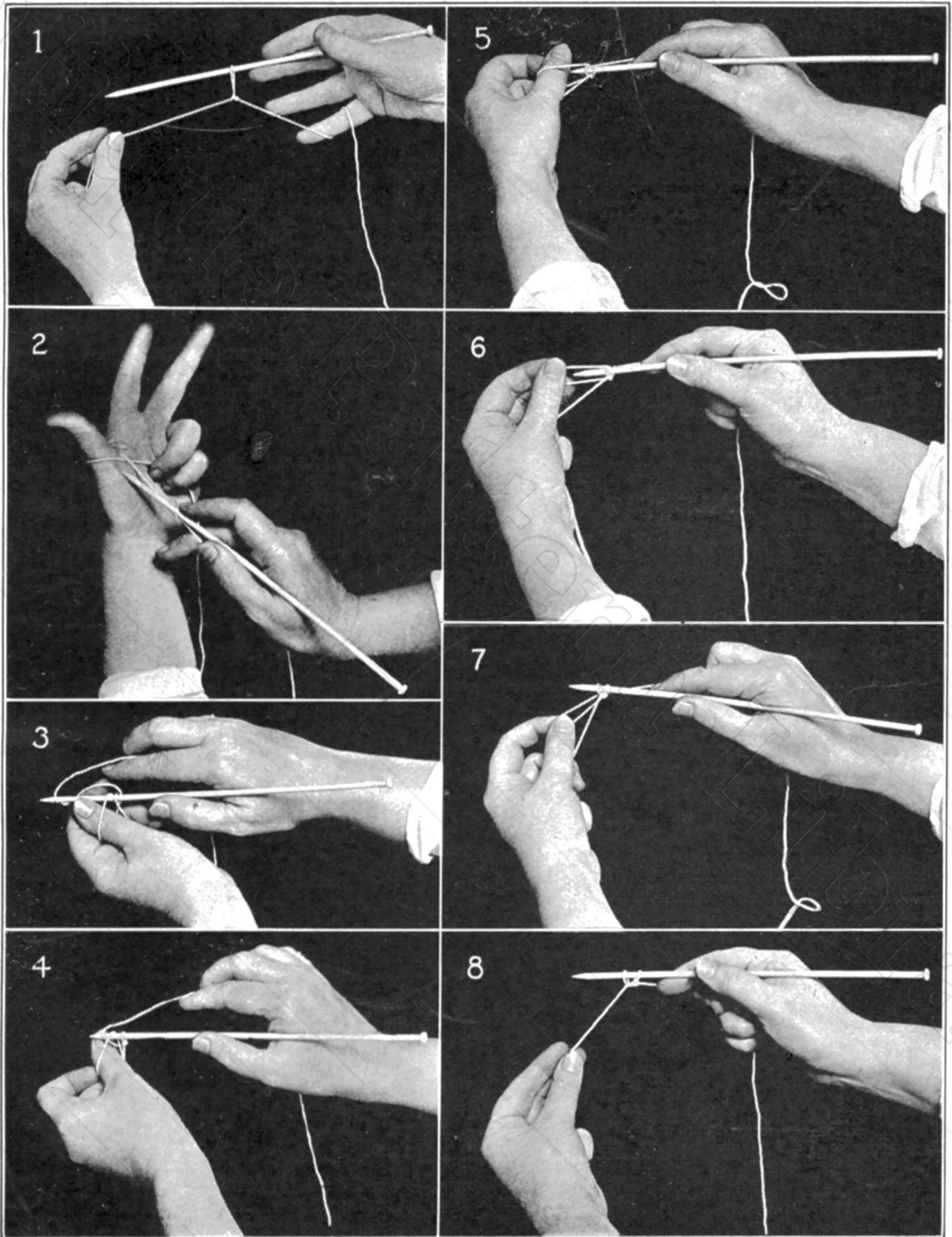

PLATE 5—MOTION PICTURES SHOWING HOW TO CAST ON KNITTING STITCHES WITH THE FINGERS. SEE DESCRIPTION, PAGE 150

Antique Pattern Library

CASTING ON STITCHES

151

CUT 4

Draw the yarn tight and

CUT 5

bring the needle toward you through the loop on the thumb.

CUT 6

Push the loop backward from the point of the needle.

CUT 7

Pull the loop downward.

CUT 8

Let go of the loop and catching hold of the end of yarn in the left hand with the fingers and thumb, draw the loop up tight against the needle.



Look
out!"

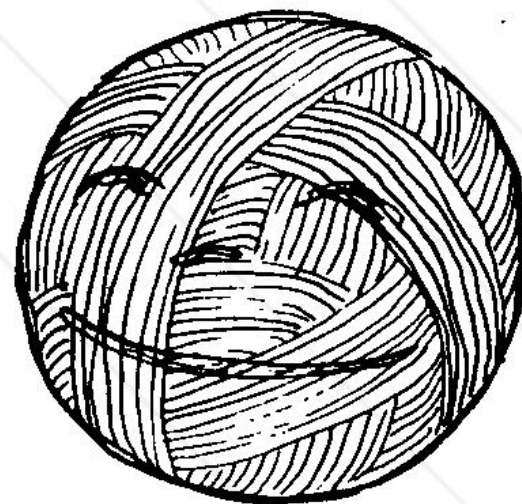

"Try, try again!"



"Will you two keep still?"



EVERYONE watched Mary Frances as she tried to follow Fairly Flew's instructions; but the little girl had to try several times before she could do the exercise well.

"You didn't get the knack of it at first," said the Yarn Baby, "but you do splendidly now."

"She has had Knack in the hand all the time," whispered Crow Shay to Knit, who began to laugh.

Hearing Knit laugh, Knack began to laugh, too.

"Why, I can scarcely hold this needle still!" exclaimed Mary Frances, and Knack and Knit stopped giggling.

"You made them laugh!" whispered the Yarn Baby to Crow Shay, but he pretended not to hear.

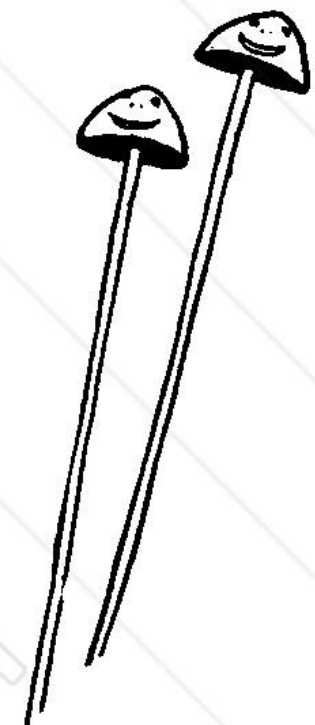

Knit and
Knack laugh



"It is all your fault!"

"The first work in knitting," said Fairly Flew, "is the casting of stitches or loops on one knitting needle. There are several different ways of doing this."

"Yes," said the little girl, "I have seen Aunt Maria cast on stitches with two knitting needles."

"You will learn that method later on," Fairly Flew promised; "but next—"

She did not finish the sentence because Crow Shay was attracting everybody's attention by his funny antics. He couldn't seem to keep still, but kept hopping up and down on the table so hard that it made a constant tap-tap-tap!

"Watch me, Knit," he was whispering, "you'll soon be surprised to see me help you." Then he began to giggle.

"The little tease!" exclaimed Fairly Flew. Then turning to Mary Frances she continued: "I see that you have your needle well filled with cast-on stitches. They look nice and even, and you could knit them off quite easily when shown how to use the other needle; but before you learn to take stitches off, I wish to tell you about another easy way to cast on stitches."



"Yes, I see."

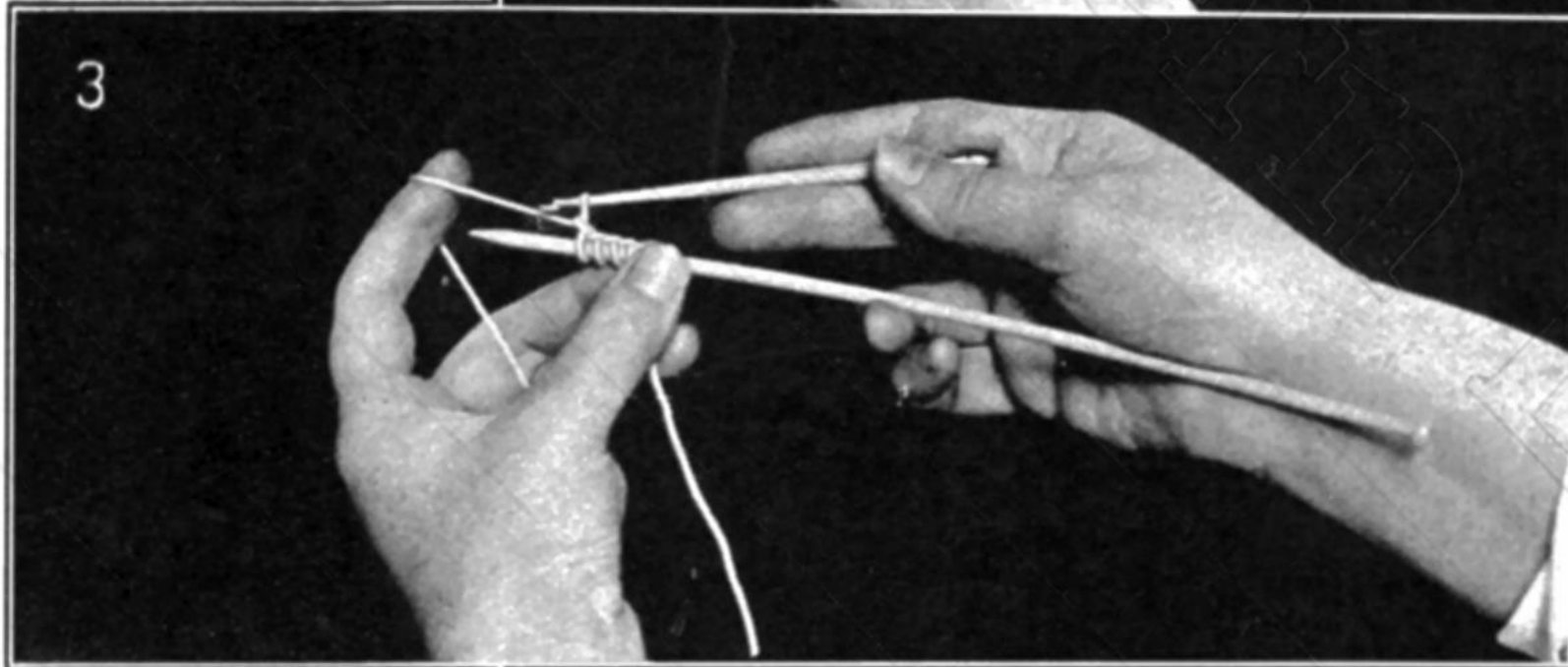
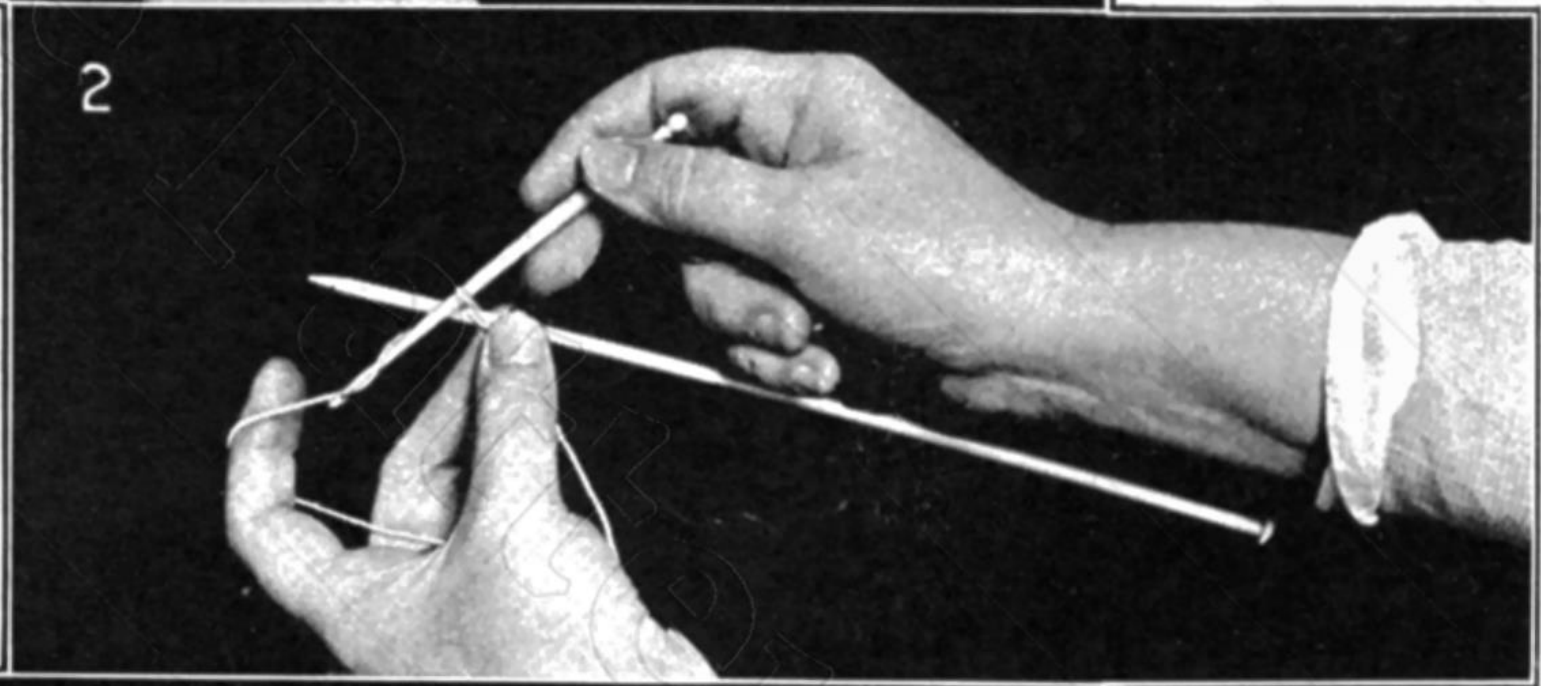
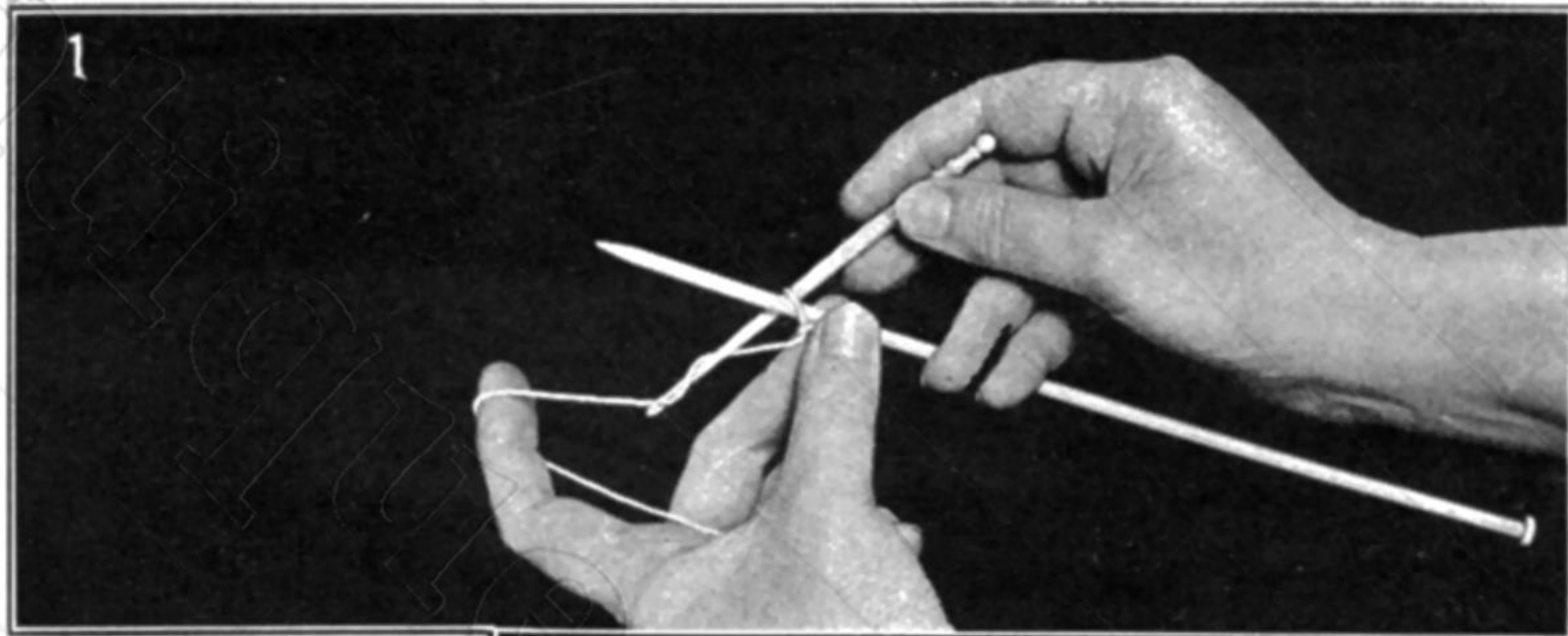

PLATE 6—MOTION PICTURES SHOWING HOW TO CAST ON KNITTING STITCHES WITH A CROCHET HOOK. SEE DESCRIPTION, PAGE 155

Antique Pattern Library

TO CAST ON STITCHES WITH A CROCHET HOOK

(See picture on opposite page)

Material: Germantown zephyr.

One pair bone knitting needles No. 6, crochet hook No. 3.

CUT 1

1. Make a slip knot in the end of the yarn and slip it on the knitting needle. Do not pull the slip knot very close to the needle. Hold slip knot with thumb and second finger of left hand and with right hand slip the crochet hook into the slip knot back of the knitting needle. Put hook under yarn and pull a loop through the slip knot. Still hold slip knot with thumb and first finger of left hand.

CUT 2

2. Bring the crochet hook in front of the knitting needle; wrap, and draw a loop through the loop on the crochet hook.

CUT 3

3. With first finger of left hand throw the yarn back over point of knitting needle,

CUT 4

and make another stitch with the crochet hook.

Continue doing this until the number of stitches wanted are cast on the needle. Slip the last loop on the crochet hook over the point of the knitting needle.

*Other methods of casting on stitches are shown on pages 150 and 281.



To cast
on.

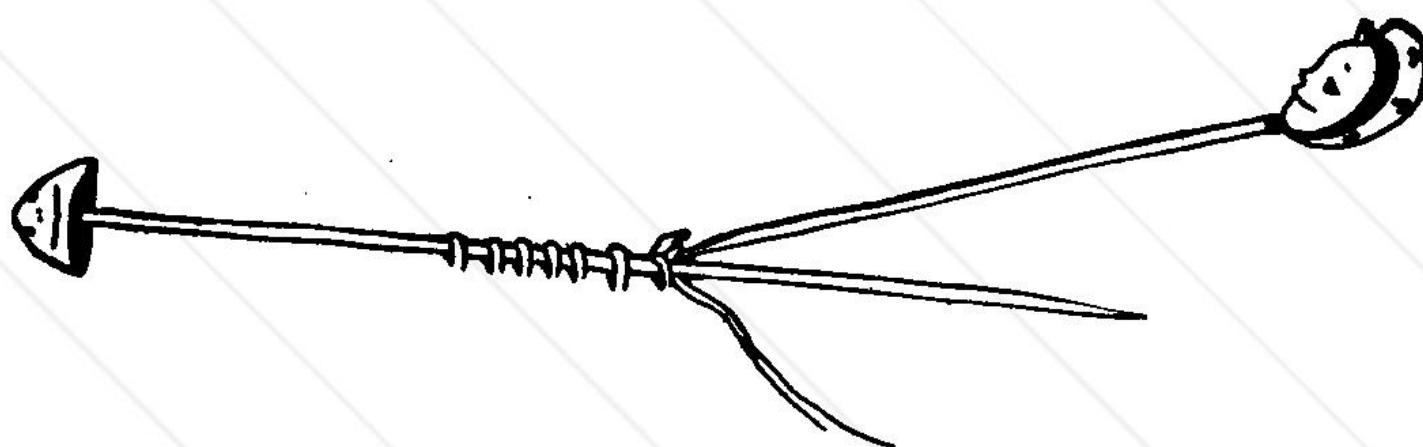

With crochet hook.

"She got the knack of that very quickly," said the Yarn Baby to Wooley Ball.

"No wonder," whispered Crow Shay. "I was there to help her."

"Many people would find the crochet method easier than other methods, but it is not to be preferred where the edges of garments must be stretched," Fairly Flew went on to explain. "It is not a good method to use in setting up the bottom of a sweater, because the edge should be very elastic; but if you are making a doll's shawl, for instance, the crocheted cast-on stitches would be all right."



"I was there
to help."

"See that, Knit and Knack!
You thought Crow Shay
Wouldn't be needed
For many a day!"

Crow Shay whispered to the knitting needle twins, who only laughed at him and clicked their heads together.

"Isn't he funny?" said Knit.

"Isn't he funny?" said Knack.

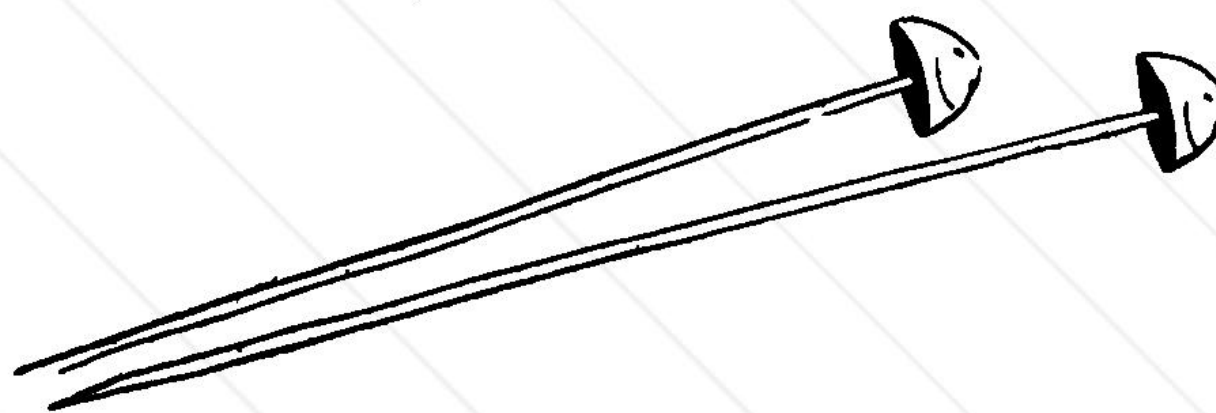

"Isn't he funny?"

"Funny Sonny
Cried on Monday,
Played on Tuesday,
Knit on Wednesday,
Crowed on Thursday,
Shayed on Friday,
Smiled on Saturday,
Laughed on Sunday,"

recited Crow Shay to them in a low voice.

"Say it out loud," said Fairly Flew.

Crow Shay looked embarrassed, but he knew that he must do as the fairy told him, so he repeated the lines, which set everyone laughing.

"He's so full of mischief," said Fairly Flew, "that sometimes he doesn't know what he is saying."

Crow Shay began to look very solemn and wise, which made them all laugh again; but they stopped very suddenly as Billy's voice called:

"Mary Frances!"

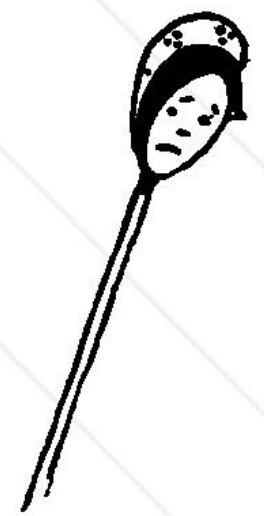

Looked
embarrassed.



"Say it out loud."



"I know what you wish to do"



GOODNESS, Billy, you made me jump!" exclaimed Mary Frances, running downstairs to meet him.

"Sorry," said Billy. "I couldn't find you down here and guessed that you'd be in the sewing room. What keeps you there so long?"

"Oh, I told you, Billy—I am practicing knitting!" Mary Frances replied.

"Well, it must be lots of fun," Billy said. "It certainly keeps you quiet enough. Come on, and have a game of tennis."

Mary Frances went to find her hat and jacket.

"When I know how, I shall make myself a sweater," she thought. "I should like to make one for

[159]



"You made me jump!"

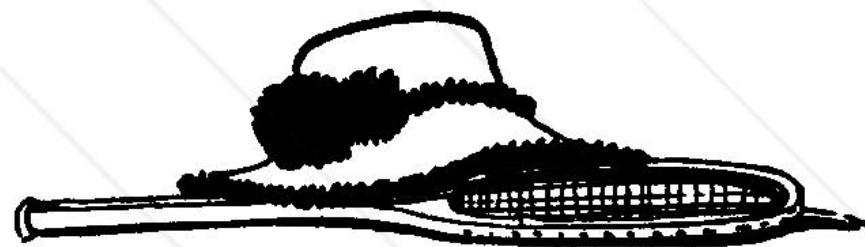

To find her hat.

mother first though—a pink one trimmed with gray.”

“Come on, Mary Frances,” called Billy, “aren’t you ready?”

“Coming,” cried Mary Frances, running out the door.

In about an hour and a half she came back to the room. “Oh, I have been so worried!” she exclaimed. “Dear Knitting and Crocheting People, I forgot entirely to give Mary Marie her bottle.”

“I gave her her pacifier,” said Crow Shay.

“Oh, what a story!” cried Knit.

“Oh, what a story!” cried Knack.

“I am glad that he didn’t,” said Mary Frances.

“I do not often let her have it for fear it will spoil the shape of her pretty mouth. I must run and give her her bottle now.”

“I thought the little Miss was joking,” Crow Shay said as soon as she had gone. “I never heard of a baby taking a bottle if she was old enough to go to school, did you?”



“Did
you?”

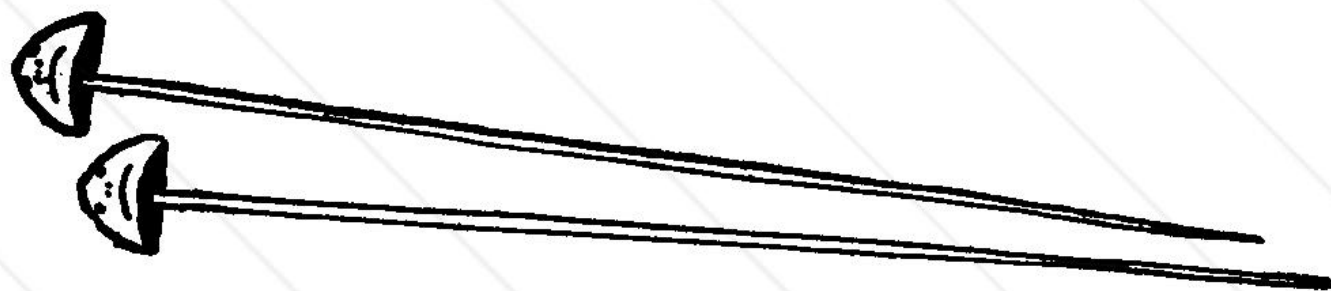

“Oh, what a story!”

"Oh, keep still, Crow Shay," whispered the Yarn Baby. "You know all about it. You know that Mary Marie is only——"

Just then Mary Frances came back.

"Mary Marie was sound asleep," she said, "so I didn't disturb her. Now I'll work hard to learn the next lesson," and she repeated the little verse,

"Fairy Fairly Flew,
Please come, for I need you;"

and the fairy appeared.

"I've been waiting to be called," she said setting quickly in the doll's rocker, "for you have such an important lesson to learn. Quickly set up fifteen stitches on one knitting needle."

"Which method shall I use?" thought Mary Frances, picking up Knack. "I believe I will use the first one I learned," she decided, and soon had the fifteen stitches ready. She broke off the short end of yarn which was hanging from the needle.

"Now," said Fairly Flew, "now, you are ready to learn how—"



"I've been waiting."



"Keep still, Crow Shay."

TO KNIT PLAIN

Material: Knitting worsted or four-fold Germantown zephyr in any color.

One pair bone knitting needles, No. 6, 7, or 8.

With the fingers, cast about 15 stitches on one needle. Tie the short end of yarn to the long end in a single knot close to the needle. Cut off short end.

CUT 1

Take up the other knitting needle with the thumb and fingers of the right hand, and slip the point of the right-hand knitting needle into the first loop on the left-hand needle, holding work in the position shown in the picture. Let the point of the right-hand needle stick out beyond the loop about an inch.

CUT 2

Now spread open the thumb and finger of the right hand, and slide the hand forward until you can lift the thread which is over your first finger over the point of the right needle.

"No, you'll
knot!"

CUT 3

Now slide the right hand back into the position shown in this picture, and put the first finger of your *left* hand on the point of the right-hand needle, and push the right-hand needle back until the point is even with the left needle.

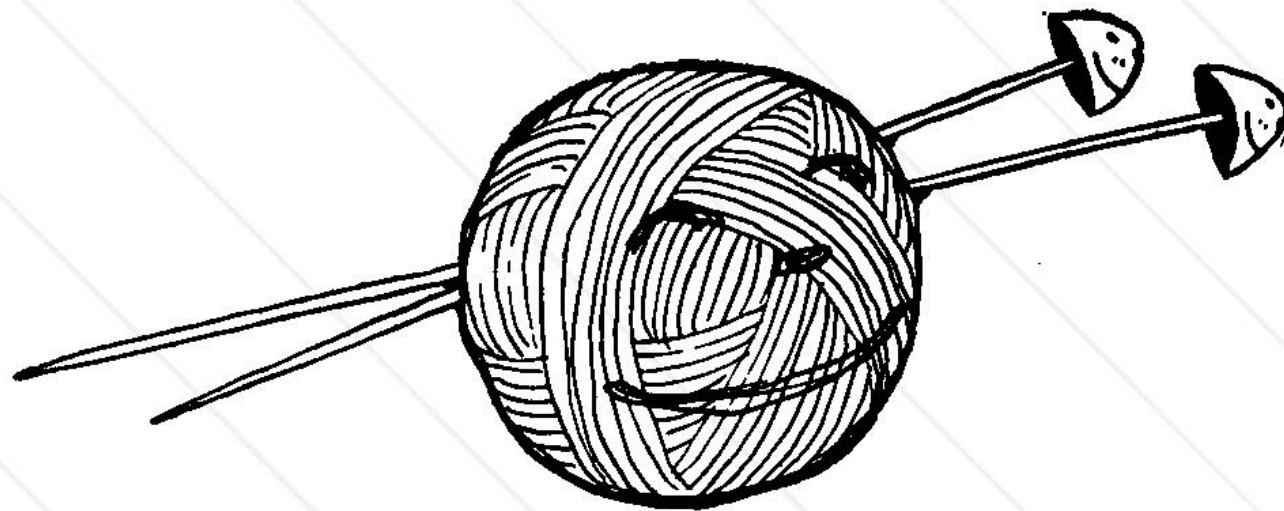

"We'll knit!"

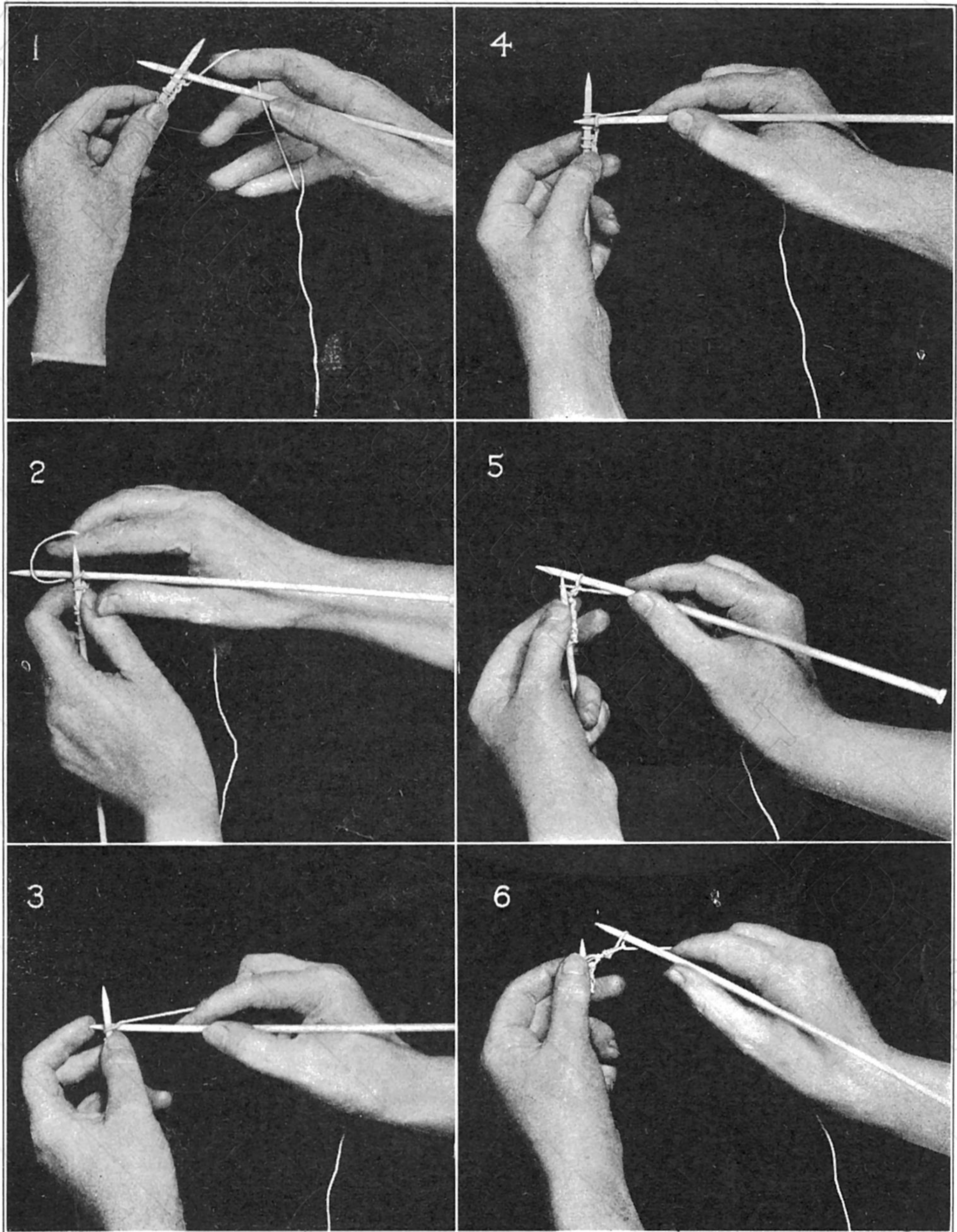

PLATE 7—MOTION PICTURES SHOWING HOW TO KNIT PLAIN
SEE DESCRIPTION, PAGE 162

Antique Pattern Library

TO KNIT A STITCH

163

CUT 4

Bring the point of the right-hand needle over the front of the left-hand needle. This carries a new loop on to the right-hand needle.

CUT 5

Slide the right-hand needle to the point of the left needle.

CUT 6

Slip the end loop on the left needle off the point of the left needle, holding back the other loops on the left needle with the finger and thumb.

Continue to knit in this way until all the stitches are knitted off the left needle.

Now place the needle with the new stitches on, in the left hand. Do not knit the first stitch off the needle, but slip it off the needle without knitting. Always slip the first stitch on a row unless told to do otherwise.

TO SLIP A STITCH

Put the point of the right-hand needle through the first stitch, and slip it over the top of the left needle.

Continue to knit plain across the row.



"See me
knit!"



"Don't brag!"



She drew up the strings



MARY FRANCES had so much trouble getting the knack of this lesson that her fingers seemed like "all thumbs," try as she would.

"You are a little nervous, my dear," said Fairly Flew. "Do not get discouraged. Some day you will laugh at yourself for having trouble in doing this, because knitting will be as easy—what is very easy?" she asked.

"Billy says, 'as easy as rolling out of bed,'" laughed Mary Frances.

"Well, 'as easy as rolling out of bed,'" finished the fairy. "You are nervous."

How Mary Frances wished that that time had

[165]

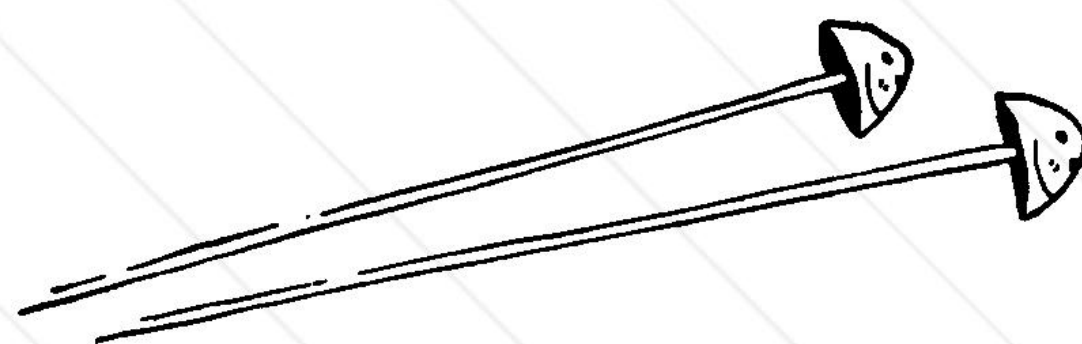

"Knitting will be easy."

come, or that the fairy would offer her her magic needles.

"I cannot offer you my magic needles you know," went on Fairly Flew; "but I can help you learn the lesson. Just watch me closely."

She pulled two tiny gold knitting needles from her pocket. The heads of the needles sparkled so that Mary Frances thought they must be diamonds.

Then the fairy drew some fine yarn from her pocket and began to do the lesson just as she had given the directions to Mary Frances.

"Now, watch me closely," she said, "and take your needles and do exactly as I do."

Before Mary Frances realized it, she had fifteen nice rows of knitting done.

"Isn't that splendid!" exclaimed Fairly Flew. "Now you are ready to learn—"

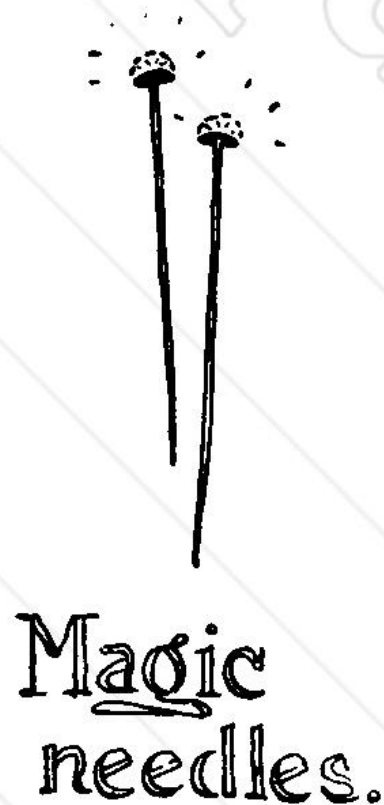

Magic
needles.

HOW TO BIND OFF

(How to Finish Knitted Work)

NOTE.—When first learning how to bind off work it is easier to use a crochet hook in the right hand in place of the knitting needle, as shown in the picture on page 167.



"Isn't that splendid!"

In doing this work make very loose stitches.

1. Knit the first 2 stitches of the last row of work on to a No. 4 crochet hook.
2. Slip the left needle into the first loop on the crochet hook and pull this stitch over the top of the hook, and over the stitch nearest the hook.

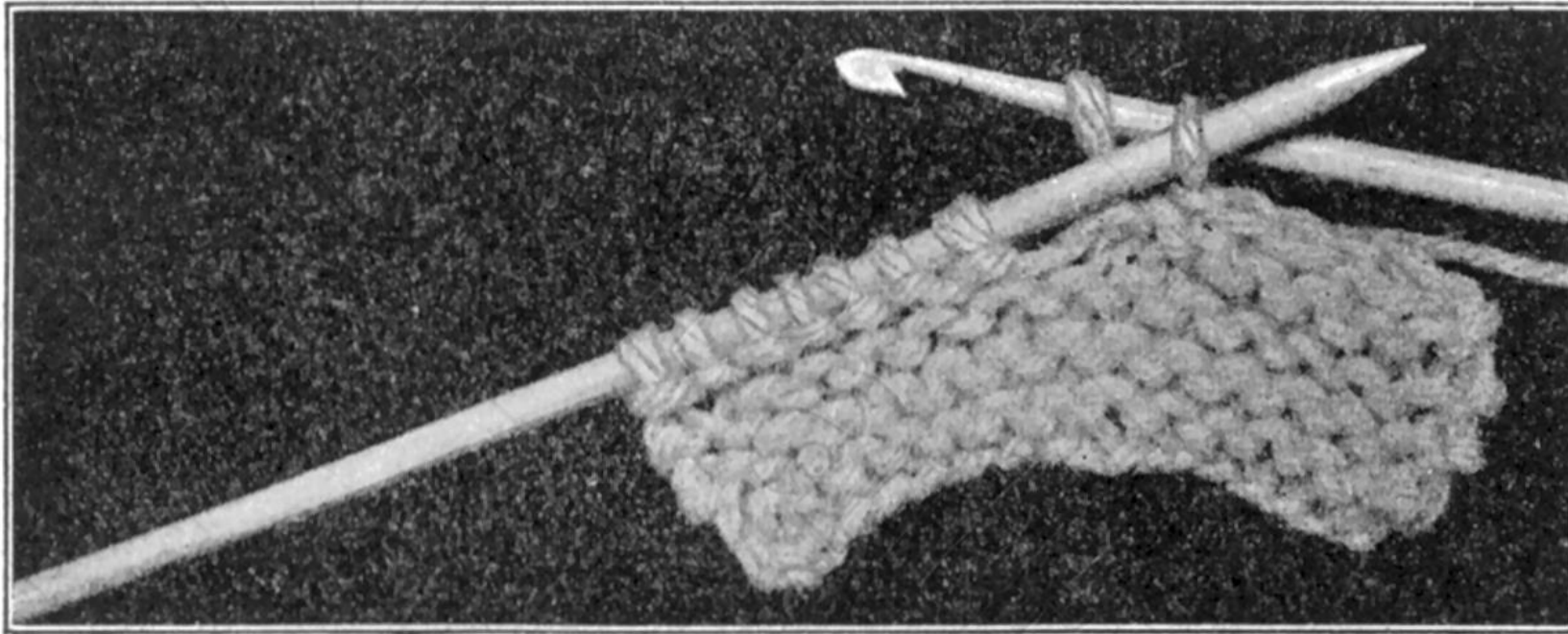

HOW TO BIND OFF

3. Knit another stitch, still using the crochet hook in place of the right-hand knitting needle.

4. With the left-hand needle lift the first loop on the crochet needle over the stitch just made and over the hook of the crochet needle.

5. Continue doing this until there is but one stitch on the crochet needle. Break off the yarn about 1 inch from the work, and pull it all the way through this last stitch.



"I helped!"



"Look at proud Crow Shay."

Of course, Mary Frances did not find it difficult to follow these directions, because she watched Fairly Flew do the work and made each stitch just as the fairy made it.

"That is splendidly done," said the fairy as Mary Frances broke off the yarn and fastened the last stitch. "For the next lesson you will make something for Mary Marie."

"Oh, I do not see how I can wait until to-morrow to start!" exclaimed Mary Frances.

"But you'd better not work any more now—besides, my time is up for to-day," said Fairly Flew. "It will not seem long until to-morrow, because you'll be asleep for all night, you know."

So Mary Frances put away her work.

"Good-bye, dear friends," she said as she went away.

"Good-bye. We'll all be ready and waiting to-morrow," everybody promised at once.



"Good bye."



OUR FRIENDS, TEDDY BEAR AND AIRMAN

FOR DIRECTIONS FOR MAKING KNITTED ARTICLES SHOWN IN THIS ILLUSTRATION SEE

TEDDY BEAR SUIT—129

DOLL'S BEAN BAG—180

AVIATOR DOLL'S OUTFIT—196-197

Antique Pattern Library



As soon as Mary Frances opened her eyes the next morning she thought of the promised lesson.

"I'll hurry and dress," she whispered. "Perhaps I can start my lesson before breakfast. I wonder if the Knitting People are awake yet?"

Soon she was dressed, and ran to the sewing room.

"Good morning," everybody greeted her as she entered.

This surprised her quite a little.

"Why, good morning, my dear friends," she replied. "I thought maybe you wouldn't be awake yet. It is so early."



[169]

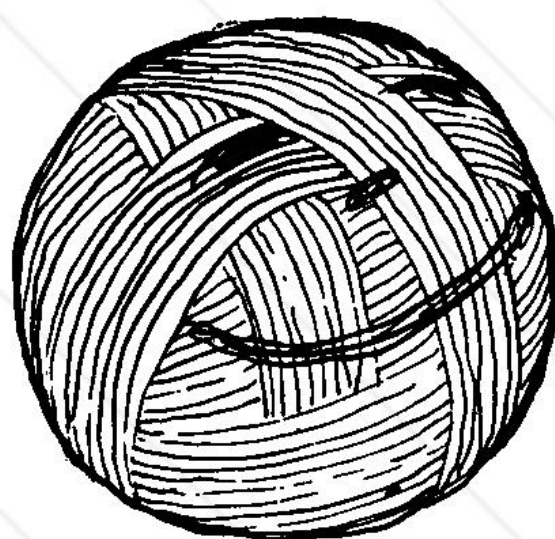

"Good morning."

“Give me a shake
If I’m not awake
Before anyone else
Jumps into the cake,”

sang Crow Shay.

“Jumps into the cake!” exclaimed Mary Frances.

“Why, what has that to do with your waking up?”

“Oh, nothing,” answered Crow Shay, “only I couldn’t think of any other word to rhyme.”

Then Mary Frances laughed and said the little magic verse,

“Fairy Fairly Flew,
Please come, for I need you.”

“Give me
a shake.”

“Good morning,” Fairly Flew said; and before Mary Frances could reply, she added, “How pleased we are to see you so bright and early because you are so anxious to learn your lesson.”

“And because I am so anxious to make something for my dolly,” said Mary Frances.

“Well, you may start right away,” and Fairly Flew began to give the instructions for making—



“Jumps into the cake!”

DOLL'S KNITTED SHAWL

(See picture opposite page 72—color plate)

Material: Four-fold pink Germantown zephyr.

Needles: one pair No. 5 knitting needles, one crochet hook No. 3.

1. Cast on 23 stitches Knit plain until shawl is 14 inches long; and bind off.

2. Trim ends with fringe, cutting the strands of yarn each 4 inches long. Put 2 strands in every other stitch at ends of shawl and pull through with crochet hook. (See directions for making fringe, page 69.)



Mary Frances set to work with great pleasure, and before Katie called her to breakfast she had eight rows of knitting done.

After helping Katie to dry the breakfast dishes, she sat in the hammock and did six more rows.

“Won’t Fairly Flew be surprised when she sees this!” she thought as she started upstairs.

The fairy was waiting in the little rocker when she entered the room.

Waiting
for her.



Katie called her.

“Oh!” she exclaimed, “isn’t that lovely! You have done some work all by yourself.”

“Yes,” said Mary Frances, “I wanted to surprise you, but somehow it seems to me that the rows I have just knitted do not look quite so even as those I did when I was with you.”

“Let me look at them more closely,” said the fairy, and when Mary Frances laid her work on the table she bent close over it.

“Oh, my dear!” she said in her tiny voice. “Oh, my dear, you have dropped some stitches! See?” and she pointed to the loose threads.

Mary Frances picked up her work and stretched these places open. The stitches ripped apart.

“My, I am so disappointed!” she exclaimed. “What shall I do?”

“You must pull out your needle and rip out all your stitches back to the beginning of the row where you see your first mistake,” said the fairy.

Try as she would, Mary Frances couldn’t keep the tears from coming to her eyes as she ripped out the stitches which she had made with so much pleasure.



You dropped some stitches



Couldn't keep back the tears.

"Oh, see how wrinkled the yarn is!" she cried. "I guess it will look awful when it is used again!"

"No," said the fairy, "it will not. Why, many a grown person has unraveled a whole sweater and used the yarn again."

"I shouldn't think used yarn would make anything very nice," said Mary Frances.

"Yes, it does, if it is steamed."

"Why, how can it be steamed?" asked the little girl, wondering.

"To steam the crinkles out of used yarn, lay it in a towel. Place the towel in a wire strainer or colander. Place the strainer for five minutes over a kettle of boiling water, but not touching the water. Let the yarn dry in the strainer with the towel open." "Can it be steamed?"

"Isn't that fine to know!" said Mary Frances. "Shall I go steam this?" She held up the pink yarn.

"No," replied the fairy. "That has been ripped so soon after making that you will not have any trouble with it. Try, and see."

So Mary Frances started bravely to work again. When she had done the seven rows which she had ripped out Fairly Flew said, "How well you have

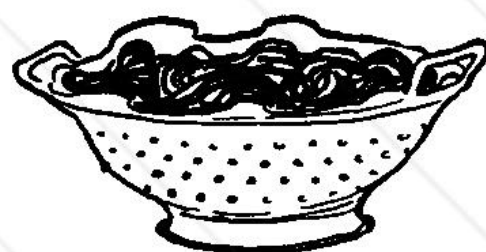

"Place in a colander."

done, little girl! Now, you may finish the shawl with my magic needles."

You can imagine, can't you, just how pleased Mary Frances was when the fairy's golden diamond-headed needles finished the shawl in a minute?

All this time Crow Shay had watched with sparkling eyes everything that happened.

Fairly Flew now turned to him and said, "You have been so very good, Crow Shay, that you may make the fringe on this shawl."

Mary Frances couldn't help laughing to see the little fellow tumble head foremost into the little shawl and kick the fringe on the ends in less time than it would take to tell you how to do it.'

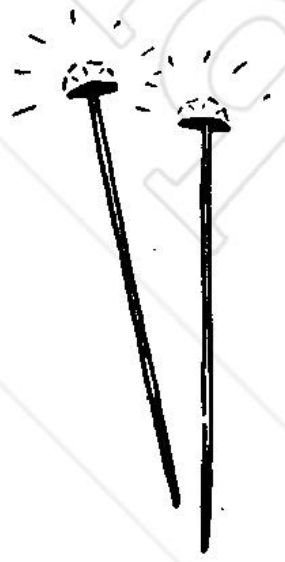

Diamond
headed.

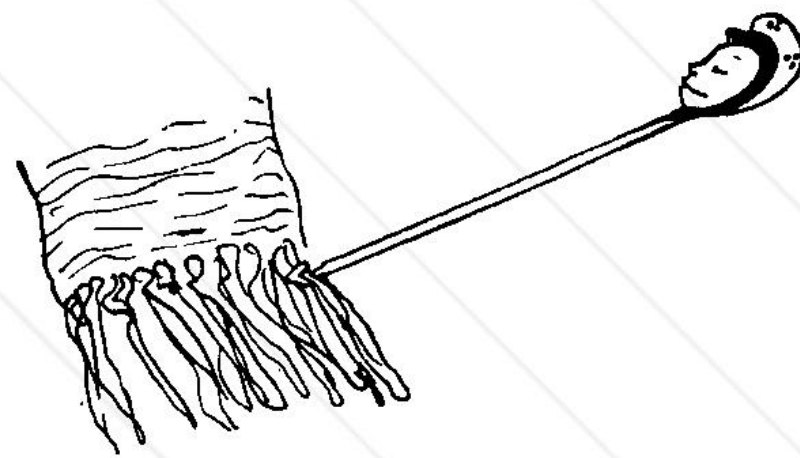

Kick the fringe.



“SOVELY s’awl,” laughed the pleased dolly, when Mary Frances tried the little shawl on Mary Marie. “Nice warm st’etchy shawl,” as she wrapped it close over her shoulders. She meant stretchy, you know.

Mary Frances carried her into the sewing room, “to thank her kind friends who taught her mamma to make it,” which pleased them all very much.

When Mary Frances started to take the shawl off, Mary Marie cried, “’Oo tan’t hab my s’awl; I’ll be told,” so Mary Frances sat her on the table with the shawl around her, and gave her her doll to play with.

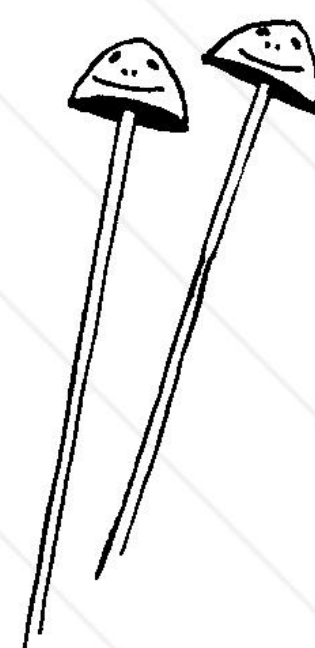

To thank them.

“Mary M’rie needs a nice ’ittle bonnet, to wear wif

[175]



“Nice warm st’etchy shawl.”

'iss s'awl," said Mary Marie, looking up after a minute. "Mary M'rie's ears are told."

"I will go get your little cap," said Mary Frances, starting to go find it.

"No, no, Mamma," cried the doll-baby. "Don't want tap. I want bonnet. Teep ears warm," and she began to rub her little ears.

Mary Frances laughed. "You can pull your cap down on your ears, dearie," she said.

"No," said Fairly Flew, "what Mary Marie wants is a real little bonnet, just as she says—one that will tie under her chin and cover her ears. Yarn Baby has just been waiting to give you the rules for making—

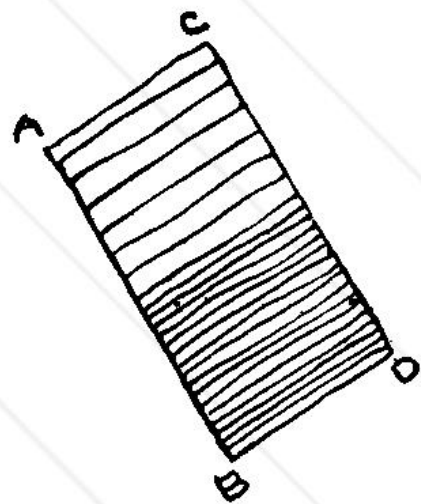

Sew A-C
and B-D

DOLL'S KNITTED HOOD

(See picture opposite page 230—color plate)

Materials: Two-fold pink and two-fold white Saxony wool.

One pair knitting needles, No. 2.

Directions:

1. Cast on 55 stitches with pink wool.
2. Knit plain for $4\frac{1}{2}$ inches.
3. Break off pink wool and tie on the white wool, and knit $4\frac{1}{2}$ inches. Bind off the work.

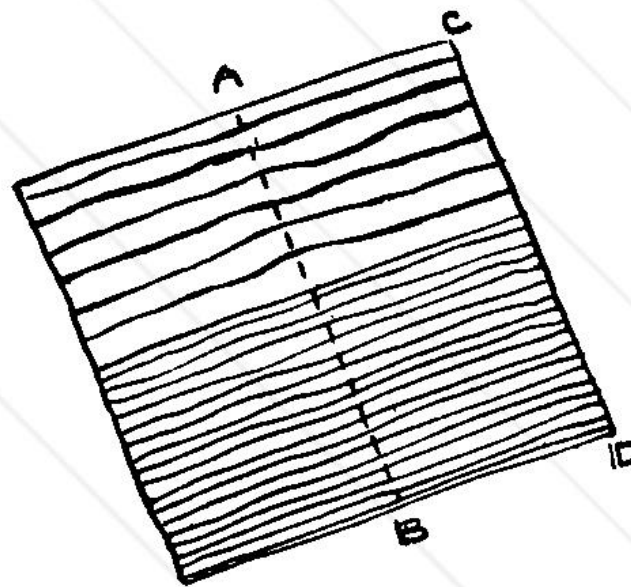

Fold on A-B

DOLL'S KNITTED HOOD

177

To Form the Hood

1. Fold the strip together across the two colors along the line *a* and *b*.
2. Sew (overhand) with Saxony wool along edges *a c* and *b d*.
3. Turn inside out to put seams on the inside.
4. Now fold on the line where the two colors are joined, and overhand the colors together on the open edge.
5. Thread a long-eyed needle with three-quarter yard narrow pink ribbon and sew with small basting stitches along the edge just overhanded—to use to tie cap.
6. Fasten ribbon rosettes on each corner for trimming.

Fairly Flew's magic needles lay on the table, but Mary Frances did not like to use them without the fairy's special permission. So she took Knit and Knack up in her hand, and they did their very best to help her, sliding into the stitches almost by themselves.

In fact, they did so well that it did not take Mary Frances long to finish the little cap.

"Isn't that boo'ful!" exclaimed Mary Marie, clapping her hands as Mary Frances held it up to view. "Pit it on, Mamma. Please pit it on Mary M'rie!"

"Wait until I put on the strings, dear," said



Cap finished.

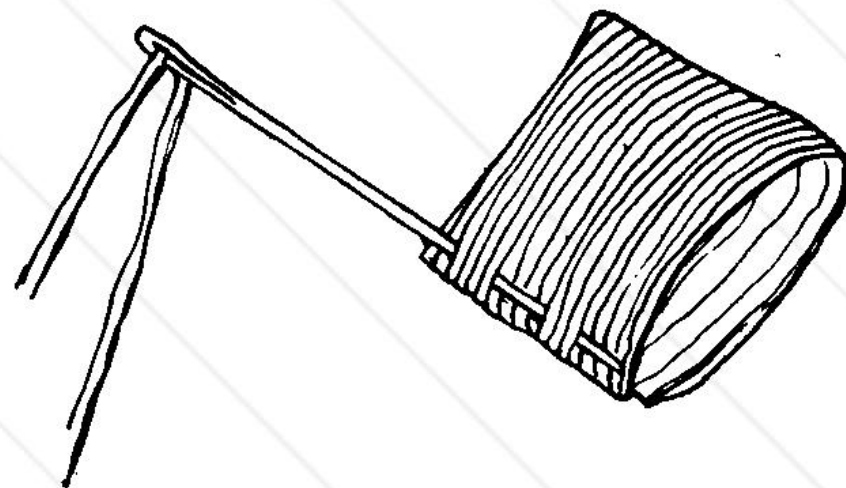

to tie cap.

Mary Frances. "I have just the right kind of ribbon in my little doll's trunk." And she went to find it.

Very soon Mary Marie had on the beautiful soft warm hood.

"Oh, doesn't she look sweet in that?" exclaimed Mary Frances, kissing her.

"Ears nice and warm, Mamma. Mary M'rie s'eeepy now." And Mary Frances carried her off to bed.

"T'ank 'oo all, berry much," said Mary Marie, throwing kisses, as Mary Frances stopped in the doorway for a minute.



Right kind
of ribbon.



"T'ank 'oo all."

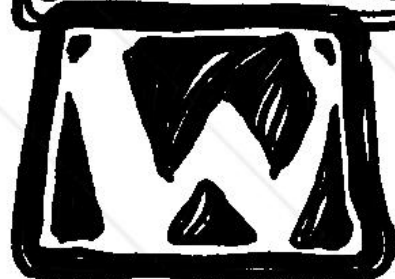

WHEN Mary Frances came back, Crow Shay asked her a question.

"Little Miss," he said, "what's a purl?"

"A pearl?" said Mary Frances, greatly puzzled by his asking such a question. "A pearl is a precious stone found in oysters."

"Oh, no; I beg your pardon," said Crow Shay. "A purl is a precious stitch found in knitting."

"Is he crazy?" Mary Frances wondered.

"No," laughed the fairy, "he isn't crazy. He is right about this; it is now time that you learn how to make ribbed work in knitting. This is called purling. How would you like to learn to purl and, at the same time, make a bean bag for Mary Marie?"



"What's a purl?"

[179]



"No, he isn't crazy."

“Oh, that would be splendid!” cried Mary Frances, very much pleased.

“All right, then,” said the Yarn Baby; “listen carefully, and you will find out how to make a

DOLL'S KNITTED BEAN BAG

(See picture opposite page 168—color plate)

Material: Four-fold red, white, and blue Germantown zephyr.
Two steel knitting needles, No. 12.
Bone crochet hook, No. 3.



Directions:

1. With red yarn, cast on 12 stitches.
2. Knit 1 row across.
3. The next row will be purl. Slip off the first stitch without knitting.

Doll's
Bean Bag.

How to Purl

CUT 1

Throw the yarn in front of the *right-hand* needle by throwing it over the point of the needle just as if taking a knitting stitch, but do not put the point of the needle into any stitch on the *left-hand* needle before throwing the yarn over the point of the *right-hand* needle.



“Listen carefully.”

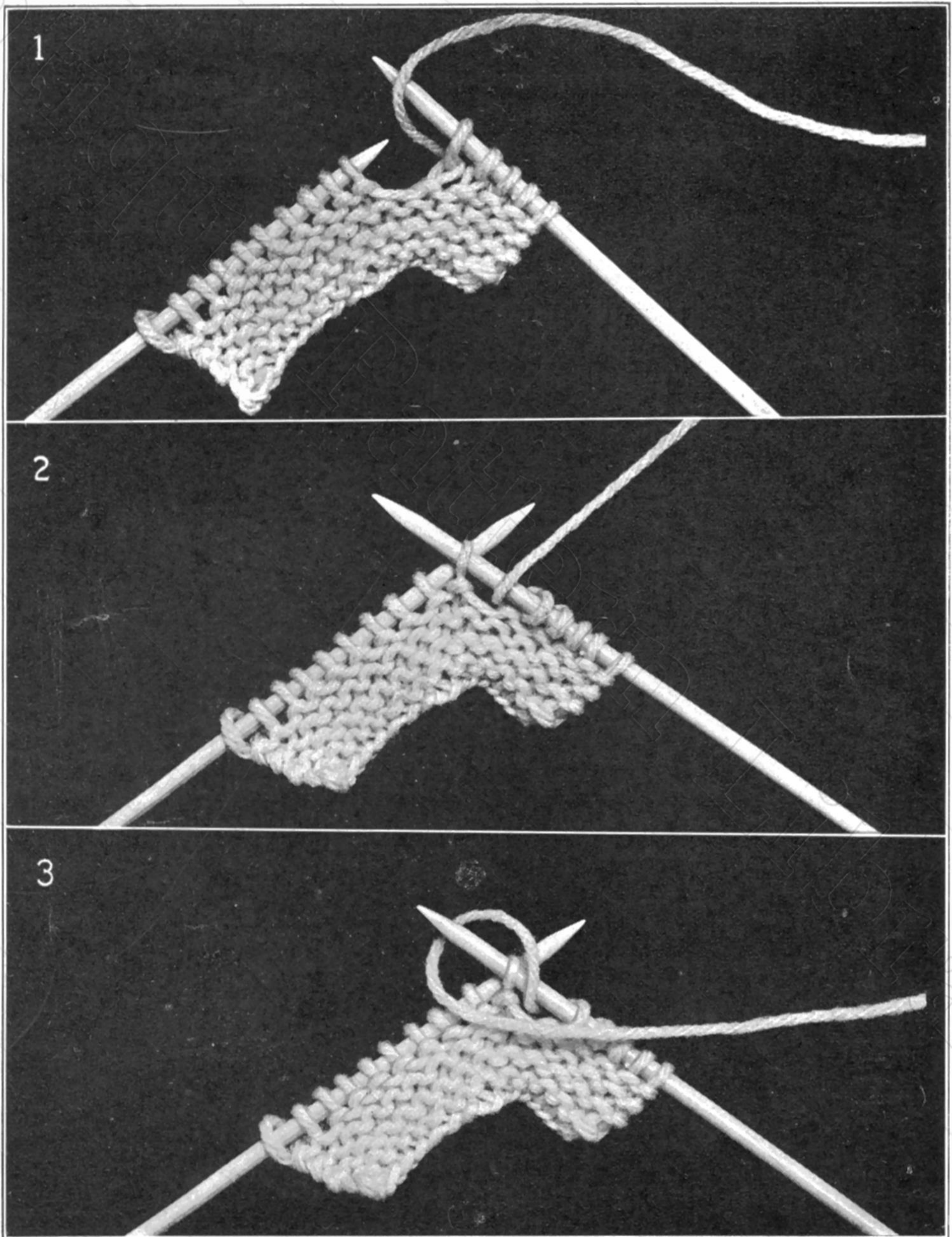

PLATE 8—HOW TO PURL. SEE DESCRIPTION, PAGE 180

Antique Pattern Library

WHAT'S A PURL?

181

CUT 2

Now put the point of the right needle into the next stitch on the left needle pointing the right needle toward the base of the left thumb.

CUT 3

Throw the yarn over the point of the right needle in just the same way as in plain knitting.

Next, pull the right needle *back* and slip it *under* the left needle. Slip the top stitch on the left needle off the point of the left needle. The yarn will then be in the right position for purling the next stitch.

Continue to purl all the way across the row.

4. Slip off the first stitch and plain knit off the other stitches in the next row.

By this time you will notice that when you are purling you are doing the work on the wrong side.

5. Slip off the first stitch on the next row. After slipping off this stitch, throw the yarn in front of the right needle and purl across the row.

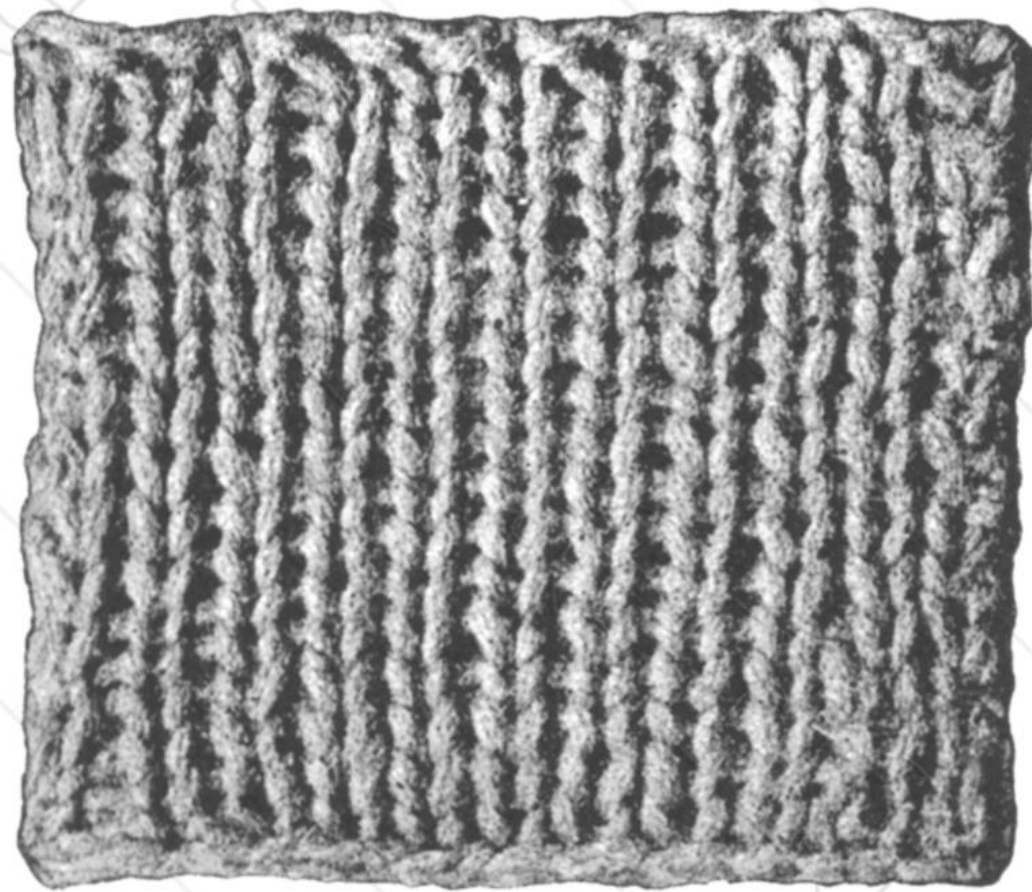

Beneath
stitch.

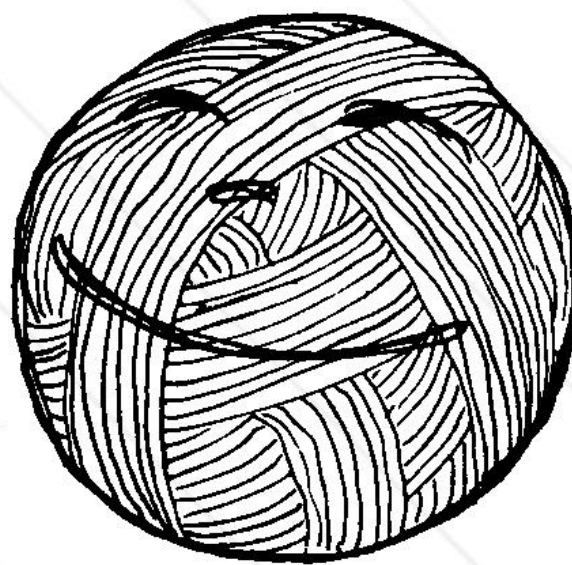

"Isn't it pretty?"

6. Continue knitting and purling every other row until the piece of work is 2 inches long. Bind off. This forms one side of the bean bag.

7. Make another piece like this for the other side, using the blue yarn.

To Make the Bean Bag

1. Make a little bag of soft cotton cloth and partly fill it with rice.

2. Lay the red and blue pieces together, backs facing each other and "ribs" running in the same direction.

3. With the white yarn, crochet the edges together with single crochet, leaving one end open. Slip the cloth bag inside the knitted bag and finish crocheting it together.

Mary Frances found that purling seemed quite awkward to do at first, but after she had done half a dozen rows, the stitches formed much more easily. When she finished the red square she stopped to admire the pretty even rows of ribs. Just as she finished putting the bean bag together, the bell rang for luncheon.

"I'll bring the rice back with me after lunch," she said, "if Katie will give it to me."



Rice.

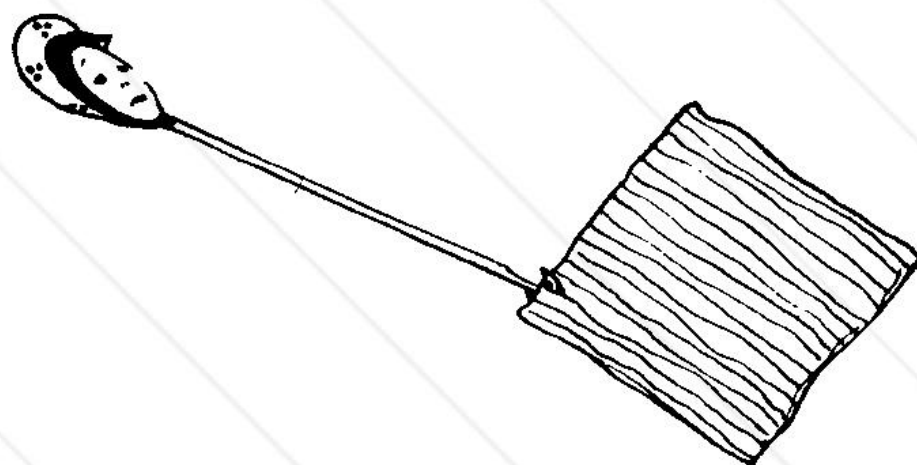

Crochet edges together.

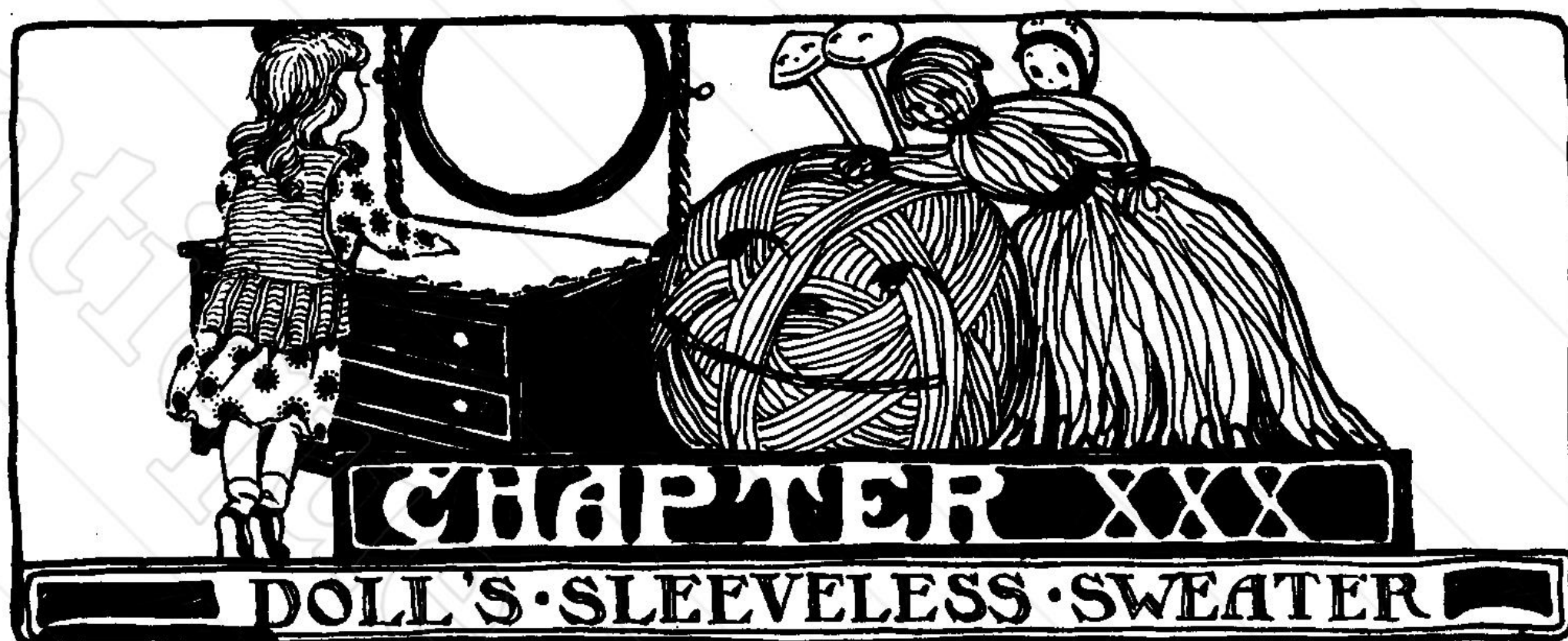

WHEN she came back, Mary Frances had the rice; and she soon finished the little bean bag.

"Won't Mary Marie be delighted with this surprise?" she said. "I feel almost like waking her up."

"Oh, don't do that," said Fairly Flew, "because we will soon have another surprise for her if you will work hard."

"Indeed I will," promised Mary Frances. "I wonder what it is?"

"Guess!" said Crow Shay.

"A—a wash rag?" guessed Mary Frances.

"No," said Fairly Flew. "Guess again."

"A—a stocking?" guessed Mary Frances again.

[183]



"Another surprise."

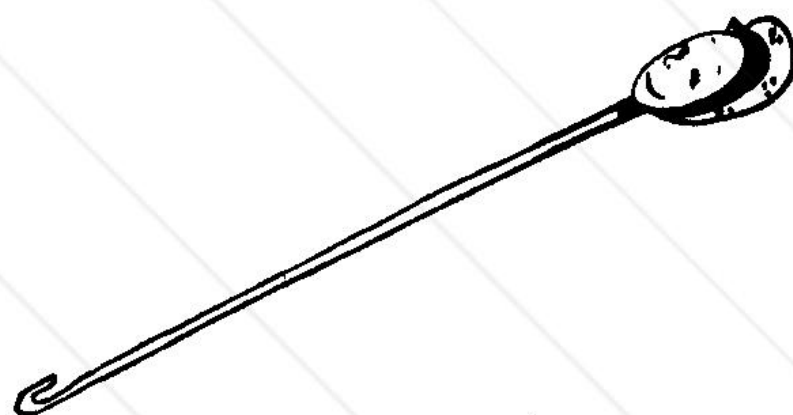

"Guess!"

“Oh, no.” laughed Crow Shay,

“It’s something better—
It’s a sweater.”

“Is it?” cried Mary Frances. “Is it? Why, that’s just exactly what I’d wish for most of all things!”

“It is,” answered Fairly Flew, “and this time Wooley Ball is going to give the directions.”

“Oh, I am so glad!” exclaimed Mary Frances. “I have wondered and wondered why she is so quiet.”

Everybody looked at Crow Shay. Crow Shay looked ashamed.

“I’ll tell you about it,” he said at length. “You see, I talked so much that Wooley Ball made a bargain with me. She said that if I would talk only half that I wanted to, she wouldn’t talk at all, and we’ve both kept our bargain.”

Then everybody began to laugh. Wooley Ball laughed most heartily of all.

“You see, it isn’t hard for me to keep the bargain,” she said, “because, while I like to tell about yarns,



“It’s a
sweater.”

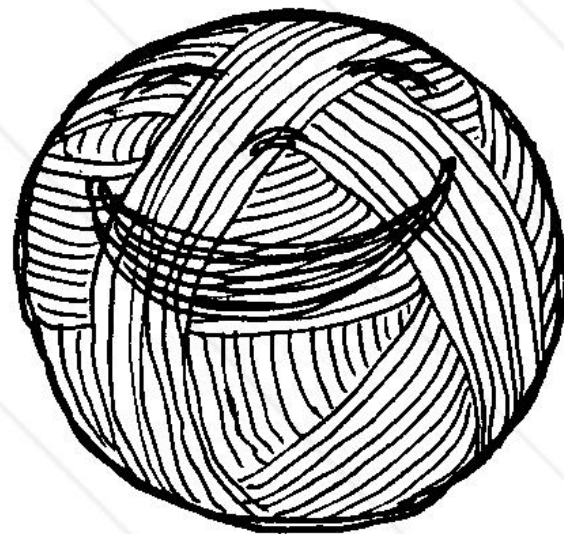

Wooley Ball laughed.

DOLL'S SLEEVELESS SWEATER

185

I'm not much of a yarn spinner. Still, if our Fairly Flew wishes, I shall feel honored to tell how to make—

DOLL'S KNITTED SLEEVELESS SWEATER
(See frontispiece—color plate)

Material: Turquoise blue double wool floss, and gray teazle yarn for trimming.

2 Bone knitting needles No. 3, crochet hook No. 3.

Directions:

To Knit the Back of the Sweater

1. Cast on 32 stitches and knit plain for 15 ribs. A rib is made by knitting a row across and a row back again. Two rows form a rib in knitting.

2. To form the waist line, knit 2 stitches and purl 2 stitches for 6 rows.

3. Knit 15 more ribs plain. This will reach the shoulder of the sweater.

4. *To Knit the Shoulder.*—Knit 10 stitches, and slip them off on a safety pin. (See page 186.)

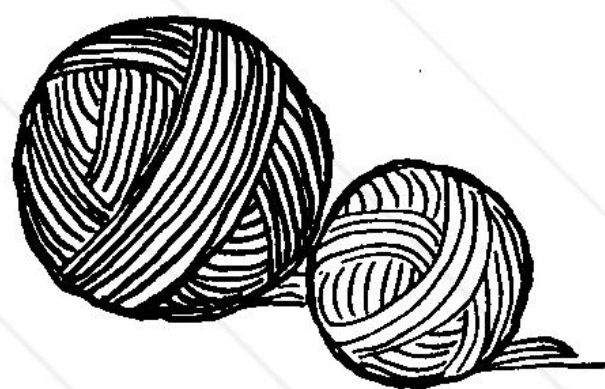
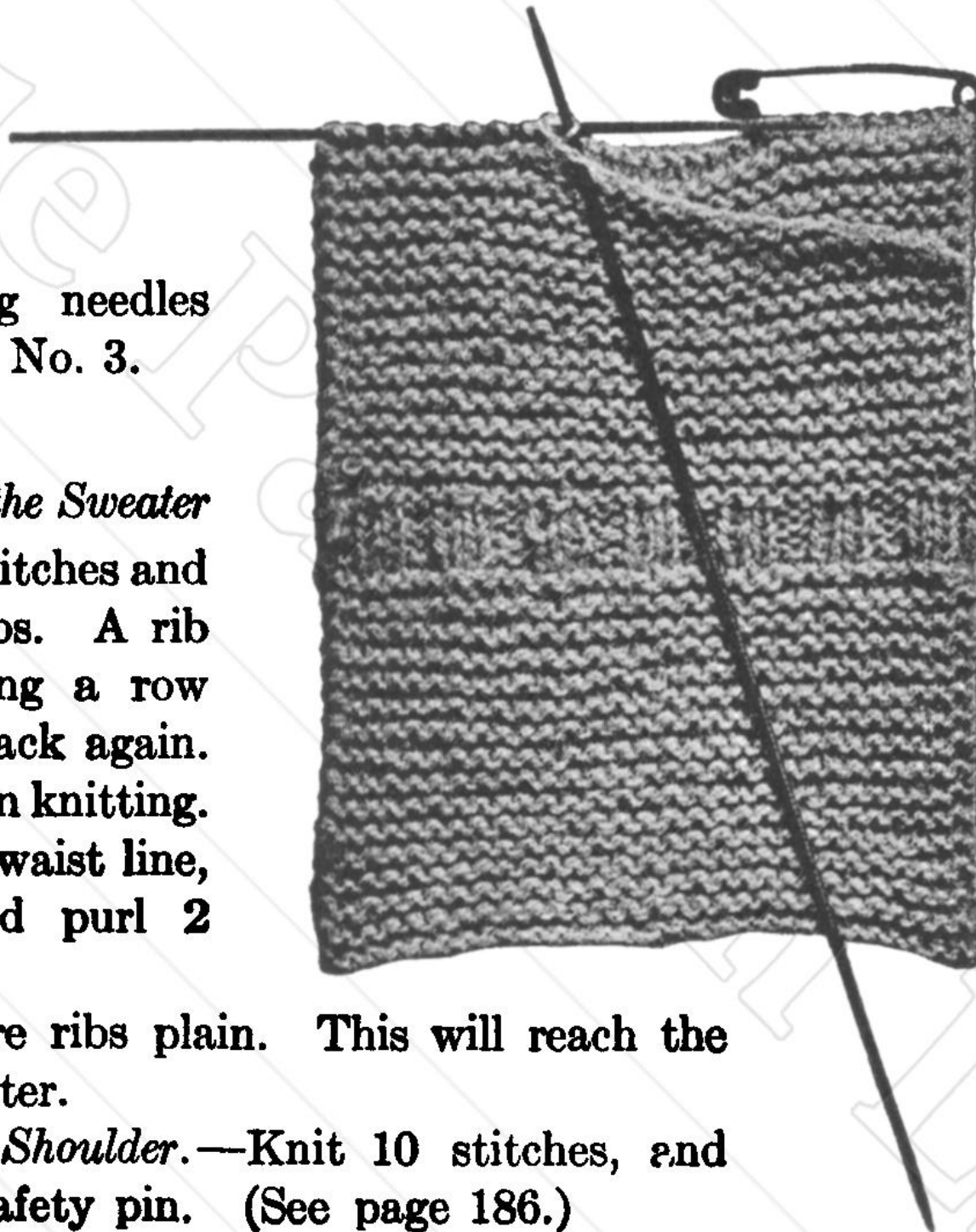

Blue floss and gray yarn.

To Slip off Stitches Needed Later

(See picture on page 185)

In doing this work, point the safety-pin toward the last stitch on the right-hand needle, and slip it off the needle on to the pin. Slip the rest of the stitches in the same way. Clasp the safety-pin. Very large safety-pins are made for the purpose.

5. Bind off the next 12 stitches to form back of neck.

6. Knit 4 ribs on the remaining 10 stitches to form the shoulders. (See picture on page 187.)

7. Now increase the number of stitches. Make 1 new stitch on every other rib (that is, on one row of every other rib). Add the extra stitch to the neck end of front of sweater.

To Increase or Add a Stitch in Knitting

Knit 1 stitch on the front thread of 1 stitch, and without slipping a stitch off the end of the left needle bring the right needle over the point of the left needle. Knit another stitch on the back thread of the same stitch. In doing this, point the needle through the back thread away from you. Slip top loop off left needle.

8. Increase the number of stitches as explained in No. 7 until you have 16 stitches on the knitting needle, and continue to knit in ribs without increasing until there are 20 ribs from the starting of the shoulder.

9. Then knit 2 and purl 2 stitches for 6 rows.

10. Then knit 15 ribs plain and bind off the work.

11. To start making the other shoulder, unclasp safety pin and hold knitting needle pointing toward point of safety pin.



Slip
stitch.



"Wont she be surprised?"

DOLL'S SLEEVELESS SWEATER

187

Take 1 stitch at a time off the safety pin on to the knitting needle. *Fasten the wool at corner of neck.*

Then make other front like the one just finished.

Sew fronts and back together along line a b, pinning a to a, and b to b. The space between a and a will form the armhole. (See frontispiece.)

To Make the Collar

(See page 188.)

1. With gray teazle yarn cast on 26 stitches, and knit 2 ribs.
2. Break off the gray yarn and tie on the blue yarn.
3. Knit 8 ribs of blue.
4. Knit 8 stitches. Slip them on to a safety pin.
5. Bind off 10 stitches for the neck, and on the other 8 stitches knit 11 ribs of blue. Break off yarn.
6. Join the gray yarn and knit 2 ribs. Bind off the work.
7. Take the 8 stitches off the safety pin on to the knitting needle and make the other side of the collar in the same way. Sew the collar to the sweater with blue yarn.

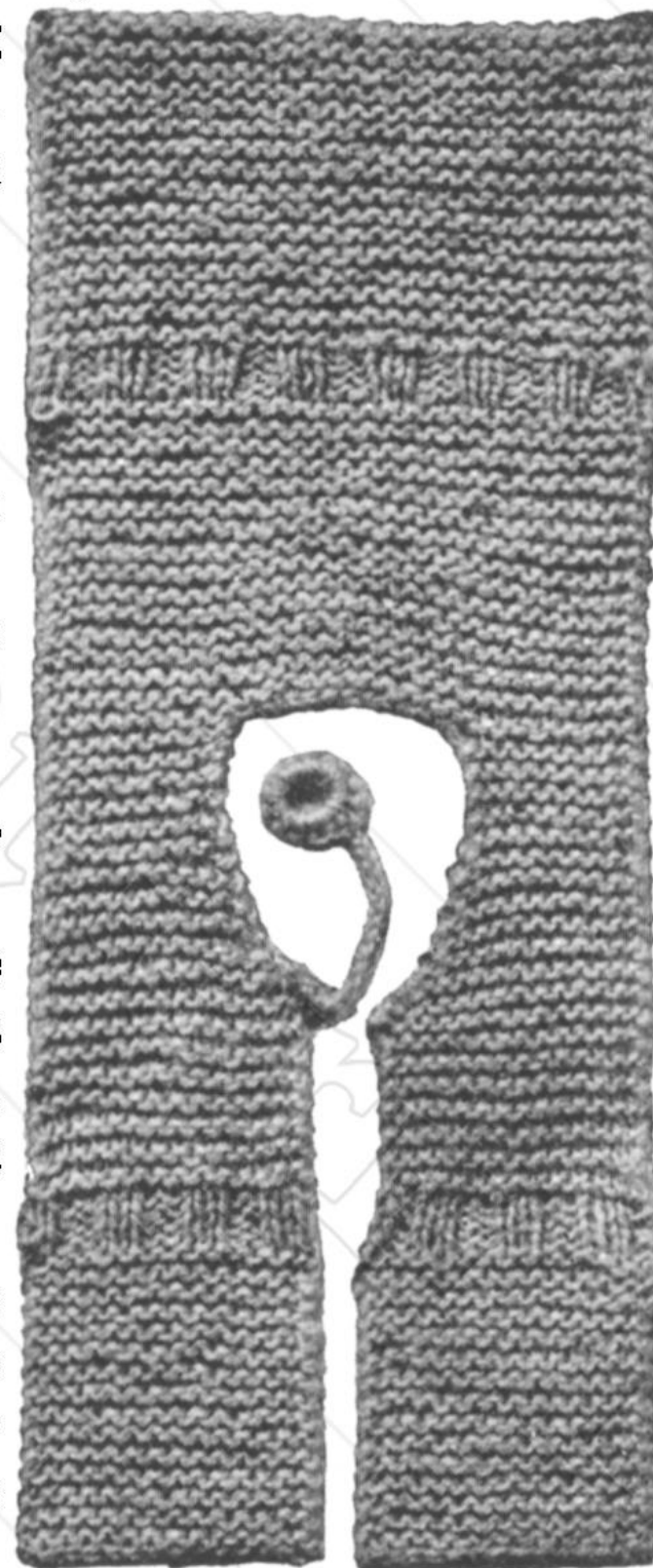

b

a

a

b



Slip on
safety
pin.



To form armhole.

To Make the Tie

Crochet 15 chain stitches and hang a tassel to the end for trimming; or instead of making a tassel, crochet single crochet

stitches over a little brass ring if you have one; or

Wind the yarn around a lead pencil 8 times. Without breaking the yarn slip the ring thus formed off the pencil. (See picture p. 189.)

(a) Tie it together with sewing thread.

(b) Make single crochet stitches over the ring until it is filled, and without breaking the yarn, make a chain of 15 stitches.



Sew the chain to the sweater at the end of the collar. Make another tie in this same way.



Wind on
lead pencil

When the beautiful little sweater was finished, with the help of the magic knitting needles, Mary Frances was too happy for words, and Mary Marie danced up and down with joy.

"'Et Mary M'rie see herse'f in the glass!" she begged. "Please, Mamma, 'et her loot at et!"



Danced with joy.

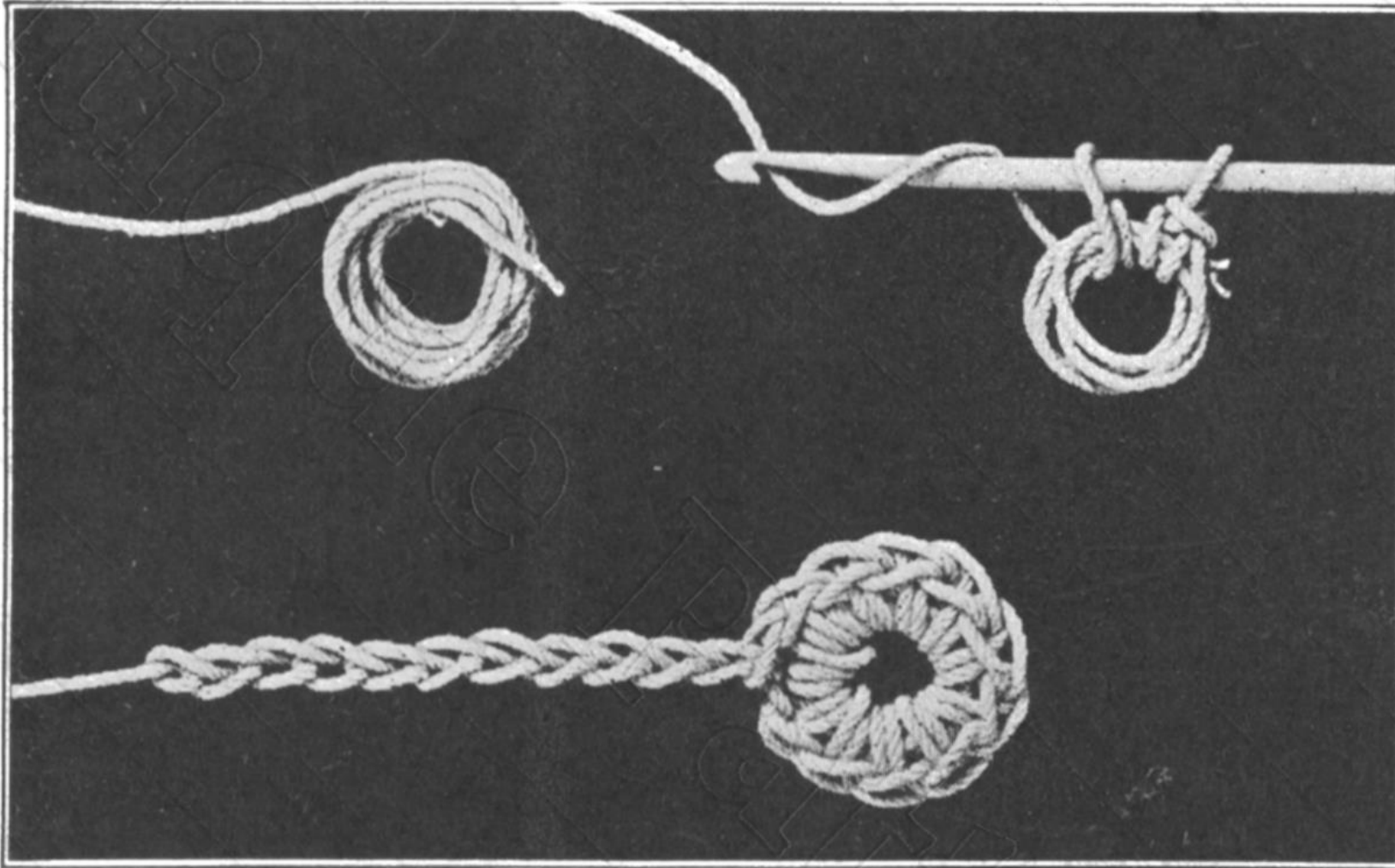

TO MAKE THE TIE

So Mary Frances stood her before the doll's bureau.

"Isn't I tweet?" said the proud doll-baby, "I mean, isn't it tweet?—I mean, isn't we tweet?" and set everyone laughing.

"Oh," exclaimed Mary Frances, looking out of the window, "here comes the postman. I hope he has a letter from mother." And she ran to the door.

Everyone
laughed.



"Isn't I tweet?"



"The very thing."



LISTEN! she said, coming back after a few moments. "Listen while I read my letter:

Dear Mary Frances:

How glad you will all be to hear that father is so much better that Aunt Maria and I are planning to bring him home some day next week.

What dear good children you and Billy have been, and how we have enjoyed your splendid cheerful letters.

I am pleased that you have been practicing on your crocheting lesson. It pleases Aunt Maria, too. Every girl should be able to crochet and knit. I wish I had been taught when I was little—but I had no Aunt Maria.



*Aunt
Maria.*

[191]

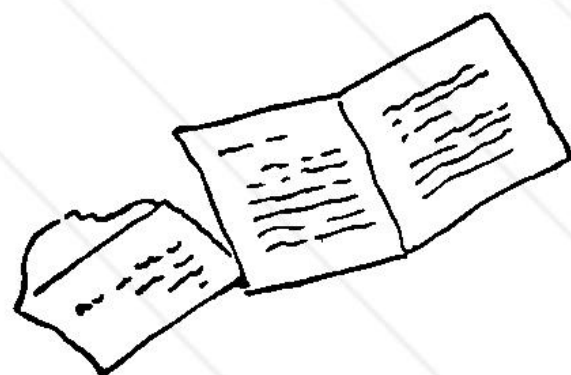

"Dear Mary Frances."

Now, my dear, be brave a little while longer and not too lonely, for the sake of your loving

Mother and Father.

"Now, isn't that a lovely letter!" said Mary Frances, as she finished reading.

"Lovely letter!" said Crow Shay. "Lovely letter, but it means a hurry-hurry to get through our lessons!"

Mary Frances looked at Fairly Flew.

"Yes," the fairy acknowledged, "the Queen of all Fairies told us that we must finish the lessons before your parents——"

"And aunt," interrupted Crow Shay.

"Yes," laughed Fairly Flew, "and aunt, come home."

"Oh, dear," cried Mary Frances, "I love my lessons so much, and yet I do want my father and mother home."

"Never mind," said the fairy, "never mind; let us finish the lessons as soon as we can; and afterward if you need me very much, and call me with the magic rhyme when no real people can overhear us, I will come sometimes to help you."

"Lovely letter!"



"Never mind."

"Oh, will you?" exclaimed Mary Frances, drying her tears. "That is a real comfort to think of."

"Now, go take a walk," continued Fairly Flew; "you have been indoors long enough for to-day."

"Take me walk, Mamma?" asked Mary Marie.

Mary Frances looked at the fairy.

"Shall I take her?" she asked; "and may I leave her sweater on?"

"Take her, by all means" answered the fairy; "and, if you wish, you may leave her sweater on."

"But suppose someone asks me who made it?" Mary Frances said.

"Just say that some dear friends of yours helped make it," the fairy told her.

"Will Mary Marie stay alive?" Mary Frances asked.

"The Queen of Fairies told me that she would be real while you are learning to crochet and knit, except when any other person than yourself looked at her. Then she will turn into a doll again."

"Oh, isn't this wonderful!" exclaimed the little girl, putting on Mary Marie's cap. "I'll try to take a walk where no one will notice us—and I'll come early



"She will turn into a doll."



"Take me walk, Mamma?"

for a lesson to-morrow. I love my lessons so much that I never want to stop learning."



"All work, and no play
Will make you dumb as me, Crow Shay,"

sang Crow Shay as Mary Frances went out.

"All work
and no play."



Mary Frances went out.



HE next morning when Mary Frances went into the sewing room, Fairly Flew was sitting in the rocker waiting for her.

"Is there anything which you particularly would like to learn to make?" she asked.

"Yes," replied Mary Frances. "I would love to learn how to make an outfit for the aviator doll in Billy's airship."

"Hurrah!" cried Crow Shay.

"Hurrah!" cried Knit.

"Hurrah!" cried Knack.

"Why are they so pleased?" asked Mary Frances.

"Because that is just what we had planned," said Fairly Flew. "So listen while I tell you how to make—



Waiting for her.

[195]

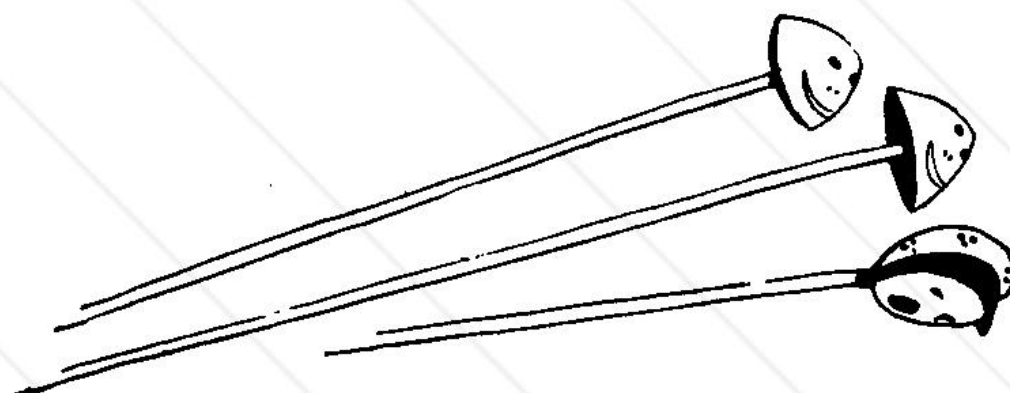

"Hurrah!"

AVIATOR DOLL'S KNITTED HELMET

(See picture opposite page 168—color plate)

One pair knitting bone needles No. 3.

Material: Olive drab or khaki color knitting worsted.

Directions:

1. Cast on 22 stitches.
2. Knit plain 76 ribs (a rib is a row across and back).
3. Bind off.

To Make the Helmet

Fold it across the middle and sew (overhand) 2 edges together the length of the doll's head in back with the yarn. Then sew front edges together for a short space under the chin.



"Ready for war."

AVIATOR DOLL'S KNITTED WRISTLETS

Material: Olive drab wool.

One pair No. 12 steel knitting needles.

Directions:

1. Cast on 18 stitches.

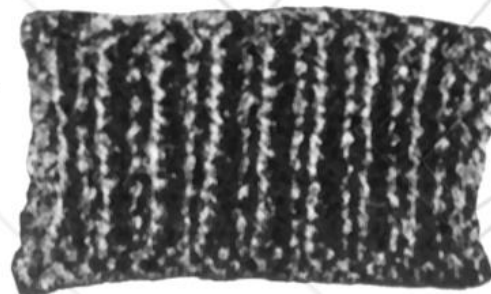

"Or cold."

2. Knit 1 stitch; purl 1 stitch.

3. Continue knitting 1 stitch and purling 1 stitch until wristlets are $1\frac{3}{4}$ inches long.

4. Fold edges together and sew up sides, leaving small opening close to one end for the thumb.

AVIATOR DOLL'S KNITTED SLEEVELESS SWEATER

Material: Olive drab or khaki color knitting worsted.

Knitting needles: One pair No. 3 bone, and one pair No. 12 steel. One crochethook No. 3.

Directions:

1. With the steel needles cast on 36 stitches.

2. Knit 2 and purl 2 for 12 rows.

3. Next take one of the bone needles in your right hand and knit plain—all the

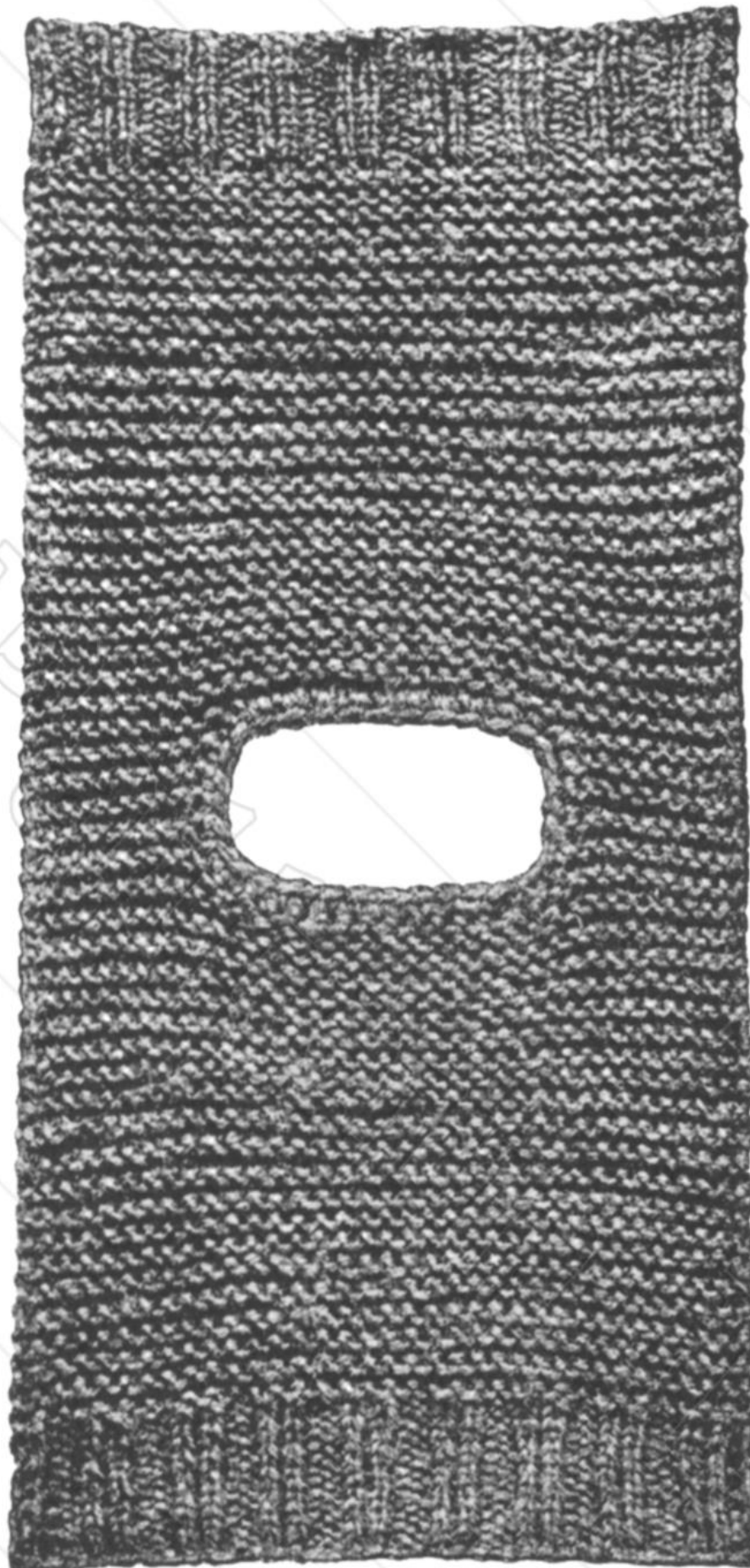

"See me knit."

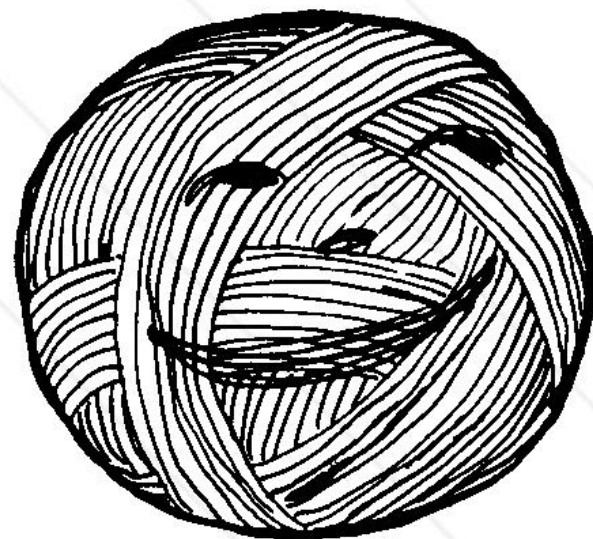

"Look who'se here!"

198 KNITTING AND CROCHETING BOOK

stitches off the steel needle. Then knit 22 ribs with the bone needles.

4. Knit 11 stitches and slip on to safety pin, in order to begin to form the neck.

5. Bind off 14 stitches for neck.

6. On the remaining 11 stitches knit 4 ribs for the shoulder.

7. On this same needle cast on 14 stitches to form opposite side of neck. (See method of Casting On, pages 260 and 261.)

8. Slip the 11 stitches (see No. 6) and the 14 new stitches on another safety pin.

9. Take up the 11 stitches from the first safety pin (see No. 4) with a bone needle. Fasten wool at neck end; knit 4 ribs.



Slip on
safety pin.

10. Knit back to outer edge of sweater. Then slip the stitches off the other safety pin on to the same bone needle with the stitches made in direction No. 9.

11. Make 22 ribs plain knit.

12. Now take a steel needle in your right hand, and plain knit the stitches on the bone needle off on to the steel needle.

13. Knit 2 and purl 2 for 12 rows and bind off the work.

14. Sew sweater up under the arms, leaving about a 3-inch opening for each arm.

Sew the sweater together in same way as in making the Doll's Knitted Sleeveless Sweater.

15. Put 1 row of single crochet stitches around the neck and armholes for a finish. Do not make the stitches too tight.

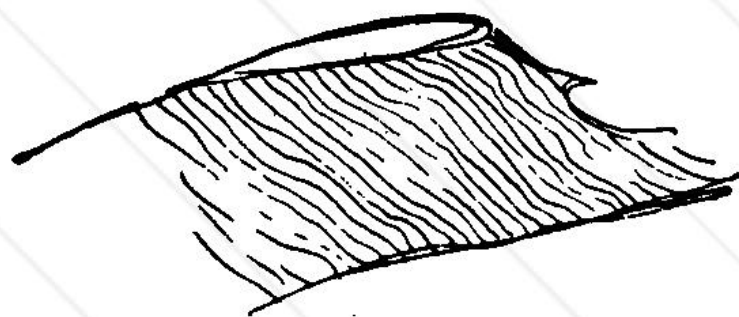

Sew together.

The fairy let Mary Frances use her magic needles, and the little outfit was finished before three o'clock in the afternoon.

Mary Frances put the sweater and wristlets and helmet on the doll and hid it away.

"I do not believe that Billy will miss it," she told the Knitting and Crocheting People; "and I do want to surprise him some day. He will be so pleased."

"That chap won't take cold on any of his air trips, no matter how high he goes," remarked Crow Shay,

"In coldest weather,
Without a feather,
He'll feel like a bird
Upon my word."

"Oh, you're a little parrot-bird yourself. Keep still, will you?" whispered Wooley Ball, laughing.

"Perhaps Crow Shay is as pleased with this outfit as I am!" exclaimed Mary Frances.

"We all are, I think," said Fairly Flew. "It was a good idea to ask you about what you wanted to

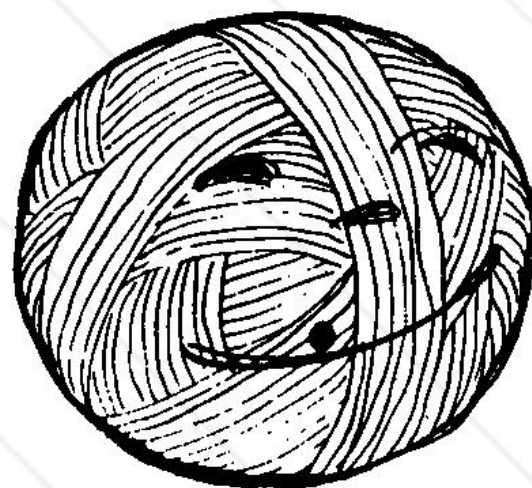

"Keep still, will you?"

learn to make. Think up something for our next lesson."

"Mamma," whispered Mary Marie, "Mary M'rie wants a boo'ful steater wif a wooly tollar."

"A sports sweater!" cried Mary Frances, softly. "The very thing!"

"A sports sweater! The sweet little thing doesn't want much, does she?" said Crow Shay, who overheard. "I could write all she doesn't want on a butterfly's wing." But no one paid any attention to him.

Mary Frances began to thank Fairly Flew for asking her about what she wanted to make, but before she could do so the fairy was gone.



"Sports
sweater."



"Steater wif wooly tollar."



READY FOR CHURCH

FOR DIRECTIONS FOR MAKING KNITTED ARTICLES SHOWN IN THIS ILLUSTRATION SEE
BEDROOM SLIPPERS—108 CROCHETED MITTENS—211 CROCHETED SOCKS—228
KNITTED MUFF—257 KNITTED BOA—257 CROCHETED NECKLACE—253

Antique Pattern Library



O the next day Mary Frances told Fairly Flew about what Mary Marie had asked, and the fairy gave her directions for making—

DOLL'S KNITTED SPORTS SWEATER

(See picture opposite page 72—color plate)

Material: Rose pink or turquoise blue wool floss, with gray Angora or teazle yarn for trimming.

Two bone knitting needles No. 3. Two steel knitting needles No. 10. Bone crochet hook No. 2. Two small button molds.

Directions:

This work is begun at the back of the sweater.

1. With pink or blue yarn cast on 40 stitches.
2. Knit plain for 15 ribs (a rib is a row across and back).

[201]



Mary Marie.

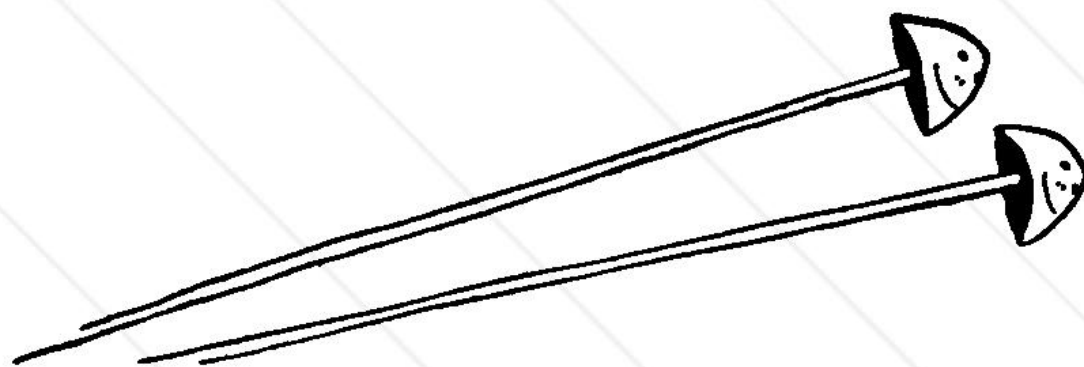

Bone knitting needles.

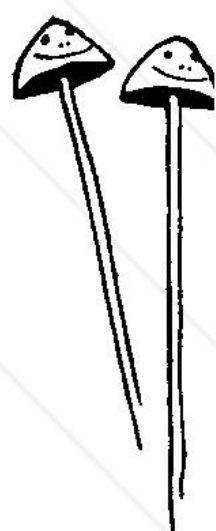
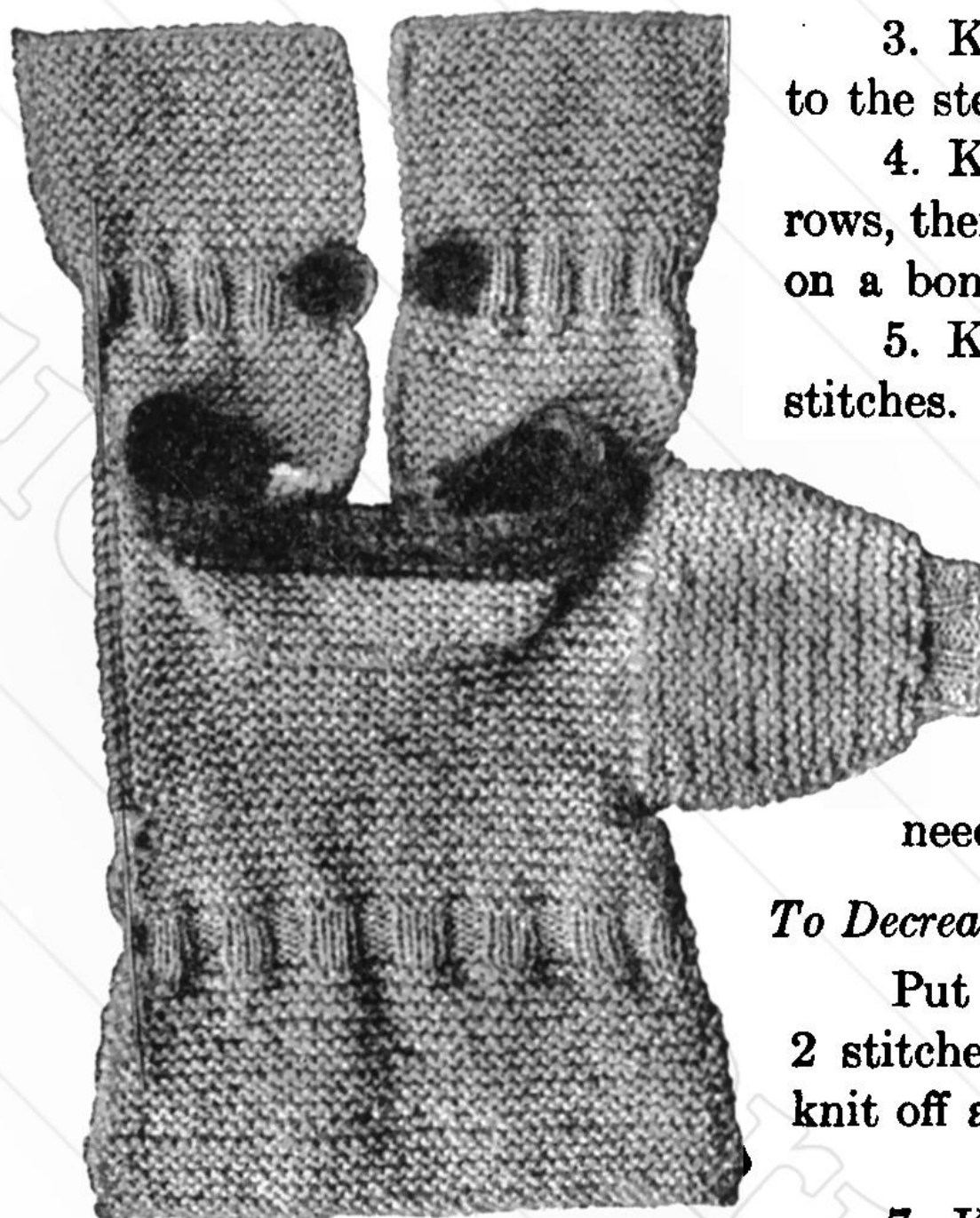

"We made that!"

3. Knit the stitches off on to the steel needle.
4. Knit 2, purl 2 for 8 rows, then knit off the stitches on a bone needle.
5. Knit 5 ribs of 40 stitches.
6. Then decrease 1 stitch on each end on every rib (every other row) until there are only 32 stitches on the needle.
7. Knit ribs of 32 stitches until there are 16 ribs from the waist line.
8. Knit 10 stitches on the next row, and slip them off on a safety pin.
9. Bind off 12 stitches for back of neck. There will now be 10 stitches on the needle.
10. Knit 4 ribs on these 10 stitches for shoulder.

To Decrease Stitches in Knitting

Put right needle through 2 stitches on left needle and knit off as 1 stitch.



"Aren't we proud!"

To Make One Front

11. Cast on 8 stitches* on neck end for front—to form revers.
12. Knit 6 ribs plain on the 18 stitches now on the needle.
13. At under-arm edge increase by casting on 1 stitch on each rib until there are 24 stitches.
14. Knit plain until there are 17 ribs from the front of the neck down.
15. Take the stitches off on the steel needle and knit 2, purl 2, for 8 rows.
16. Knit the stitches off on to the bone needle and knit 15 ribs, and bind off.

To Make Other Front

17. Slip the stitches from the safety pin on to a bone needle. Fasten wool at neck end, and make other front like the one just finished.

To Make Sleeve

1. With bone needle, holding right side of sweater toward you, pick up 1 stitch on each rib around the armhole. (See page 202.)

There should be 22 stitches on the needle, 11 on each side of center of shoulder. If you prefer, pick these stitches up with a crochet hook, and slip them on a knitting needle.

2. On these 22 stitches, knit 10 ribs.
3. On each end of the eleventh rib from the shoulder, narrow by taking off 2 stitches as 1.
4. Knit twelfth rib plain.

*See How to Cast On Stitches with Knitting Needle, pages 260 and 261.



On safety
pin.

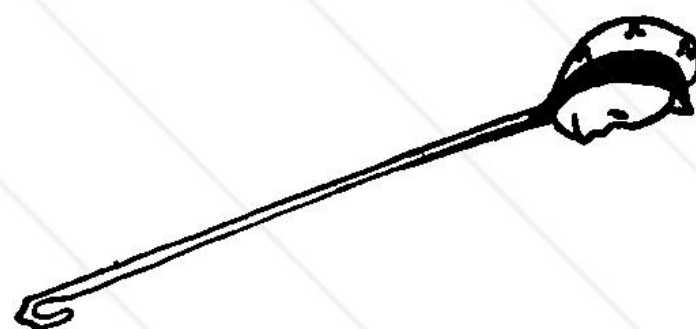

"Ten ribs!"

204 KNITTING AND CROCHETING BOOK

5. Narrow on each end of the thirteenth row by taking off 2 stitches as 1.

6. Continue to knit plain ribs until there are 19 ribs from the shoulder. Take off on to steel needle.

7. Make 6 rows of knit 2, purl 2.

8. Knit 1 rib plain.

9. With wrong side of work toward you, fasten on the trimming wool. Knit 2 ribs, and bind off. (See cuffs, opposite page 72, color plate.)

10. Make another sleeve like the one just finished.

To Make the Collar

1. With steel needles cast on 38 stitches of wool like body of sweater.

2. Knit 6 ribs plain.

3. Attach trimming yarn. Knit 4 rows, increasing 1 stitch at each end of needle every other row.

4. Bind off.

5. Hold right side of collar toward you. Pick up 1 stitch on each rib on one front end of collar, and knit 4 rows, increasing 1 stitch toward the corner on every other row. See picture below.

6. Bind off.

7. Do the same to the other end. Be sure to keep neck end even.

8. Sew up mitered corners.

9. Sew collar to neck of sweater.

10. Sew sweater up under arms.

11. Sew sleeves down to hand.



Knit 6
ribs.

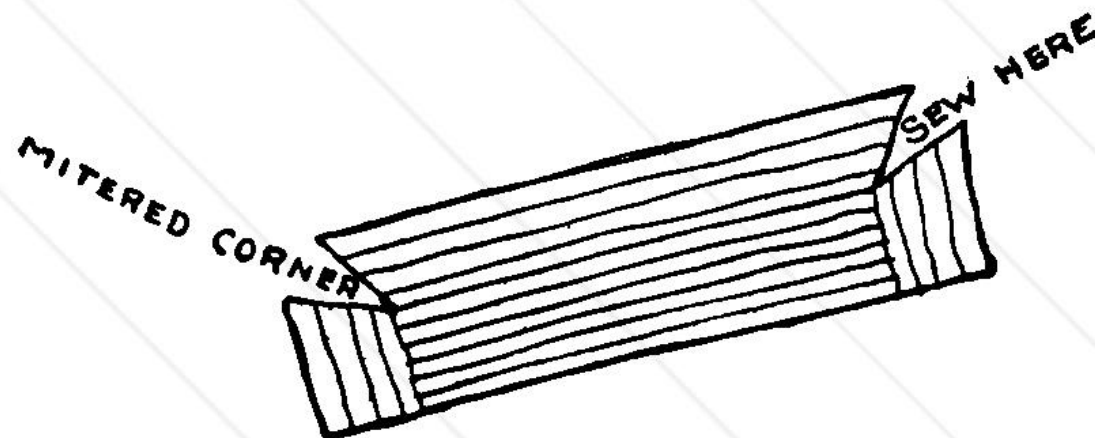

To make collar.

To Make the Cover of the Buttons

1. With the trimming yarn, make 3 chain stitches.
2. Put 8 single crochets in second chain stitch.
3. Second row. Put 1 single crochet in first single crochet stitch (through both loops), 2 single crochets in second stitch, and so on to end of the row.
4. Make 1 row without increasing and break off yarn.
5. Thread a long-eyed needle with the yarn and sew cover over a button mold. Sew mold into place at waist of sweater.
6. Make another button in the same way and sew it in place.

To Make Loops for Buttons

7. Fasten floss to one edge of ribbed waist line of sweater, and crochet a chain of 7 stitches. Fasten last stitch at other edge of waist line with a slip stitch. Break off floss and fasten. Make another loop on other side at waist line to fasten the other button.

Even with the magic needles it took Mary Frances the whole morning to make the little sweater; but it was beautiful when finished, and Mary Marie surprised everybody by turning a somersault when Mary Frances had put it on her.



What she does need."

"Now, I p'ay tennis and doff!" she exclaimed.

"Wish I had hat to doe wif it!"

"Just what she does need!" said Crow Shay, who



Turning a somersault

greatly admired the sweater. "Why not make her one?" and started to give the directions for making a—

LITTLE CROCHETED HAT

(See frontispiece and picture opposite page 230—color plate)

Material: To match any sweater.

Bone crochet hook No. 3.

Directions:

1. Make 3 chain stitches and join into a ring with slip stitch. Make 3 chains.

2. Put 16 double crochets in the ring (counting the 3 chains as if they were one double crochet) and join last double crochet stitch with the top of the 3 chain stitches.

3. Second row: Make 3 chains. Throw yarn over hook. Put hook under first 3 chains, in row below. Draw

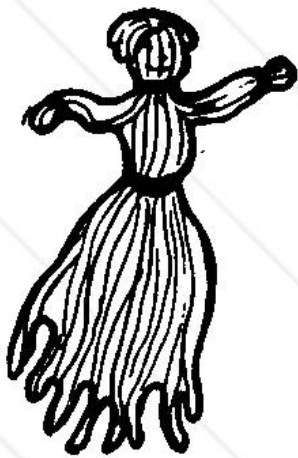

"A
beauty!"

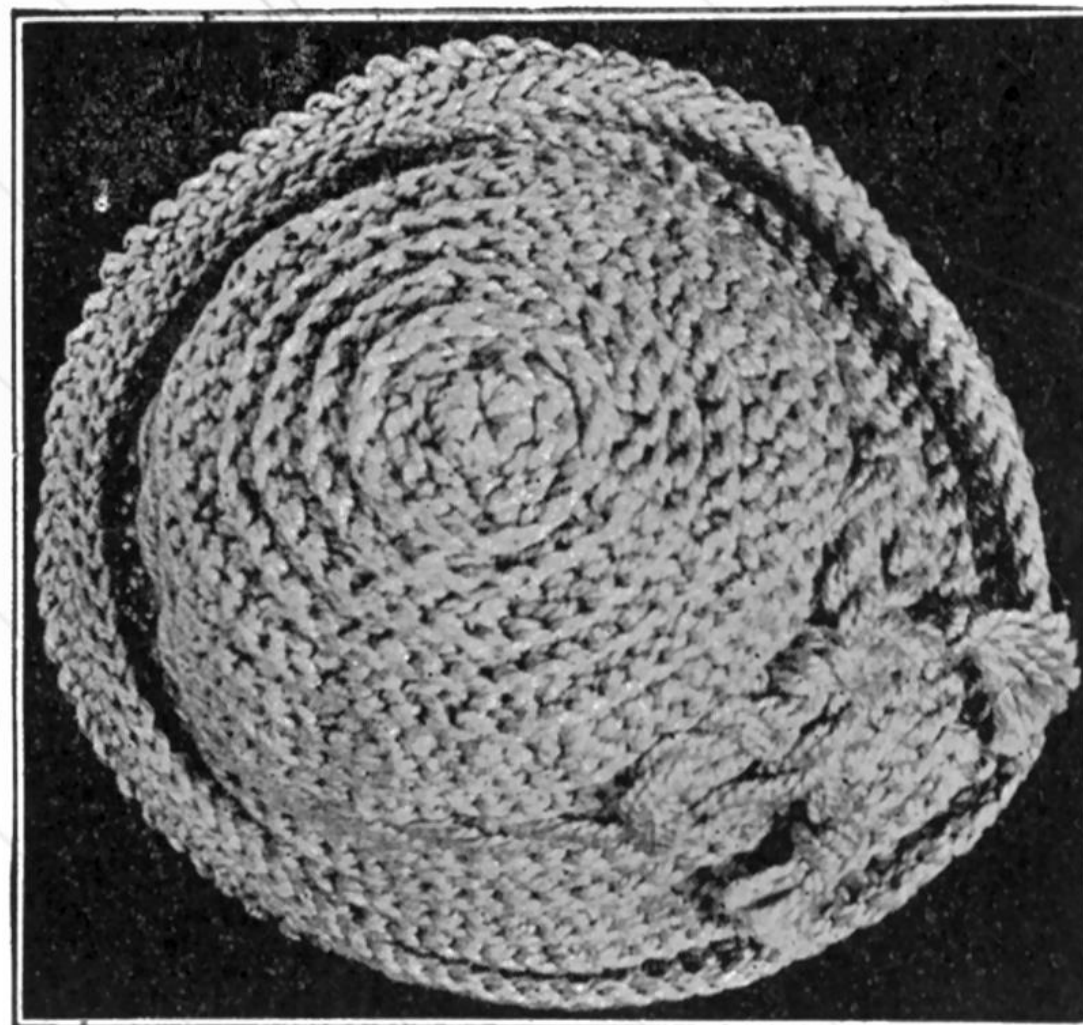

Sport hat.

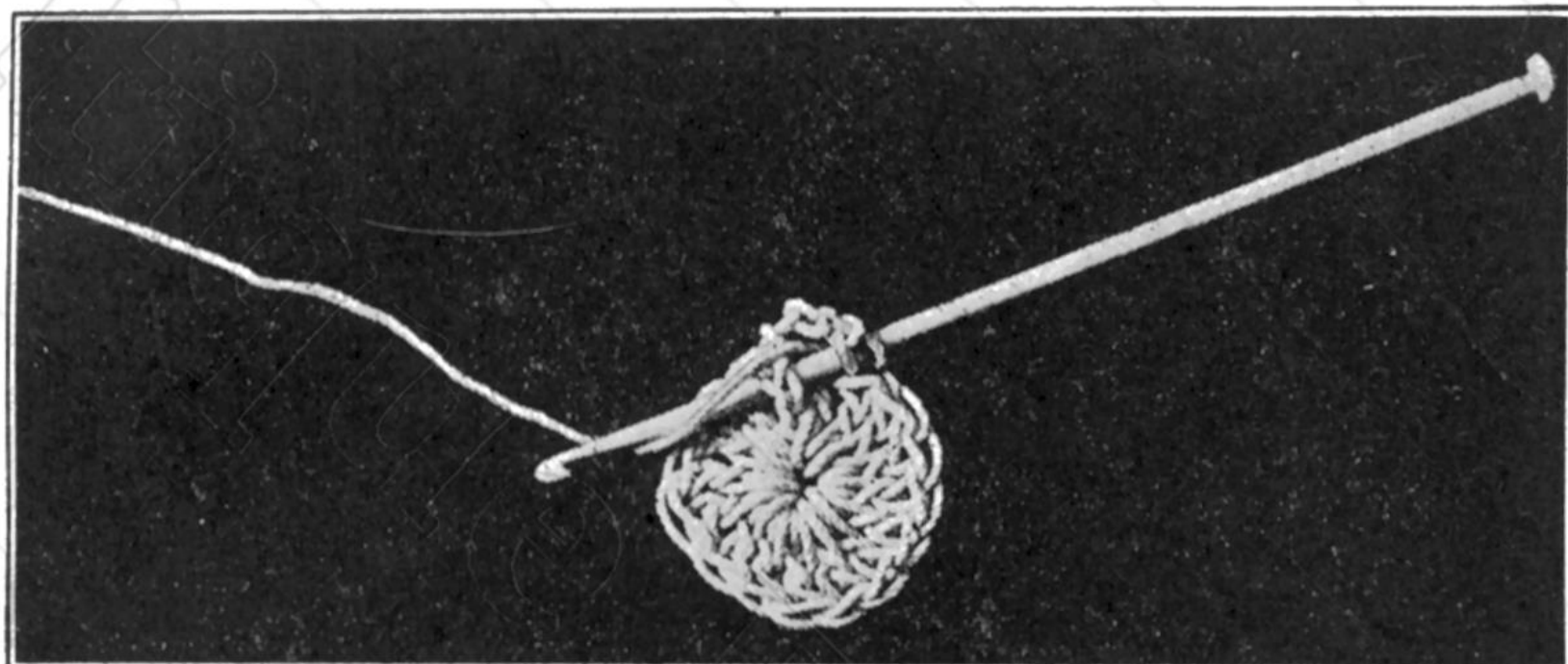

yarn through, and work off as a double crochet stitch. The next stitch is made in the same way: throw yarn over hook; put hook through under the whole double crochet stitch below and work off as a double crochet. (See picture above.)

The work will look like the picture A, on the side toward you; and like the picture B on the other side. (See page 208.)

The ridged side is the outside of the hat.

4. Put 2 double crochets around the next double crochet in the row below. Put 1 double crochet around the next stitch; 2 around the next—and continue in this way around the whole row. You should have 8 sections of 2 double crochets together with 1 double crochet between them when row is finished. Join last double crochet with top of the 3 chains.

5. Third row: Make 3 chains. Make 1 double crochet around the 3 chains of the row below. Put 1 double crochet around the first double crochet in row below. Put 1 double

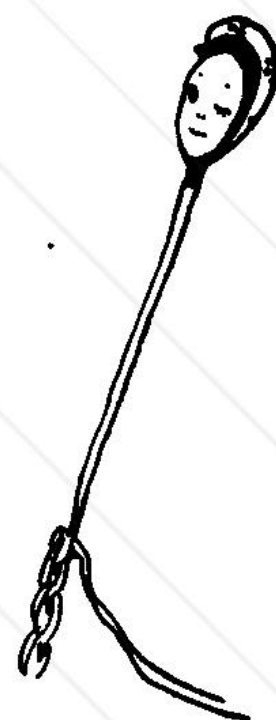

Make 3
chains.

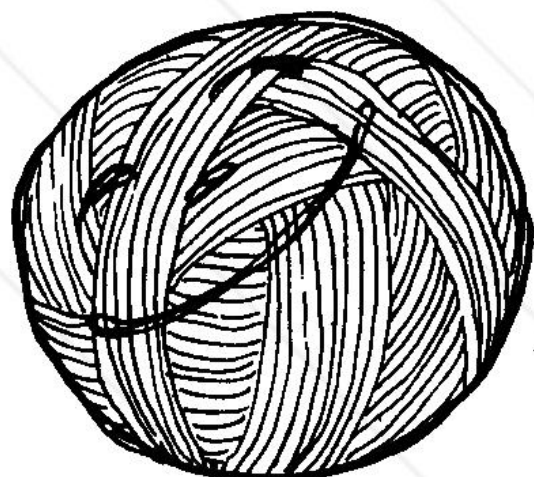

"Aren't we smart?"

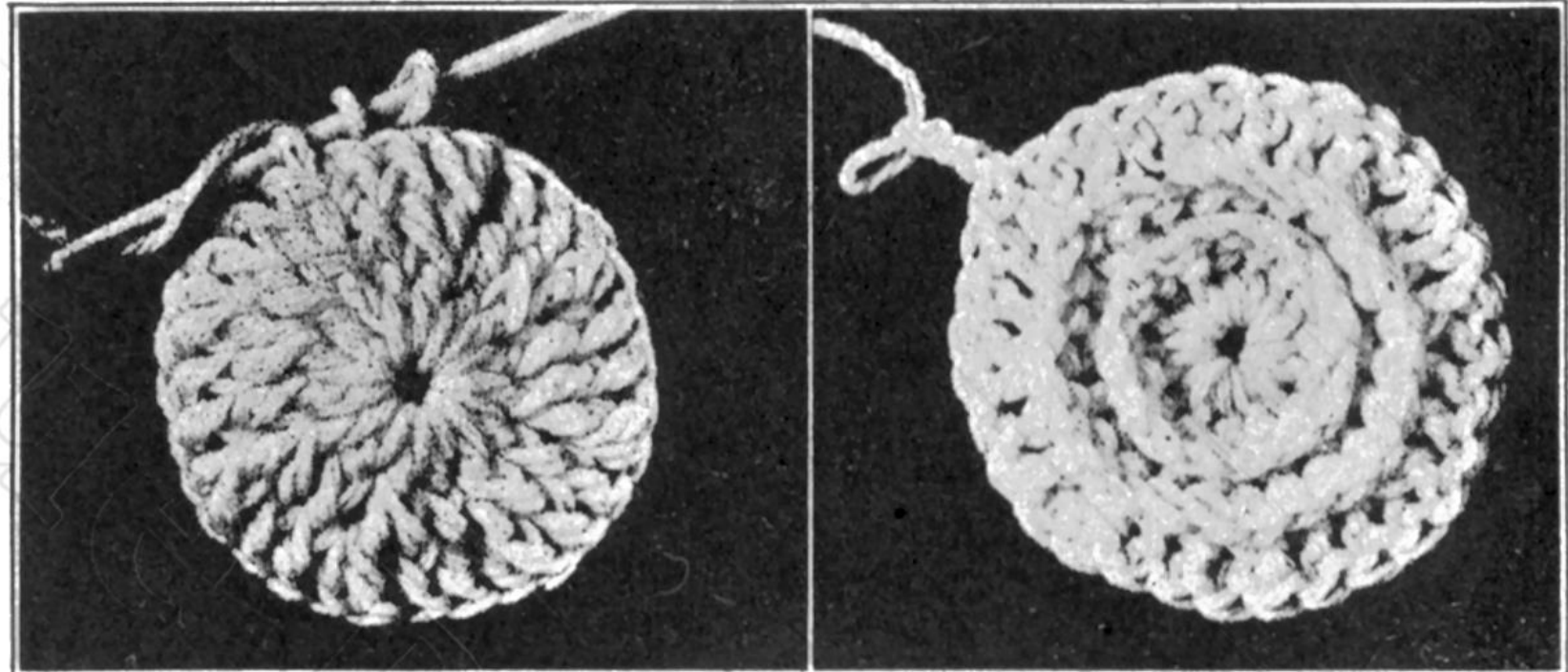

A

B



"Row! Row!
Row!"

crochet around the second double crochet. Put 2 double crochets around the third double crochet. Repeat this direction around the entire row, and join.

6. Continue making rows in this way, increasing as shown in the diagram below:

- 1st row—16 double crochet (dc stands for double crochet).
- 2d row—2 dc 1 dc
- 3d row—2 dc 1 dc 1 dc
- 4th row—2 dc 1 dc 1 dc 1 dc
- 5th row—2 dc 1 dc 1 dc 1 dc 1 dc
- 6th row—2 dc 1 dc 1 dc 1 dc 1 dc 1 dc
- 7th row—2 dc 1 dc 1 dc 1 dc 1 dc 1 dc 1 dc
- 8th row—2 dc 1 dc 1 dc 1 dc 1 dc 1 dc 1 dc 1 dc
- 9th row—2 dc 1 dc 1 dc 1 dc 1 dc 1 dc 1 dc 1 dc 1 dc
- 10th row—2 dc 1 dc 1 dc 1 dc 1 dc 1 dc 1 dc 1 dc 1 dc 1 dc



"Don't be saucy!"

In the tenth row you will have 9 double crochets between 2 double crochets. Take care to have all the increases in a row from center out.

7. Work the next 4 rows without increasing.

8. On the next row, make 1 double crochet around the first stitch of the row below;

1 double crochet around the next stitch;

2 double crochets around the next stitch;

and continue in this way to end of row. Join.

9. Make 2 rows without increasing. Break off yarn and tie on the trimming yarn.

10. Work 1 row of double crochet all around without increasing.

11. Make 1 row of slip stitches around the edge of hat.

To Make the Trimming

1. Cut 2 strands of trimming yarn and 2 strands of yarn the color of the hat, each 2 yards long.

2. Lay them together, side by side. Take hold of one end of them with the right hand, and the other end with the left hand, and twist them in opposite directions. Or get some one else to twist one end while you twist the other in the opposite direction.

3. Pull the twisted yarn "taut" or straight. Catch hold of twisted yarn in the middle and fold together taking all the ends firmly in one hand. Let go with the other hand. It will twist itself into a pretty cord.



Slip a
stitch.

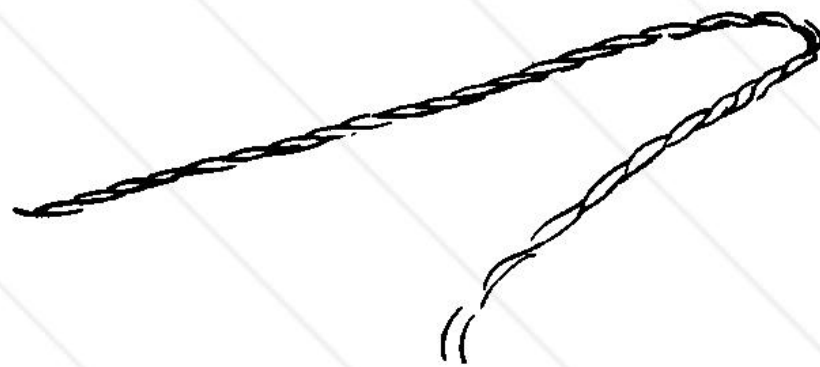

Twist a pretty cord.

4. Fasten balls made of the two colors of yarn on the ends of the twisted yarn. Make them as you made the pom-poms on doll's toque (page 95).

5. Tie twisted cord around hat in a bow knot and sew in place on the right side. Turn up the left side of hat in a soft roll.

Crow Shay was wild with excitement when Mary Frances finished the little hat and put it on Mary Marie's head.

"Look at yourself in the glass now, Mary Marie," he exclaimed. "You're the most beautiful——"

"Oh, don't make her too vain!" said Mary Frances. "She has had so much given to her that I'm afraid she will be spoiled as it is."

"She needs one thing more, though," said Crow Shay.

"What is that?" asked Mary Frances.

"Why, don't you see how cold her hands look?" asked Crow Shay.

"Hands told!" said Mary Marie. "Hands told!"

"Oh, you little mischief!" laughed Mary Frances. "You little scamp! I don't think your hands are cold."

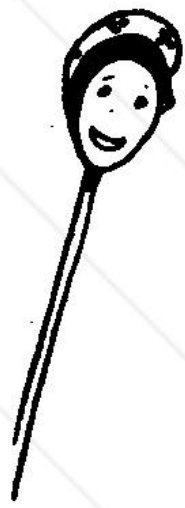

Crow Shay
was wild.



"Hands told!"

She felt of them. "They do not seem a bit cold," she said.

"All the same," said the Yarn Baby, "you would like to know how to make her a pair of—

DOLL'S CROCHETED MITTENS*

(See pictures opposite pages 136 and 200—color plates)

Material: Two-fold Saxony wool. Mercerized knitting cotton for trimming.

Bone crochet needle No. 1.

Directions:

This work is begun at the top of the fingers.

1. Make 3 chain stitches, and join in a ring with a slip stitch.

2. Put 8 single crochets in the ring.

3. Put hook through both loops at top of stitches in row below, and work on around and around, adding an extra stitch in about every fifth stitch, until there are 18 stitches in the row.

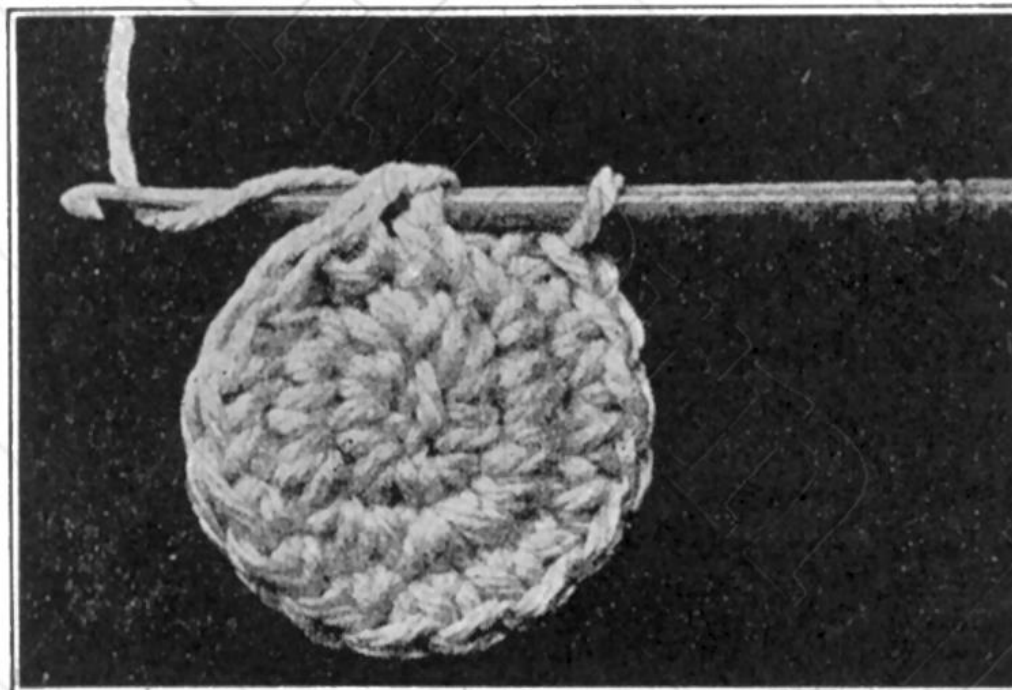

"All the same."

*The doll's mittens are so small that they are difficult to make. It would be a good experiment to make one mitten with wrapping yarn before attempting to use the saxony wool—just for practice.



"See my mittens?"

This will bring the work to the joint or crotch of the thumb.

To Make Opening for the Thumb

4. Make 3 chain stitches, and continue to make single crochet stitches. Do not skip any stitches for the opening of the thumb,

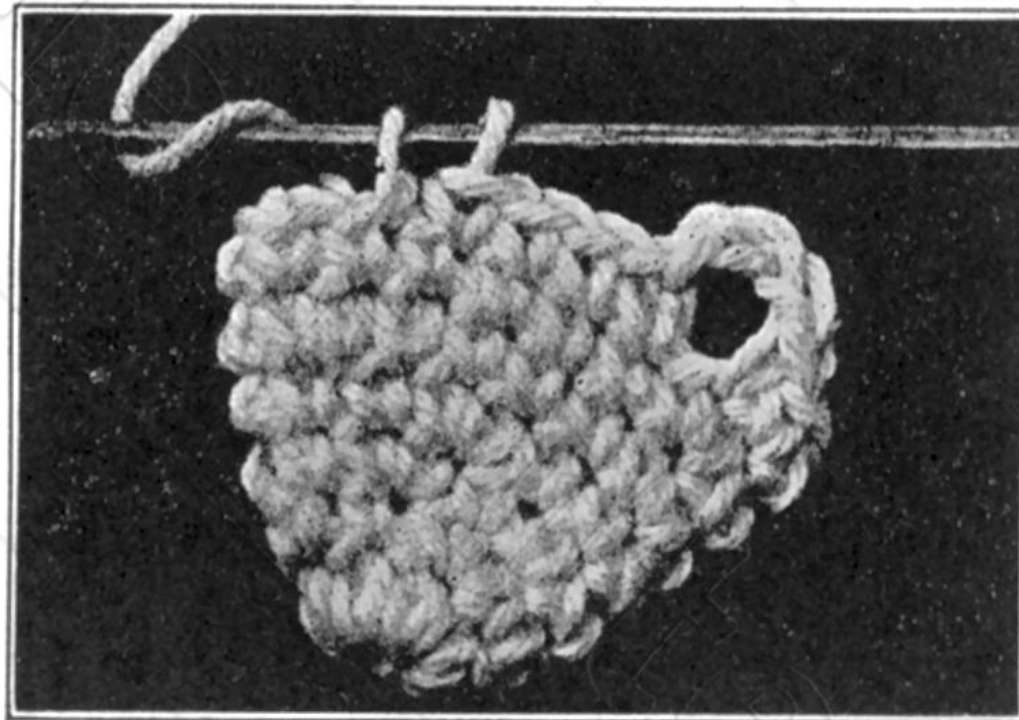

but make single crochet stitches all around on the 18 single crochet stitches, and in the 3 chain stitches—that will make 21 stitches.

5. Make another row of single crochet stitches on the 21 stitches.

6. Continue to work single crochet stitches, but on the next 2 rows, skip 1 stitch directly over the thumb opening.

This finishes the hand of the mitten. The thumb will be made later.

To Make Runner Spaces at Wrist

Make 3 chain stitches. Make a row of double crochet stitches.

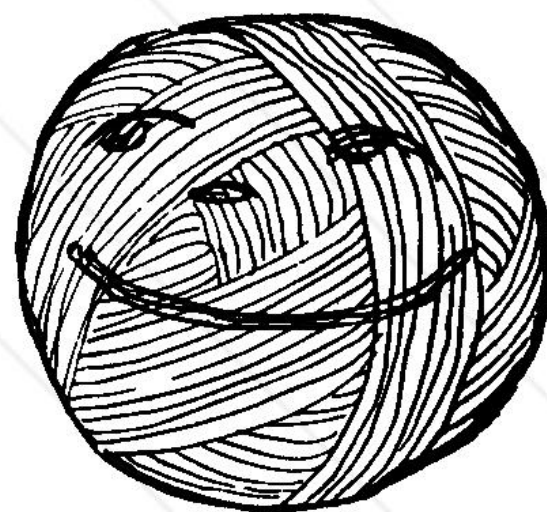

"Look at these mittens"

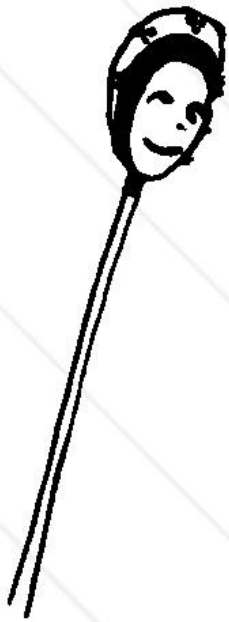

"Aren't they tiny?"

To Make Trimming Scallops

1. Put 1 single crochet stitch between the first and second double crochet stitches.
2. Put 3 double crochets between the next 2 double crochets.
3. Put 1 single crochet between next 2 double crochets, and 3 double crochets between the next 2. Continue to do this all around the top.
4. Tie on the trimming cotton, and make 1 slip stitch in each double crochet of the scallops, with 2 chain stitches between each slip stitch.

To Make the Thumb

1. Fasten yarn to the inner edge of the little opening. (See picture on page 212.)
2. Make single crochet stitches in the stitches around the opening, except on the top part of the thumb, where you should put 1 double crochet. (That is, in the middle chain stitch. See No. 4 on page 212.)
3. Continue with single crochets.
4. Second row: Same as the first.
5. Third row: Make single crochets in every other stitch, drawing the thumb down to a point. Break off the yarn and draw end with a zephyr needle into the inside of the thumb.

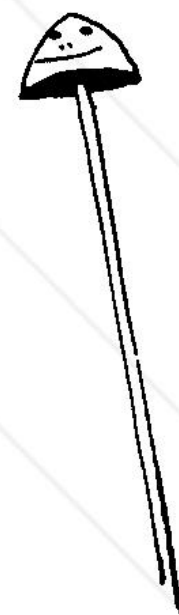

"So you
won't lose."

To Make the Runner

With the trimming cotton, make a chain of 50 chain stitches, and run through the runner spaces as in making doll's petticoat (page 90.)

NOTE.—To keep dolly from losing her mittens fasten them together

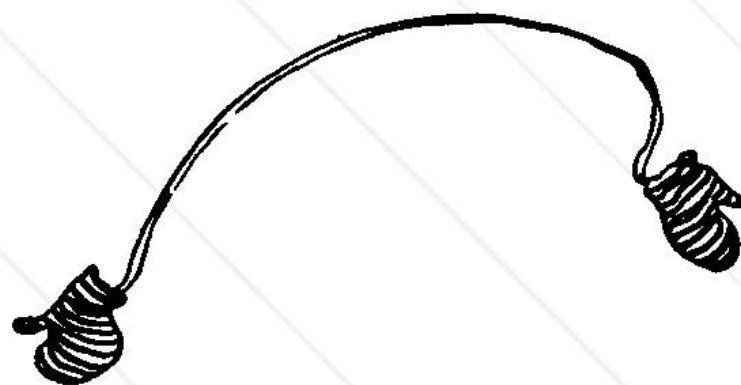

Fasten together.

Mary Marie no sooner had the mittens on than she ran to the door of the room.

"Tum on, Mamma," she said, "let's doe for a walk." Mary Frances caught her up in her arms, and after a hurried good-bye to the Knitting and Crocheting People, went out with her.



"Tum on,
Mamma."



"Good bye!"



HE next morning Mary Frances was awakened early by a ring of the door bell.

"I'll run down to the door," called Billy. "I am up and dressed. I wonder who it can be?"

"All right!" called Mary Frances, slipping into her kimono.

"It's a telegram from mother," said Billy, coming upstairs.

"Oh, good! Do read it!" Mary Frances could scarcely wait to have it opened.

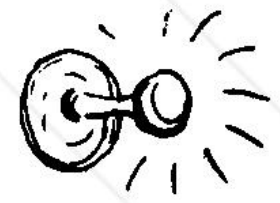

Ring of the door bell.

*Will be home Tuesday. Meet the 10 o'clock train.
All well.*

Mother.

[215]



A telegram from Mother.

read Billy. "Hurrah! That means that father is better than they even hoped and that they can all come sooner than they expected."

"Why!" he exclaimed suddenly, "to-day is Tuesday! Isn't it fine that the telegram came in good time!"

"Yes, indeed!" said Mary Frances. "And how happy I am."

They hurried with their breakfast, and then went out to gather some flowers to decorate the house.

They were at the station half an hour too early for the train, and when at length it did pull in, you can imagine what a delightful time everyone had.

"It seems a thousand years since I last saw you, Father dear," said Mary Frances, kissing him, "and a hundred since Mother and Aunt Maria left; doesn't it, Billy?"

"Well," laughed Billy, "it seems an awfully long time, if not a thousand years."

"Do not talk too much to your father, children; he cannot bear too much excitement," warned Aunt Maria, as Billy led the way to the taxicab which was to take them home.



"How happy I am."



Father dear.

"You can tell the driver to stop at my house, Billy," said the old lady, who was quite nervous when riding in an automobile.

"Horseless carriages are so unnatural. It always seems to me like riding behind a headless horse to ride in an automobile," she added.

Of course the children had hard work to keep from laughing.

When they came to her house, Billy carried her bags to the door and rang the bell for her.

"Tell your father to remember not to sit in a draft," she called to Billy as he ran down the path, "and tell Mary Frances to be ready for a lesson in knitting next Thursday evening."

"We heard, Billy," said his father, as Billy jumped into the taxicab, "didn't we, daughter?"

"What have you done all the time, dear?" asked her mother.

"I'll tell you some time, Mother," said Mary Frances.

"Another secret?" asked her mother.

"I guess it is," remarked Billy. "She has been as good and quiet as a mouse most of the time up in the



Billy carried
her bags.



"Don't sit in a draft."

sewing room. She says she has been practicing knitting. If she has been practicing all this while, she must know a lot by now."

Her mother smiled and patted her hand, and by that time they were at their own home.

Katie was at the door and was almost as glad as the children to see their father and mother.

"It seems so good to have you all home," she said, "that now life will be worth the living of it."

All tried to help make the invalid comfortable, and the children left him to take a little nap before lunch.



Mother
smiled.



Katie was at the door.



MARY FRANCES went to the sewing room.

"My dear friends," she whispered.
"My father and mother have come home,
and I'm so glad! But I shall be very sad if I am not to
have any more lessons with you."

"You have learned enough already," said the
Yarn Baby, "to make almost anything if you have the
directions."

"Do you really think that?" asked Mary Frances
in surprise.

"It is most certainly quite true
That you know more
Than you think you do,"

[219]



"My dear
friends."



"You have learned enough."

said Crow Shay solemnly. "That's more than can be said of most people," he added, after a pause.

"But I haven't any directions," sighed Mary Frances

"If I were you,
If I were you,
I'd call the fairy,
Fairly Flew."

sang Crow Shay, and Mary Frances took the hint.

When the fairy Fairly Flew came at the call of the rhyme, she brought a little satchel in her hands. It was not much larger than Mary Frances' thimble.

"How do you do this morning, little Miss Mary Frances?" she asked. "I've been waiting to be called, for I have a present for you from the Queen of All Fairies."

"Oh!" gasped Mary Frances, "for me?"

"Yes, in my satchel," said the fairy.

"It cannot be anything for my dolls," thought Mary Frances, "because the satchel is too little to hold them."

Then the fairy took a tiny key from her pocket



Sang
Crow Shay.



Fairly Flew came.

A GIFT FROM THE QUEEN OF FAIRIES 221

and unlocked the satchel. She opened it and began to pull a paper out. It was such a thin strong paper that before long the fairy had unrolled yards of it out of the little satchel into a pile on the table.

“Read it,” she said; and when Mary Frances lifted the end, she saw that on it were written directions for making all kinds of things for dolls, and for people, too.

“Oh,” she cried, “the Queen of Fairies couldn’t have pleased me better! What a lot of wonderful things I can make now. Please thank her for me, Fairly Flew.”

“That I shall,” said the fairy. “But wait—I have not yet given you all that is in the bag. Here are some magic needles just like mine—for a little girl who tried and tried again, and kept on trying.”

“Oh, like the Needle-of-Don’t-Have-to-Try!” exclaimed Mary Frances. “How wonderful! Please, please, tell the Queen of All Fairies that I thank her more than I can tell her.”

“Do you know what would please her more than anything else?” asked Fairly Flew.

“No,” Mary Frances said. “Will you please tell me what it is?”



Needle-of-
Don't-have
to-Try.

“How-wonderful!”

"To tell other little girls how to do the things you have just learned to do," said the fairy.

"How perfectly delightful!" exclaimed Mary Frances. "I can get the girls to form a knitting club, can't I?"

"Yes," said the fairy, "get all your little friends to join, and make many of the pretty things that this paper explains about."

"How I wish I could tell my mother about our lessons," said Mary Frances.

"You may tell her. The Queen of Fairies sent word that you might do so if you asked when the paper was——"

Suddenly the fairy disappeared. The Knitting Twins fell down. Wooley Ball and the Yarn Baby fell over on their sides.

"Oh!" cried Mary Frances; then she looked around and saw her mother standing in the door.

"Oh, Mother dear, come in," she cried. "The most wonderful thing has happened since you've been away!" And she told about the crocheting and knitting lessons, and the gifts from the Queen of All Fairies.

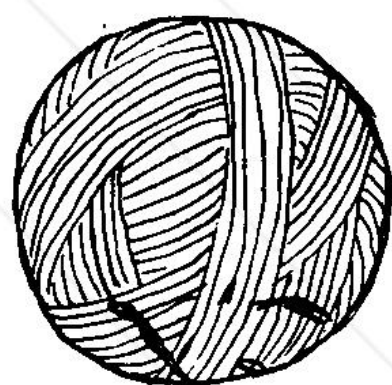

Wooley Ball
fell over.

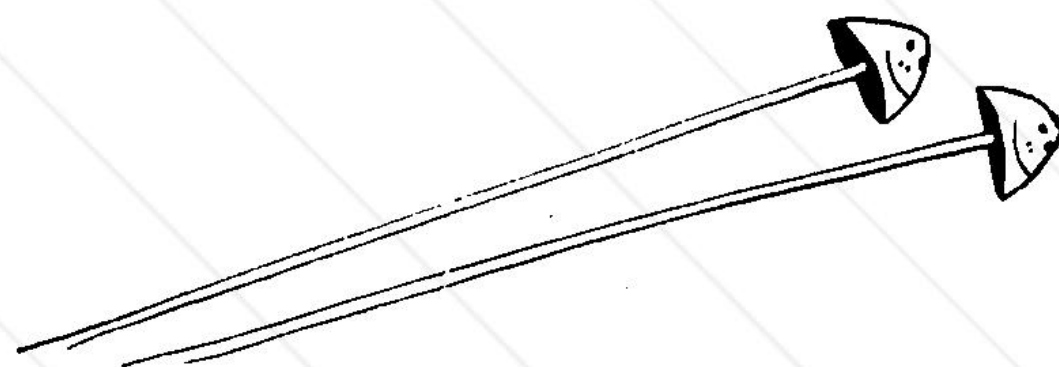

Knitting Twins fell down.

A GIFT FROM THE QUEEN OF FAIRIES 223

“Wasn’t it lovely!” exclaimed her mother. “I am so glad! Just wait a minute,” and she went out of the sewing room.

Very soon she was back, carrying a long package which she handed to the little girl.

“A present from father and me,” she said.

Mary Frances opened the package and lifted out a wonderful infant doll which could open and shut its eyes and could cry when lifted on its side.

“Oh, how dear!” cried Mary Frances. “Nothing could please me so much. I wonder if the Queen of All Fairies knew you were bringing it? There are directions on this paper for making an infant’s outfit.”

“Perhaps she did,” said her mother. “Perhaps she planned the directions with this in mind.”

“Aren’t fairies and mothers wonderful people?” laughed Mary Frances, hugging her mother and the new doll at once.

“Not any more so than good little daughters,” said her mother, kissing her.

“Now, I must go to father,” she added. “Lunch will be ready in a short time.”



“A present from us.”

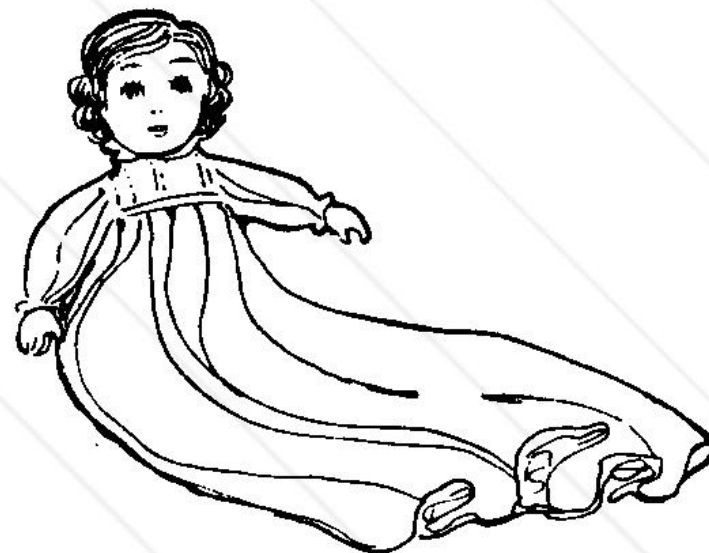

A wonderful infant.



Mary
Frances



ARY FRANCES carried her new dolly over into the playroom and laid her down on the little bed by Mary Marie. Then she returned to the sewing room.

"It seems lonesome without my dear friends," she thought, "but I believe they will all come to life again if I really need them. I couldn't expect to keep Fairly Flew all the time, for many other little girls will need her."



I wish I could tell you about the good times she had making the garments and gifts which were told about on the fairy's paper; how Mary Marie and the new baby came to life when Mary Frances was follow-

The new dolly.

[225]

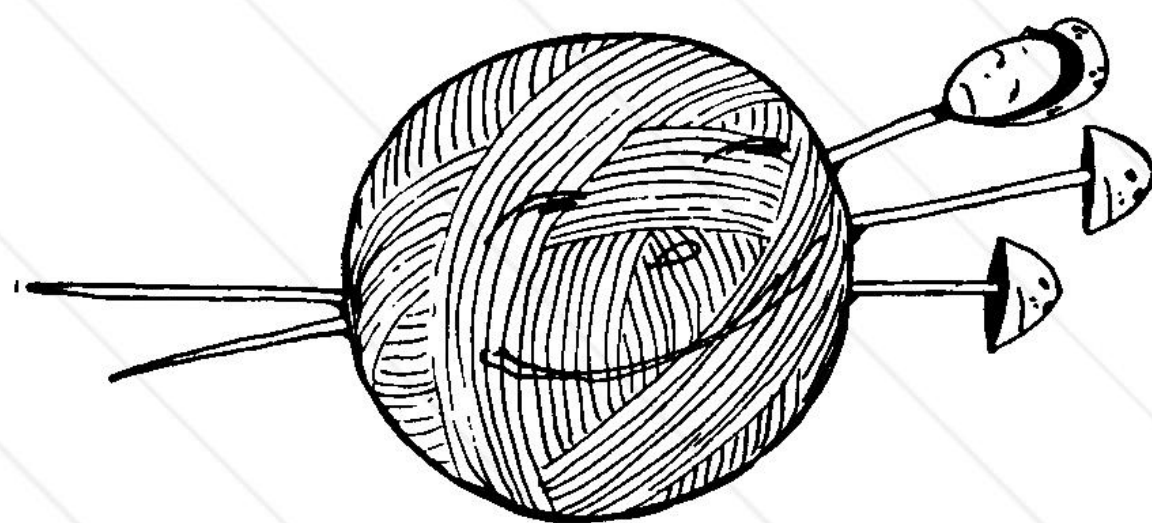

"Without my dear friends."

ing the directions; how Mary Marie loved the new baby, and petted it, and held it in her lap even though it was nearly as big as herself; how pleased Billy was with his airship doll; how surprised and delighted and proud Aunt Maria was when she found out how much Mary Frances knew; how Mary Frances did form a Knitting Club and how the girls and a few boys made many, many useful garments for people who needed them—but that would take another book as long as this one.



Proud
Aunt Maria

But I can give you the directions which were on the paper that the Queen of All Fairies sent her by Fairly Flew, and you will find them in the next chapter.

Mary Frances told me this whole story herself, and asked me to write this book so that you who read it may have some such pleasure as she had in learning how to crochet and knit.



Mary Frances told me.



THESE are the instructions which were found on the paper which the Queen of All Fairies sent to Mary Frances by the fairy, Fairly Flew.

INSTRUCTIONS

NOTE TO BEGINNERS: Before attempting to make any of the following articles, make those given in the story part of this book.

The articles that follow need not be made in the order given.

ABBREVIATIONS USED IN CROCHETING AND KNITTING

When you look at the directions usually given for making crocheted and knitted articles you will find the names of the stitches abbreviated. Although *abbreviations are not used in this book*, it is well to know those in the following list:

sc.	- - - - -	single crochet
dc.	- - - - -	double crochet
tr.c.	- - - - -	treble crochet
sl.st.	- - - - -	slip stitch
ch.st.	- - - - -	chain stitch
st.	- - - - -	stitch
k-	- - - - -	knit
*- - - - *	- - - - -	repeat directions between stars.

NOTE.—In order to become familiar with these abbreviations—think of single crochet as “sc.”, and of double crochet as “dc.” Instead of using the words, use the letters when you read the directions. Say “2 s-c’s” or “3 d-c’s”; not 2 single crochets, or 3 double crochets.

TREBLE CROCHET

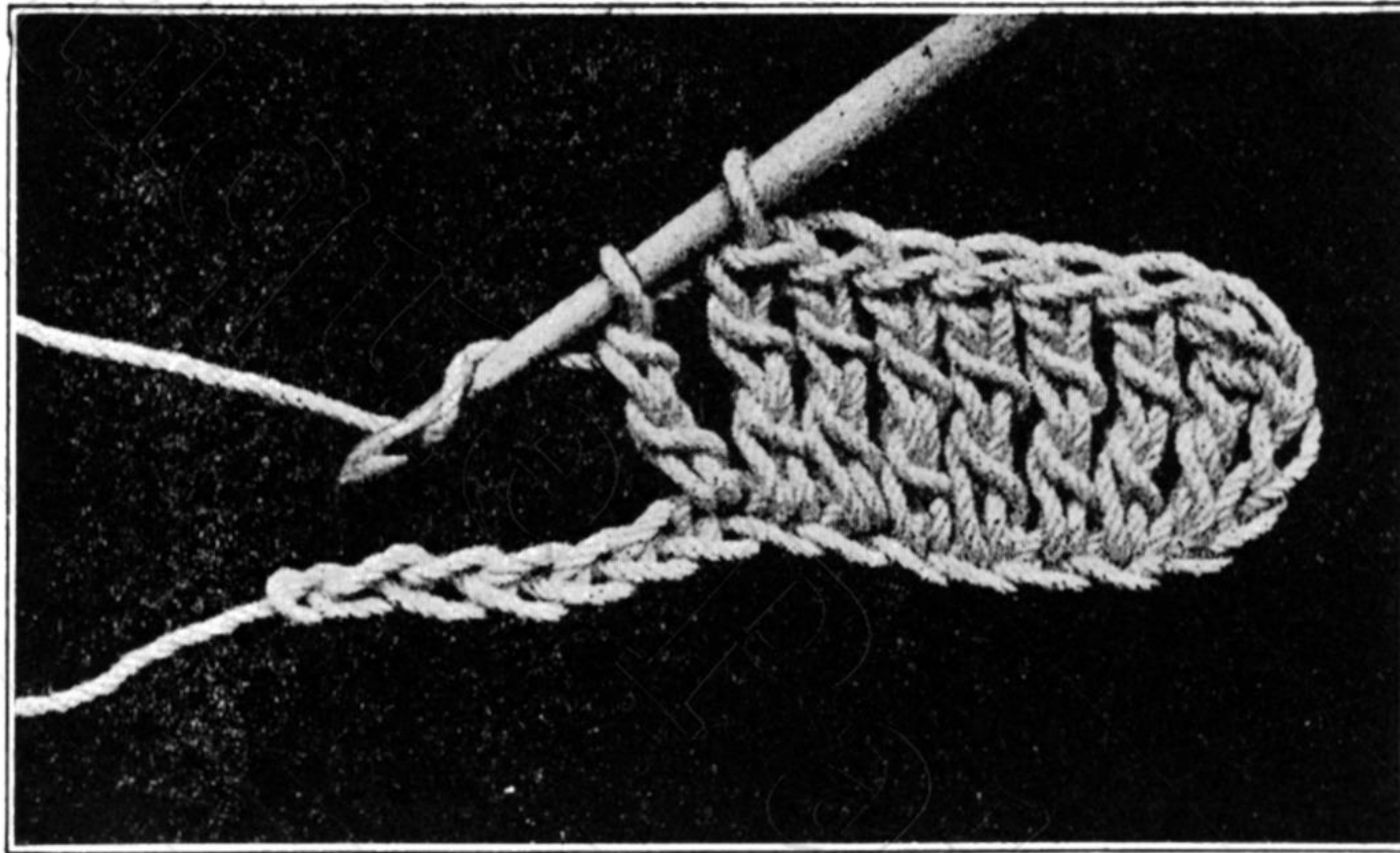

In making Treble Crochet make about 15 chain stitches. Skip 3 chains. Wrap the yarn around the needle *twice*, before putting hook through the chain stitch. Wrap, and draw yarn through chain stitch. Wrap, and draw yarn through 2 loops. Wrap, and draw yarn through 2 loops. Wrap, and draw through 2 loops.

INFANT DOLL'S CROCHETED SOCKS

(See pictures opposite pages 136 and 200—color plates)

Material: Three-fold Saxony wool. Pink or blue (mercerized) silk for trimming. Bone crochet hook No. 2.

Directions:

The work is begun with the ankle part.

1. Chain 15; that is, make 15 chain stitches.
2. Skip 1 chain and put 1 single crochet in each of the 14 stitches. Chain 1 to use in turning.
3. Taking the back thread only, make 1 single crochet in each of the 14 single crochets. The two rows just made will form a rib. This kind of rib is called "slipper stitch." Make 1 chain in turning.
4. Make 2 more ribs like the one just made. Make 1 chain in turning.
5. Make 8 single crochet and 1 chain stitch. Make 8 single crochet. These two rows of single crochet will form a shorter rib. Make 1 chain stitch.
6. Make 8 more ribs on the 8 stitches.
7. Join the last row of stitches with 8 of the first chain stitches made, using slip stitch.

To Form the Foot:

8. Put 1 single crochet in each stitch around the bottom of the part just made, taking up both threads.
9. Make 4 more rows.
10. Fold sock together from toe to back, and crochet together with slip stitch.

To Make the Scallops:

1. Fasten the wool into the top of the sock at the back, and make 1 single crochet.
2. Put 4 double crochets in the top of the next rib.
3. Put 1 single crochet in the top of the next rib.
4. Repeat No. 2 and 3 around the top of the sock. Break wool and fasten.
5. Fasten the trimming silk into the top of the scallop at the back of the sock.

Make 1 single crochet.

6. Make 5 double crochets in the single crochet stitch between the scallops of wool.

7. Repeat No. 5 and 6 around top of sock. Fasten the silk.

To Make the Runner.—With the silk make about 35 chain stitches. Run these through the top of the sock at the bottom of the white scallops and fasten a small tassel on each end of the runner.

For trimming, thread a sewing needle with the pink silk and make 4 cross stitches on the center rib. Make 1 cross stitch on each side of the second cross stitch from the top cross stitch.

INFANT DOLL'S CROCHETED CAP

(See picture opposite page 136)

Material: Three-fold pink or white Saxony, with three-fold deep pink Saxony for trimming. Bone crochet hook No. 2.

Directions:

1. Chain 3; that is, make 3 chain stitches. Join in a ring with slip stitch.
2. Chain 3, and make 16 double crochets in the ring. Join last double crochet with slip stitch to the top stitch of the 3 chain stitches. This makes the first row.
3. Second row: Chain 3. Make 2 double crochets in each stitch of first row, taking back thread (back loop of stitch) only. Join.
4. Third row: Chain 3, and make 1 double crochet in the first stitch of the row below. Make 2 double crochets in the second stitch. Continue to do this to end of row. Join.
5. Fourth row: Chain 3 and make 2 double in every third stitch. (Make 1 double crochet in the other stitches.) Join.
6. Fifth row: Make 2 double crochets in every fourth stitch.
7. Sixth row: Make 1 double crochet in each stitch of fifth row. Break off the yarn and fasten end.
8. Seventh row: In the ninth stitch from joining, fasten yarn and make 3 chain stitches.
9. Put 1 double crochet in each stitch of row below, leaving 16 stitches without any stitches taken in them. That is, leave 8



stitches on each side of the joining. This will be the back of the neck. Break off and fasten yarn.

10. Make 7 rows (in all) putting 1 double crochet in each stitch of row below. Break off wool and fasten at end of each row.

To Make Trimming Bands:

1. Hold the inside of the cap toward you, and fasten the trimming wool at the right-hand corner.

2. Make 3 chains. Put 1 double crochet in each stitch all around the cap. Join. Make 3 more rows like this.

Fold the band back against the face and up around the neck of the cap, folding the extra fulness at the corners into a mitered shape. Sew in place with a long-eyed needle threaded with pink wool, and fasten rosettes and tie-ribbons at the sides.

INFANT DOLL'S CROCHETED SACQUE NO. 1*

Material: Pink, or light blue, or white, four-fold Saxony wool. Bone crochet hook, No. 2.

Directions:

This work is commenced at the neck.

1. Chain 50; that is, make 50 chain stitches.

2. Make 11 double crochets.

3. Put 2 double crochets in the twelfth chain stitch.

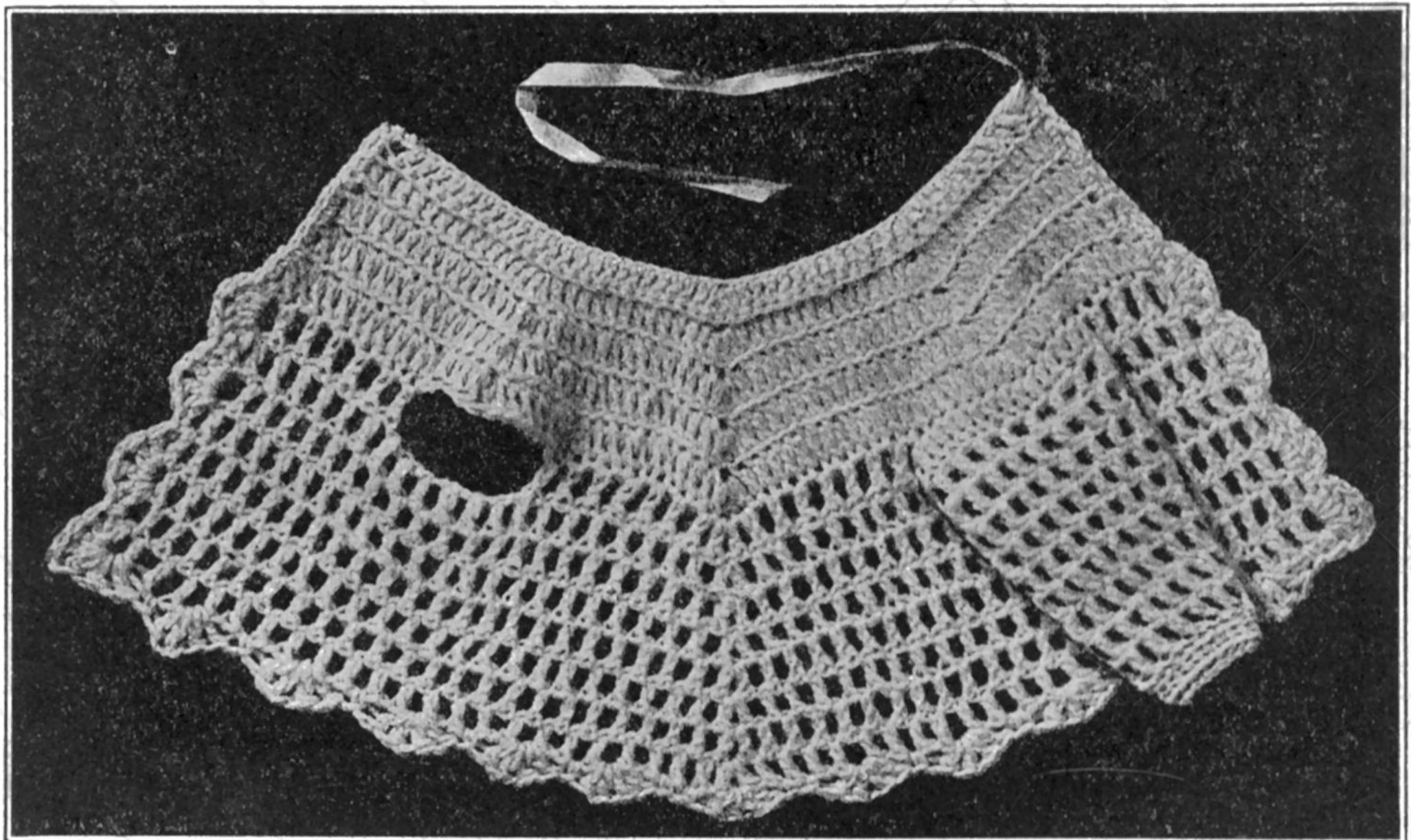

* This sacque is easy for children to make, and should be made before Sacque No. 2.



FLOWERS FOR MOTHER

FOR DIRECTIONS FOR MAKING KNITTED ARTICLES SHOWN IN THIS ILLUSTRATION SEE
LITTLE CROCHETED HAT—206 FLOWER BASKET—246 KNITTED HOOD—176
KNITTED SILK SWEATER—259 BABY'S CROCHETED BALL—252

Antique Pattern Library

THE MAGIC PAPER

231

4. Make 12 double crochets.
5. Put 3 double crochets in the thirteenth chain stitch.
6. Make 12 double crochets.
7. Put 2 double crochets in the next chain stitch.
8. Make 11 double crochets. Break off yarn and fasten end. Do not turn the work.
9. Second row: Attach yarn at right-hand end.

TO ATTACH NEW YARN

Put the needle through the stitch and put a slip knot on the hook. Draw the slip knot through the stitch; or, thread a zephyr needle with the new yarn and run it into the loose end on the work; or, twist the two ends of yarn together.

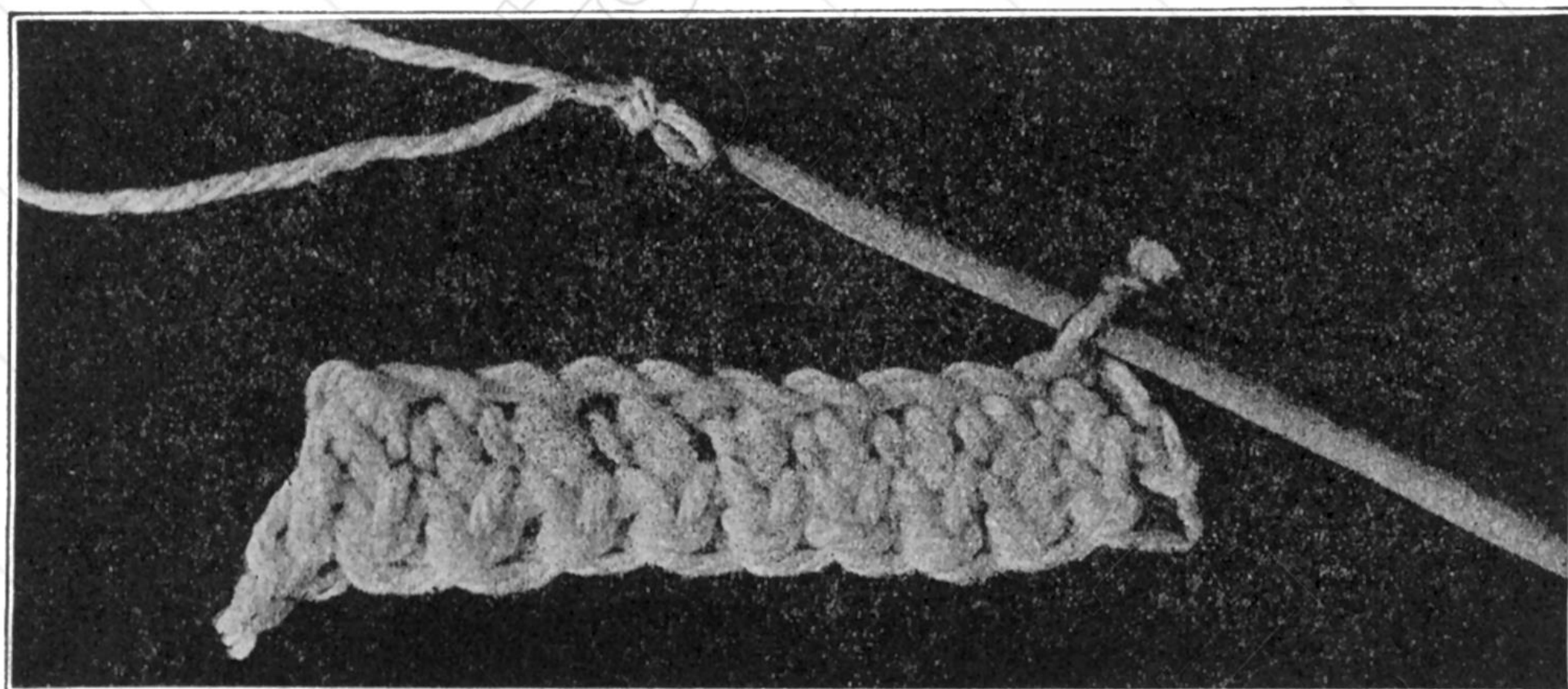

10. Chain 2. Taking the back loop only, make 12 double crochets. Put 3 double crochets in the next stitch.
11. Make 1 double crochet in each stitch until you reach the cluster of 3 double crochets. Put three double crochets in the middle double crochet of the cluster.
12. Make 1 double crochet in each stitch until the cluster of 2 double crochets is reached. Put 3 double crochets in the first of the 2 double crochets. Put 1 double crochet in each stitch to end of row. Break off yarn, and fasten end.
13. Third row: Attach yarn. Chain 2. Make 1 double crochet in each stitch except in middle stitch of clusters. Put 3 double crochets in the middle stitch of each cluster. Break off yarn and fasten.
14. Fourth and fifth rows: follow direction No. 13.
15. Sixth row: Same as fifth row, except that in starting, 2 double crochets are put into the first stitch; 2 double crochets are also put into the last stitch.
16. Seventh row: Chain 2. Turn the work.
17. Putting hook under both threads, make 1 double crochet in the next stitch. Chain 1. Skip 1 stitch. Put 1 double crochet in the next stitch.

To Form the Armhole:

18. Keep on in this way (see No. 17) until there are 7 double crochets. Make 12 chain stitches, Count 7 stitches from the middle stitch (counting the middle stitch) in the first cluster of double crochets in the sixth row. Put 1 double crochet in the eighth stitch beyond the middle stitch of the cluster.

19. Continue according to direction No. 17.

20. Put 2 double crochets, with 1 chain stitch between, in the middle stitch of the cluster of double crochet in the middle of the back of sacque.

Continue according to direction No. 17, until within 7 stitches from middle stitch of last cluster of double crochet in sixth row. Make 12 chain stitches and form other armhole. Continue by direction No. 17 to end of row.

21. Eighth row: Follow direction Nos. 16 and 17, putting 2 double crochets in the first and the last stitches of the row in order to widen the front. The double crochets are put under *two* threads in the chain stitches of the row just made.

22. Ninth, tenth, eleventh, twelfth, thirteenth and fourteenth rows: Like eighth row. Break off yarn and fasten end.

To Make the Sleeve:

1. Attach yarn to middle chain stitch underarm. Chain 2. Put double crochets all round the armhole. Join last stitch to chain with a slip stitch.

2. Next row. Chain 2. Put 1 double crochet in the next stitch. Chain 1. Put 1 double crochet in next stitch. Continue around row and join first and last stitches.

3. Continue direction No. 2 for 3 more rows. Narrow in the next 4 rows by omitting the chain between the double crochet every other stitch.

4. Chain 1. Put a row of single crochet around end of sleeve. Join.

5. Putting hook under back thread, make another row of single crochet. Break off yarn and fasten end.

To Make the Trimming:

The sacque in the picture is trimmed with a wool and silk Saxony yarn. It may be trimmed with the yarn used for the sacque.

1. At the left corner of the neck attach the yarn. Make slip stitches down left front to the first open space.

2. In the space, put 2 double crochets, and 1 chain, and 2 double crochets.

3. Make 1 single crochet in the next space.

4. Continue direction No. 2 to corner of sacque.

5. In the corner, put 3 double crochets, and 1 chain, and 3 double crochets.

6. Continue to make scallops in this way all around sacque, finishing edge of yoke part with single crochets as in direction No. 1 above.

Finish sacque at neck by drawing a ribbon runner under every other stitch.

INFANT DOLL'S CROCHETED SACQUE NO. 2.*

(See picture opposite page 136)

Material: Three-fold pink Saxony wool. Bone crochet needle No. 3. This needle should be a long even one, because the yoke of the sacque is made with

*This piece is difficult for children to make.



INFANT DOLL'S CROCHETED SACQUE NO. 2

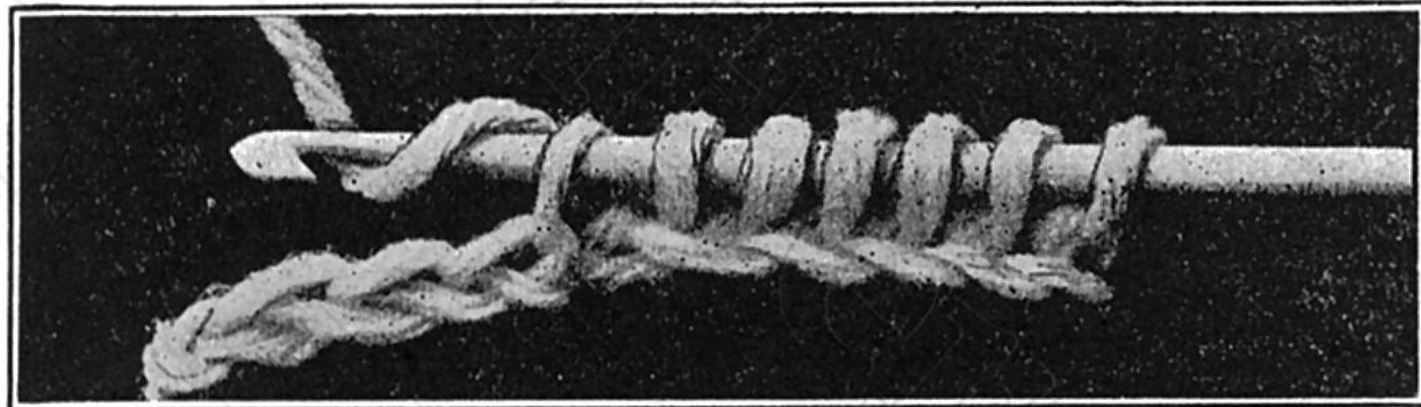

CUT
1

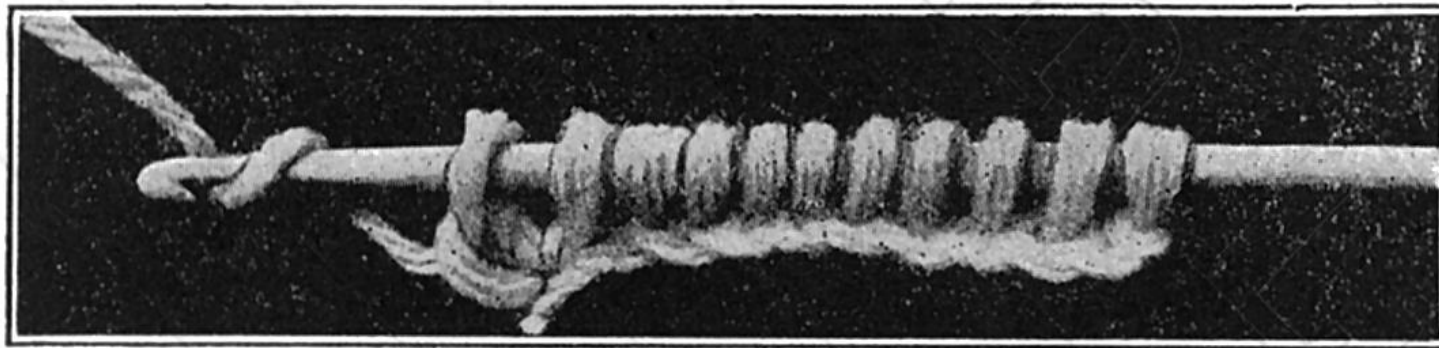

CUT
2



CUT
3

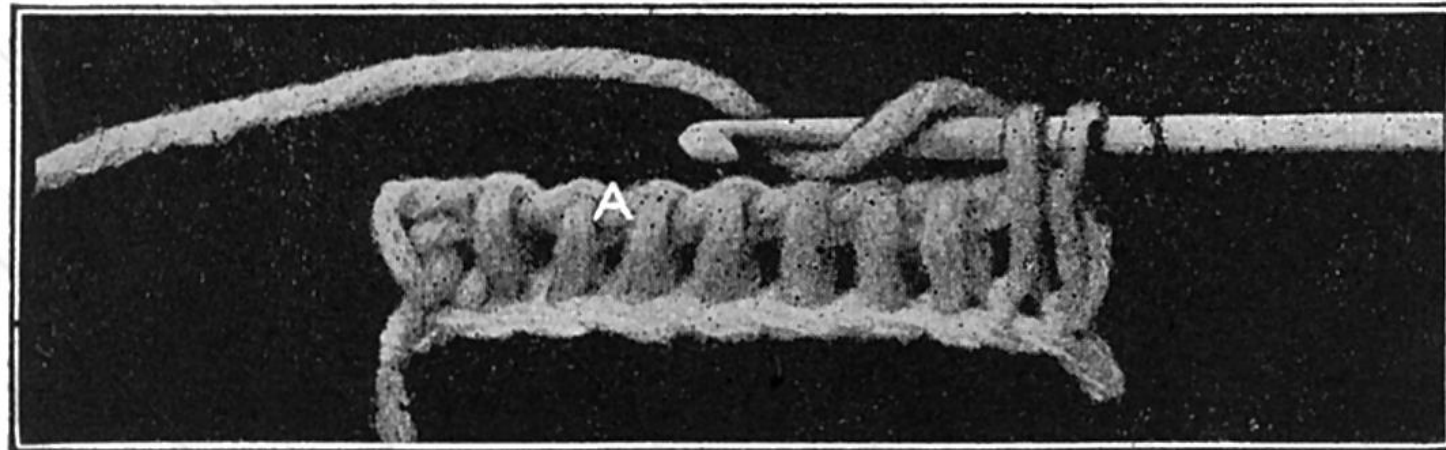

CUT
4

DETAILS OF AFGHAN STITCH

AFGHAN STITCH

Before beginning the sacque, practice making afghan stitch with four-fold Germantown wool.

Make 9 chain stitches. Pull a loop through *each* stitch of the chain except the one next the needle. That is, skip one chain. See Cut 1, page 233.

Pull a loop through the loop nearest the hook. Cut 2.

Pull a loop through the next two loops nearest the hook. Continue to pull a loop through two loops in this way (Cut 3) until only one loop remains on the needle.

You will now notice the long straight upright loops on the front, or the right side, of your work. Cut 4.

Put the hook under the nearest long loop on the *front* of the row of stitches just made, and pull a loop through. Cut 4. Continue to pull loops through the entire row in this way, and take the loops off the needle in the same way as they were pulled through the stitches in Cuts 2 and 3.

Directions for Making the Sacque:

Begin the work at back of yoke which is made with afghan stitch.

1. Chain 30; that is, make 30 chain stitches.
2. Keeping the last chain stitch on the hook, pull a loop through each stitch of the chain (except the one next to the needle) making 30 loops on the needle.
3. To take the stitches off, throw the yarn over the hook, pull hook through first loop. Throw yarn over the hook. Pull hook through 2 loops.
4. Continue to pull hook through 2 loops until but one loop remains on needle.
5. Pull a loop through each long loop (do not count the chain stitches on the edge as a long loop), leaving each on the needle. Do not turn the work, always work on the right side.
6. Repeat direction No. 3 and No. 4.
7. Make 10 rows of afghan stitch.
8. On the next row make loops in 10 stitches only—to form shoulder.
9. Make 6 rows of 10 stitches.
10. Now add 1 stitch, at the neck end only, on each row until there are 15 stitches.
To add a stitch.—Draw up a loop through the top thread between the loops of the row below. See “A” in Cut 4, page 233.
11. Continue to work on these 15 stitches until there are 10 rows, or 26 rows from the starting of the yoke.
12. To make strip down the front.—Make slip stitch in 9 loops. Then work 13 rows of afghan stitches on the remaining 6 stitches. Finish end of strip with 1 row of slip stitches.
13. To make other side.—Fasten yarn at right corner of back of neck. Make slip stitches in 10 stitches, and make 6 rows of afghan stitches on the other 10 stitches.
14. Increase on this side by making the extra loop between the first and second stitches until there are 15 stitches.
15. Work on the 15 stitches until there are 26 rows from the starting of the back yoke.

16. Then make front strip of 13 rows on the first 6 stitches, and finish strip like on other side.

17. Make slip stitches all around yoke.

18. Fasten yarn at one lower corner of yoke, back. Chain 8 and fasten end stitch to one lower corner of yoke, front, for armhole.

19. Do the same for other armhole.

To Make Body of Sacque:

Fasten yarn at left side corner of yoke leaving about a 3-inch end hanging and work across bottom of yoke and across the under arm chain stitch in this way:

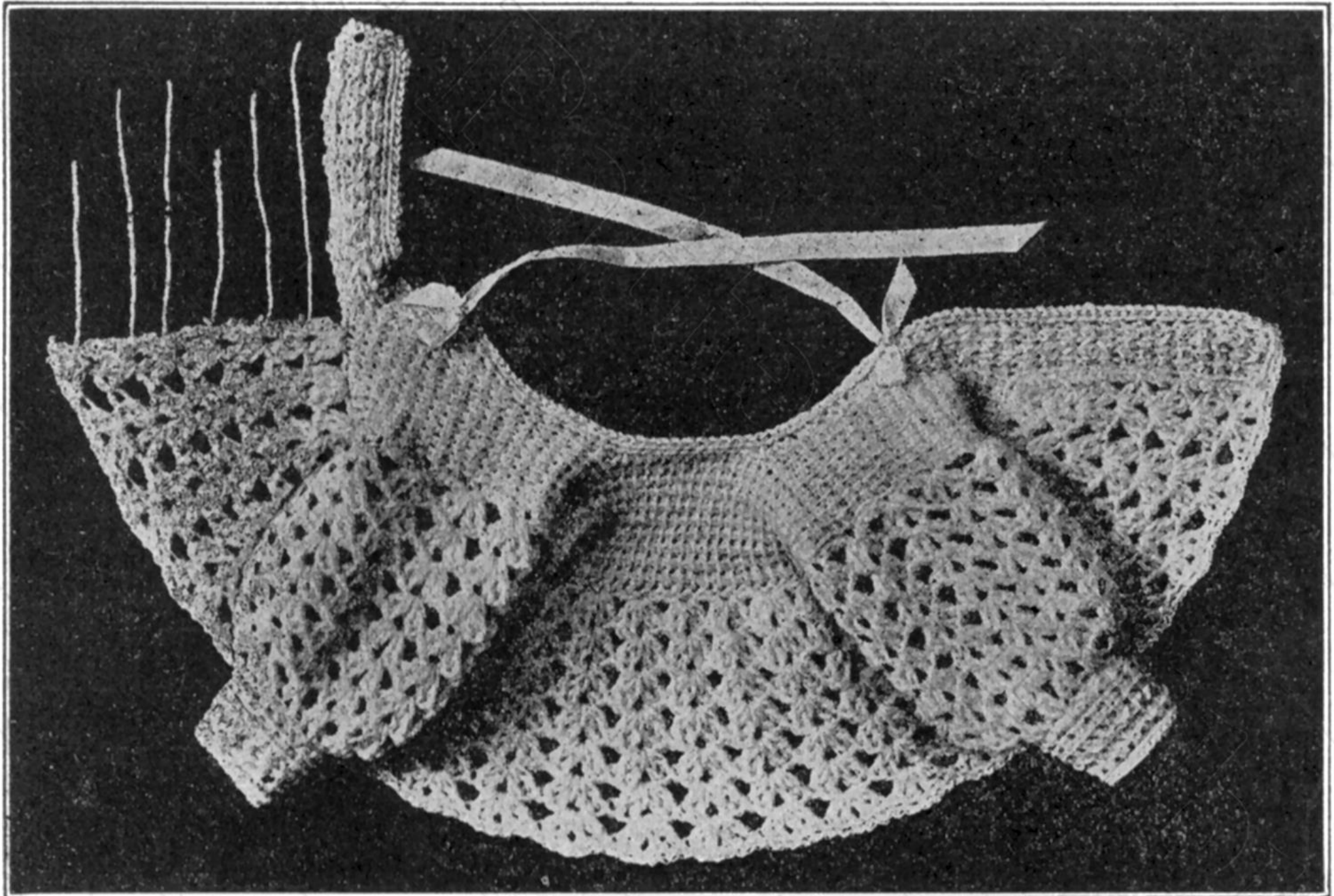

1. Put 1 slip stitch in first stitch.

2. Make 3 chain stitches.

3. Put 1 double crochet in same stitch with the slip stitch,

4. Chain 2.

5. Put 2 double crochets in same stitch.

6. Skip 2 stitches on bottom of yoke, and put 2 double crochets, 2 chain stitches, 2 double crochets in the next stitch. Continue in this way to end of yoke on right side. Break off yarn about 3 inches from the work and pull through the last stitch. The ends are used later to fasten the body of the sacque to the front strips.

7. Second row: Fasten yarn in the middle of the first scallop on the left side, leaving the end hanging. Chain 3. Put 1 double crochet in same stitch. Chain 2.

Put 2 double crochets in same stitch, and continue to other end of yoke, making a scallop in the middle of each scallop.

8. Continue in this way until the body is as long as the strip in front.

9. Thread a long-eyed needle with the end of yarn hanging from the first scallops, and catch it to the front strip with an over-and-over stitch. Cut off yarn.

Continue to fasten fronts to scallops in this way until they are fastened down the full length of the fronts.

To Make the Sleeve:

1. Fasten yarn at corner of armhole. Chain 3, and make a scallop (as in body part of sacque) in first stitch.

2. Skip 4 of the slip stitches on the edge. Make a scallop in the next stitch.

Continue in this way around the armhole.

3. Join last and first scallop with slip stitch.

4. Chain 3 and make another round of scallops and join.

5. Continue to make rounds of scallops until there are 7 rows.

6. On the next row, chain 3. Put 2 double crochets in the middle of each scallop in the row below,

7. Next row: Chain 3. Put 1 double crochet in each double crochet of row below. Break off and fasten yarn.

Make other sleeve like this one.

To Make Bands for Sleeves:

1. Chain 6, and make a strip of afghan stitches 14 rows long.

2. Finish all around strip with slip stitch.

3. Sew ends of band together, and slip it over the end of the sleeve, putting the seam to the seam of the sleeve, and sew in place with end of pink wool.

Trimming.—With pink silk, make a row of slip stitches all around the edge of the sacque, and ends of the sleeves.

Thread a zephyr needle with two threads of the silk, and make cross stitches on the front strips, and around the strips at ends of sleeves.

Fasten pink narrow ribbons at neck to tie.

INFANT DOLL'S CROCHETED CAPE AND HOOD*

(See picture opposite page 136)

Material: Two-fold Saxony wool. Crochet silk (mercerized) for trimming. Bone crochet needle, No. 2.

Directions:

To Make the Hood.

1. With the Saxony, make 3 chain stitches.

2. Join them in a ring with a slip stitch.

3. Make 3 chain stitches, and make 16 double crochets in the ring.

4. Join the last double crochet with the top of the 3 chain stitches with a slip stitch. This makes the first row.

*This piece is difficult for children to make.

5. Second row: Make 3 chain stitches and put 2 double crochets in each double crochet of the first row. In making this garment, take up back loop of the stitch only. Join as in direction No. 4 (bottom of page 236).

6. Third row: Chain 3; that is, make 3 chain stitches. Put 1 double crochet in the first double crochet in the row below. Put 2 double crochets in the second double crochet. Continue in this way to the end of the row, and join as in direction No. 4.

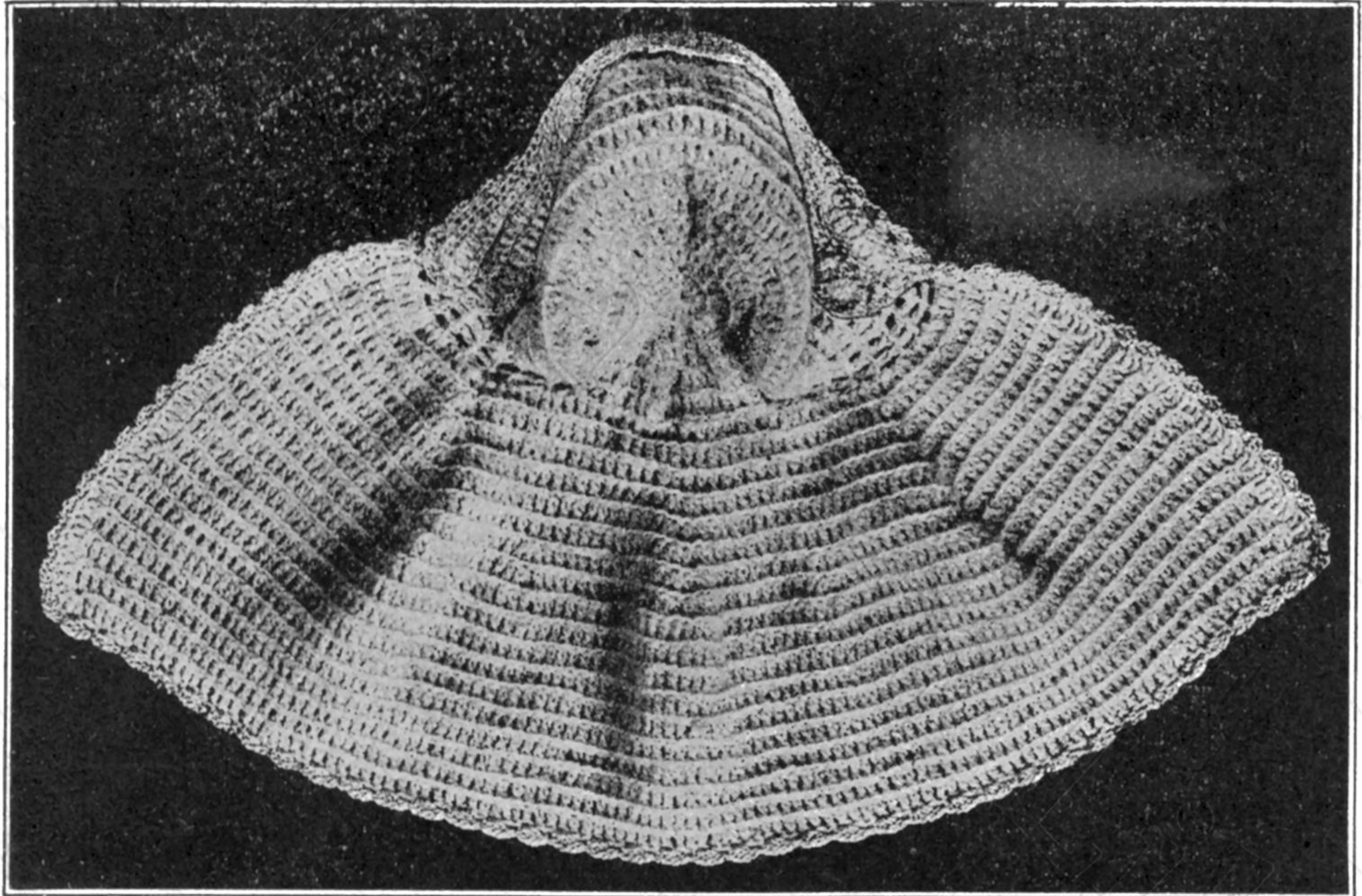

CAPE AND HOOD

7. Fourth row: Chain 3 and put 2 double crochets in every third stitch. Put 1 double crochet in the stitches between.) Do this to the end of the row and join.

8. Fifth row: Chain 3, and put 2 double crochets in every fourth stitch. Join.

9. Sixth row: Chain 3 and put 1 double crochet in each double crochet of the row below. Join and break off and fasten the yarn.

10. Seventh row: Fasten end of wool at the ninth stitch and make 3 chains. Put 1 double crochet in each stitch of row below, leaving 16 stitches without any stitches taken in them; that is, leave 8 stitches on each side of the joining. This will be the back of the neck.

11. Make 8 rows in all, putting 1 double crochet in each double crochet of row below, breaking off and fastening the yarn at end of each row. Begin the new row each time at the right side of the cap.

There is a turned-back facing around the face of the doll.

To Make the Facing:

Holding the wrong side of the cap toward you, make 4 rows of double crochet in the same way as in directions Nos. 10 and 11. Nothing more is to be done to this facing until after the cape is made.

TO MAKE THE CAPE

This work is all done on the right side, holding cap toward you.

1. Starting at the right-hand corner of the neck, make 1 row of double crochet along the bottom edge of the cap. Break off and fasten yarn.

2. Second row: Fasten yarn at right end and make this row of double crochet, putting 3 double crochets in the fifteenth stitch from each end. These increases make the fulness over the shoulders,

3. Third row: Make this row of double crochet, putting 3 double crochets in the middle stitch of the increases in direction No. 2.

4. Fourth row: Make in same way, increasing as in No. 3. Also increase by making 2 double crochets in each of 2 stitches in the middle of the back.

5. Fifth and sixth rows: Same as fourth row.

6. Seventh row: This row is increased in the shoulders and middle of back in the same way as before, but more fulness is given by making 2 double crochets in the 2 middle stitches between the shoulder and the back on each side.

7. The eighth row is made in the same way as the seventh row.

8. Make 9 rows without increasing.

9. To fasten the loose ends of wool, thread them into a long-eyed needle and run the ends back into the work.

10. Starting at the neck at the left side, holding the outside of cape toward you, make single crochets in the ends of the first 2 rows of double crochet.

11. Make double crochet all around the cape except at the corners, where you will put 3 double crochets.

12. When you reach the first 2 rows on the right-hand side of the cape at neck, make single crochet as in the No. 10.

13. Put 1 single crochet in each stitch around the face holding the turn-back flat against the cap.

To Trim.—Fasten the pink silk at the left side of the neck, and put 1 single crochet, 2 chains and 3 double crochets in the first stitch.

2. Skip 2 stitches, and put 1 single crochet, 2 chains, and 3 double crochets in the third stitch.

3. Continue to do this all around the cape and the face of the hood or bonnet, and then around the edge of the turn-back,

4. Holding the face of the hood toward you, put a single crochet in the front loop of each stitch all around the first row of double crochet in the turn-back.

5. Do the same to the other 2 rows of the turn-back.

DOLL'S CROCHETED COACH COVER

(Coffee Bean Stitch)

Material: White four-fold Germantown zephyr with pink four-fold Germantown zephyr for trimming. Bone crochet hook, No. 6.

Directions:

NOTE.—In doing this work, make loose stitches.

TO MAKE COFFEE BEAN STITCH

1. Chain 50; that is, make 50 chain stitches.
2. (a) Skip 2 chains, and put the hook through the third chain stitch.
(b) Wrap (throw yarn over hook) and pull the hook through the stitch.
(c) Wrap. Put hook through the same chain stitch: Wrap, and pull hook through the stitch.
(d) Wrap. Put hook through the same chain stitch. Wrap, and pull hook through the same stitch. There will now be 6 stitches on the crochet needle.
(e) Throw yarn over hook, and draw it through the 6 stitches on the needle.

3. Chain 1.
4. Skip 1 chain stitch in the chain first made (see direction No. 1 above) and repeat direction No. 2. This will make another bean stitch.

5. Continue to make bean stitches to the end of chain, making 25 beans in all. Turn the work.

6. Second row: Draw a loop through the second stitch from the needle.

Throw yarn over hook and proceed to make another bean. Chain 1, and skip 1 stitch and continue in this way to the end of the row.

Make in all—

- 6 rows of white
- 4 rows of pink
- 22 rows of white
- 4 rows of pink
- 6 rows of white

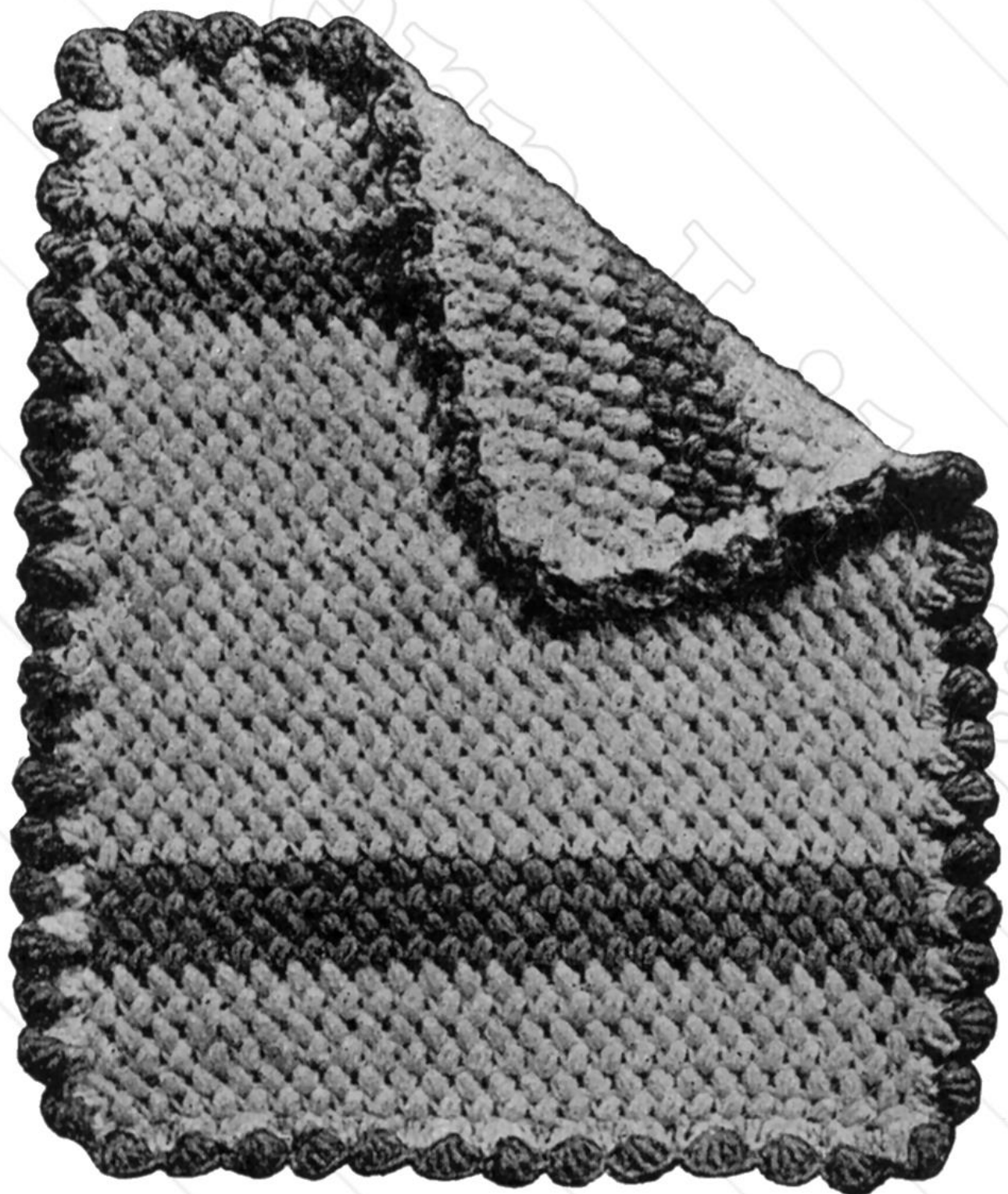

To Make the Scallops:

1. Fasten the white wool in the first stitch of the top with single crochet.
2. Put 5 double crochets in the next stitch.
3. Skip 1 stitch and put 1 single crochet in the next stitch. (This will hold the scallop down.)
4. Skip 1 stitch and put 5 double crochets in the next stitch. Fasten scallop down with 1 single crochet as in direction No. 3. Continue to make scallops all around the cover. Break off white yarn and fasten.
5. Attach pink yarn, and put 1 single crochet in the white single crochet.
6. Put 5 double crochets around the third stitch of the white scallops. The double crochets are put around the third stitch as in making Doll's Crocheted Hat, page 207.
7. Fasten scallop down with single crochet in the single crochet between the white scallops.
8. Continue to make scallops this way all around the cover. Break off the yarn, and fasten the end.

DOLL'S CROCHETED SPORTS HAT

(See picture opposite page 72)

Material: Rose pink wool floss, Gray Angora or Teazle wool for trimming.
Bone crochet hook, No. 3.

Directions:

1. Chain 3; that is, make 3 chain stitches.
2. First row: Put 6 single crochets in second chain stitch. Do not join.
3. Second row: Put 2 single crochets in each of the 6 single crochets, taking up both loops.
4. Third row: Put 2 single crochets in the first stitch, 1 single crochet in the next stitch. Continue around row.
5. Fourth row: Put 2 single crochets in the first stitch, 1 single crochet in each of the next 2 stitches. Continue around row.
6. Continue to widen in this way until there are 11 stitches in each section, or 66 stitches in the row.
7. Make 6 rows without increasing.
8. Make 10 single crochets; skip 1 stitch and continue to do this until there are but 48 stitches.
9. Turn, and work on the wrong side of the hat.
10. Make 1 row of single crochet without increasing.
11. On the next 2 rows, increase in every third stitch, as in direction No. 5.
12. Make 1 row of single crochet without increasing.
13. Finish off the pink by taking 2 slip stitches.
14. Fasten on the trimming wool, and make 1 single crochet in each stitch all around for 2 rows.
15. Make 1 row of slip stitches. Break off and fasten yarn.



DOLL'S CROCHETED BREAKFAST CAP

(See page 87)

Material: Pink or white, or pink and white, or light blue and white luster cotton. Steel crochet hook No. 7. 1 yard "baby" ribbon to match cap.

Directions:

The work is begun in the center of the top.

1. Chain 5; that is, make 5 chain stitches. Join in a ring with slip stitch. Chain 4.

2. First row: Make 20 treble crochets in the ring (see page 228). Join last stitch to top stitch of chain with slip stitch.

3. Second row: Chain 4. Put 1 single crochet into each treble crochet with 4 chain stitches between the single crochet, thus making a loop of the chain stitches.

4. Third row: Chain 4. Make 1 single crochet in each chain loop with 4 chain stitches between.

5. Fourth row: Same as third row.

6. Fifth and sixth rows: Chain 5. Make 1 single crochet in each chain loop, with 5 chain stitches between.

7. Seventh and eighth rows: Chain 6. Make 1 single crochet in each chain loop with 6 chain stitches between.

8. Ninth row: Chain 4. Make 1 single crochet in the loop of the row below. Chain 4. Make 1 single crochet in the first single crochet of row. Chain 4. Make 1 single crochet in next loop. Chain 4. Make 1 single crochet in next single crochet. Continue around the row.

9. Tenth row: Chain 4. Make 1 single crochet in each loop to end,

10. Eleventh and twelfth rows: Like tenth row.

11. Thirteenth row: Chain 4. Make 1 double crochet in chain loop. Chain 1. Make 1 double crochet in first single crochet. Chain 1. Make 1 double crochet in next chain loop. Chain 1. Make 1 double crochet in next single crochet. Continue to end of row.

12. Fourteenth row: Chain 4. Put 1 double crochet in each space of thirteenth row with 1 chain stitch between and join last stitch to top of the chain 4 with a slip stitch.

13. Fifteenth row: Chain 1. Make 1 single crochet in each double crochet of fourteenth row.

14. Sixteenth row: Chain 3. Make 1 double crochet in each single crochet of fifteenth row. (When the cap is finished run ribbon through these stitches.)

15. Seventeenth row: Chain 4. Make 1 single crochet in the second double crochet of sixteenth row. Chain 4. Make 1 single crochet in the fourth double crochet. Continue to end of row.

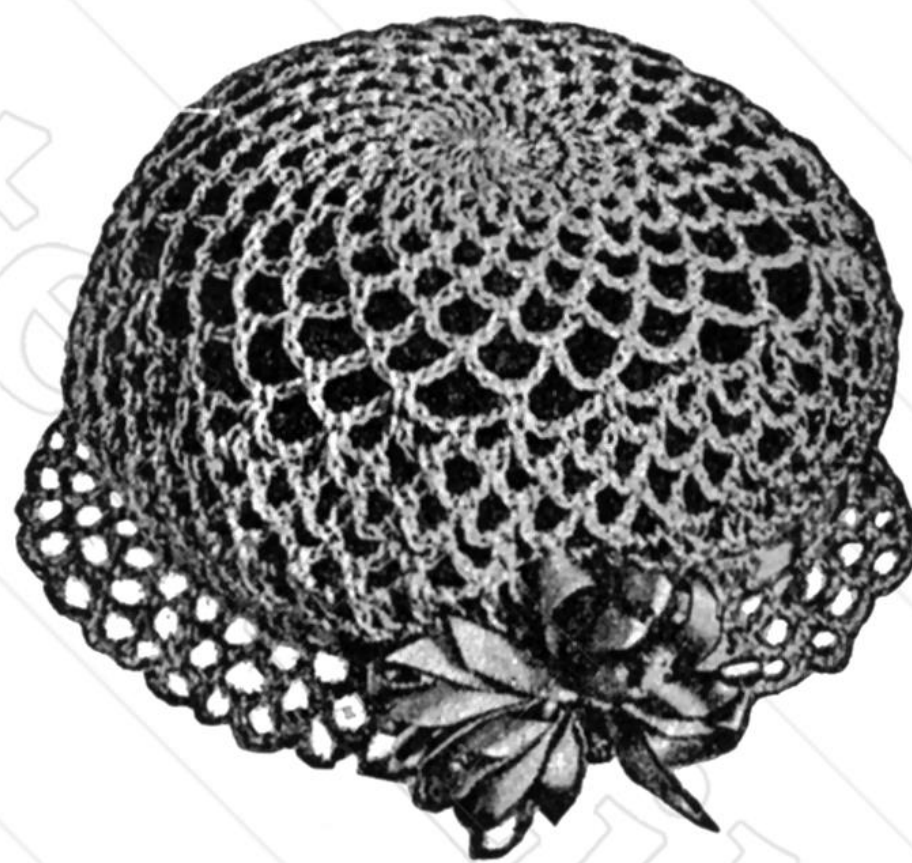

16. Eighteenth and nineteenth rows: Chain 5. Make 1 single-crochet in each chain loop of previous row with 5 chain stitches between. Break off and fasten thread.

Trim with ribbon rosette.

DOLL'S CROCHETED GARTERS

(See picture opposite page 40)

Material: Pink or light blue mercerized crochet cotton. (In ordering this material, mention what you are going to make, so that you will be given the right size of thread.) Steel crochet hook, No. 9.

Directions:

1. Chain 10; that is, make 10 chain stitches.
2. Put 2 double crochets and 1 chain and 2 double crochets in the fourth stitch from the needle.
3. Chain 5.
4. Put 2 double crochets and 1 chain and 2 double crochets in the end chain stitch.
5. Chain 3 and turn.
6. Put 2 double crochets and 1 chain and 2 double crochets between the second and third double crochet in the cluster below. (This cluster was made by direction No. 4 above.)
7. Chain 5, and repeat direction No. 6 in the next cluster below.
8. Repeat directions No. 5, 6, 7, again. This will make 3 rows.
9. On the fourth row, make the cluster (No. 4). Chain 2. Make 1 single crochet around the 2 rows of 5 chains below.
10. Chain 2 and continue with the clusters, catching chains together in every fourth row. Make work long enough to cover the doll's elastic garter very loosely.
11. Run rubber garter through the crocheted work and fasten ends of garter. Sew a ribbon bow over the joining,

A CHILD'S GARTER

is made in the same way, using a few more stitches in each row across.

DOLL'S CROCHETED SHOPPING BAG

(See picture opposite page 104)

Material: Ecreu crochet cotton, No. 5. Two brass rings to fit doll's wrist. Steel crochet hook No. 7.

Directions:

This work is begun at the bottom of the bag.

1. Chain 25; that is, make 25 chain stitches.
2. Using 1 chain to turn, make 24 single crochets in the chain. Put 2 more single crochets in the last stitch.
3. Make 1 single crochet in each stitch on the other side of the chain, putting 2 single crochets in end stitch.

4. Now work around and around without joining the rows. Chain 3, skip 1 stitch, make 1 single crochet in the second stitch. Continue doing this around the first row.

5. On the next row, chain 3, make 1 single crochet around the chain 3 of the row below. Continue doing this until there are 13 rows.

6. On the fourteenth row, work half way around. Make 3 chains to turn, and put 1 single crochet in the first chain loop. Chain 3, and continue across, making stitches as in direction No. 5. Make 5 rows. This will make the division which forms the opening.

7. Next row: Chain 3. Make 1 double crochet in each chain loop, with 1 chain between.

8. Next row: Chain 3. Make 1 double crochet in each double crochet of row just made.

9. Last row: Chain 1. Make 1 single crochet in each double crochet of row below. Do not break off the thread.

To Fasten Bag to Handles:

1. With the last stitch made on the needle, put hook through one of the brass rings which will be used as a handle. Very nearly fill the ring with single crochet. Fold the ring down inside the bag, and make single crochet through the ring and top of bag, putting 1 single crochet in each stitch.

This will entirely cover the ring, and attach it to the bag at the same time, and will also make a neat finish on the right side of the work.

2. Break off and fasten end of thread.

3. To make other side of opening.—Start at right-hand side of opening. Make 3 chains. Put 1 single crochet in first chain loop, and continue to work in the same way as you made the first side.

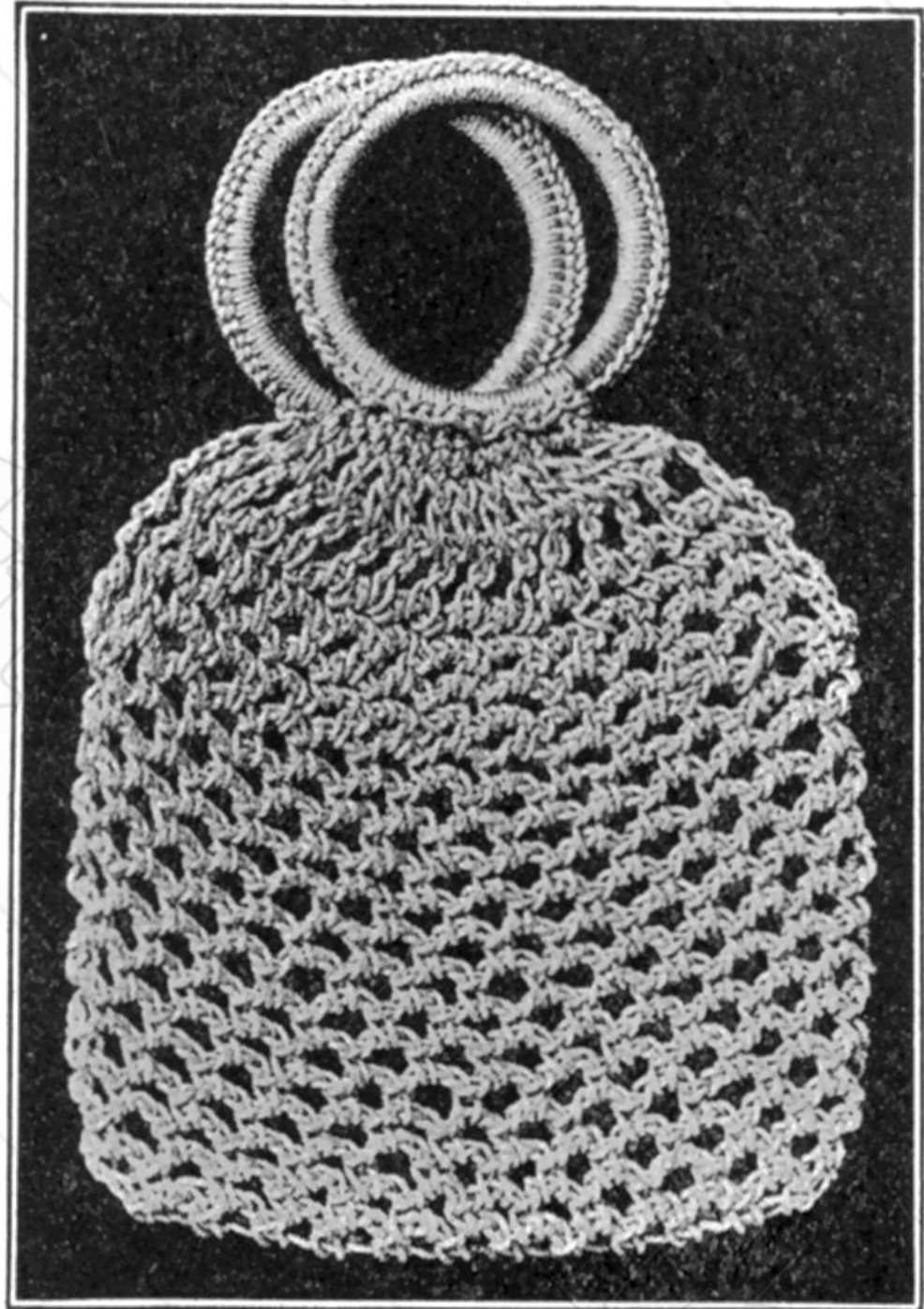

DOLL'S SHOPPING BAG

DOLL'S CROCHETED SPORTS SWEATER

(See frontispiece)

Material: Burnt orange double floss with black double floss for trimming three small wooden button molds. Bone crochet hook, No. 2.

Directions:

To Make Front:

1. With orange floss, chain 25; that is, make 25 chain stitches.
2. Make 24 single crochets. Chain 1 to turn.

3. Taking front thread of stitch only, put 1 single crochet in each of 24 single crochets, and add 1 single crochet in the last stitch. Chain 1 to turn.

4. Continue in this way (No. 3), adding 1 single crochet at neck end until there are 27 stitches,

5. On the next row add 4 chains after making 27 single crochets.

6. Put 1 single crochet in each of 3 of these chains, and 1 single crochet in each of the 27 single crochets, making 30 single crochets in all.

7. Continue to make rows of 30 single crochets until there are 13 rows from the beginning.

8. On the fourteenth row, make 20 single crochets. Make 8 rows of 20 single crochets for under arm.

9. On the twenty-third row, add 11 chain stitches. Use 1 chain to turn, and



DOLLS SPORTS SWEATER

make 10 single crochets in the chain stitch.—also 20 single crochets in the single crochets (see No. 8) under arm.

10. Make 21 rows of the 30 stitches for the back.

11. On the next row (the forty-fourth) make 20 single crochets for 8 rows under arm.

12. On the next row (the fifty-second) add 11 chain stitches. Use 1 chain to turn. Make 10 single crochets in the chain and 20 single crochets in the under arm stitches.

13. Make 7 rows of the 30 single crochets.

14. On the next row make 27 stitches. (Be sure to make this row from the bottom upward.) Make 1 chain to turn.

15. Skip the first single crochet at the neck, and make 26 single crochets.

16. Continue to decrease 1 single crochet at the neck until you have only 24 single crochet stitches in the row.

This finishes the body of the sweater.

17. Sew 7 rows of the front and back at the shoulders to form armholes. (See picture, page 130.)

Border around the Sweater:

1. Starting at the left side of the neck, holding outside of the sweater toward you, put 1 single crochet in each stitch all around the sweater until you come to the right side of the neck, except at the corner stitches at the bottom, in which put 3 single crochets.
2. Chain 1 to turn, and work back to the starting point in the same way.
3. Then put one row of slip stitches all around sweater.

To Make the Buttons:

Make 5 buttons of orange floss just as you made the buttons on the doll's pink sweater (see page 205).

Thread a long-eyed needle with black floss and decorate the buttons with cross stitches around the edges.

To Make the Collar:

1. With black floss, chain 31. Use 1 chain stitch to turn.
2. Make 30 single crochets. Make 1 chain.
3. Make 6 rows of 30 single crochets, taking both threads.
4. Make 16 rows of 15 single crochets.
5. Make 6 rows of 30 single crochets. (Add chain stitches as for lengthening in No. 9 above.)
6. With two strands of the black floss put 1 row of single crochet across the bottom edge of the back of the collar.
7. With single black floss put 1 row of slip stitches all around the collar.

To Make the Sleeve:

1. Chain 9.
2. Make 8 single crochets. Chain 1.
3. Second row: Put 2 single crochets in the first stitch. Make 1 single crochet in each stitch to the end of the row. Chain 3 to turn.
4. Third row: Make 1 single crochet in each of the 2 chains, and make single crochet to the end.
5. Fourth row: Put 2 single crochets in the first stitch; single crochet to the end of row. Chain 5. Turn.
6. Fifth row: Put 4 single crochets in the chain, and single crochet to end of the row. 1 chain.
7. Sixth row: Put 2 single crochets in the first stitch; single crochet to end of row. 1 chain.
8. Seventh row: Make 17 single crochets, 1 chain.



9. Eighth row: Put 2 single crochets in the first stitch; single crochet to end. Make 1 chain.

10. Make 6 more rows of 18 stitches.

11. On the fifteenth row, skip the stitch next to the last. Make 1 chain.

12. Sixteenth row: Make 17 single crochets and 1 chain.

13. Seventeenth row is the same as the fifteenth row.

14. Eighteenth row is 16 single crochets and 1 chain.

15. Nineteenth row: Put a slip stitch in each of the first 4 stitches; single crochet to the end of the row, skipping the next to the last stitch. Chain 1.

16. Twentieth row: Make 11 single crochets and 1 chain.

17. Twenty-first row: Make slip stitch in the first 2 stitches; single crochet to the end of row, skipping next to the last stitch. Chain 1.

18. Twenty-second row: Make 8 single crochets. Sew up the sleeve.

With orange floss, put 2 rows of single crochet around the hand, taking both threads of stitches.

Add 2 rows of black single crochet and 1 row of black slip stitches.

To Make the Belt:

1. Chain 5.

2. Make 4 single crochets. Chain 1 to turn.

3. Taking both threads, make 4 single crochets and 1 chain to turn until the belt is the length desired. (About 28 rows.)

Sew the sleeves in the armholes as in making Teddy Bear Sweater (see page 133).

Sew buttons in place and make loops as in making Teddy Bear Sweater.

Sew belt at waist line under arm, sewing a button on each end.

Sew the collar to the neck of the sweater.

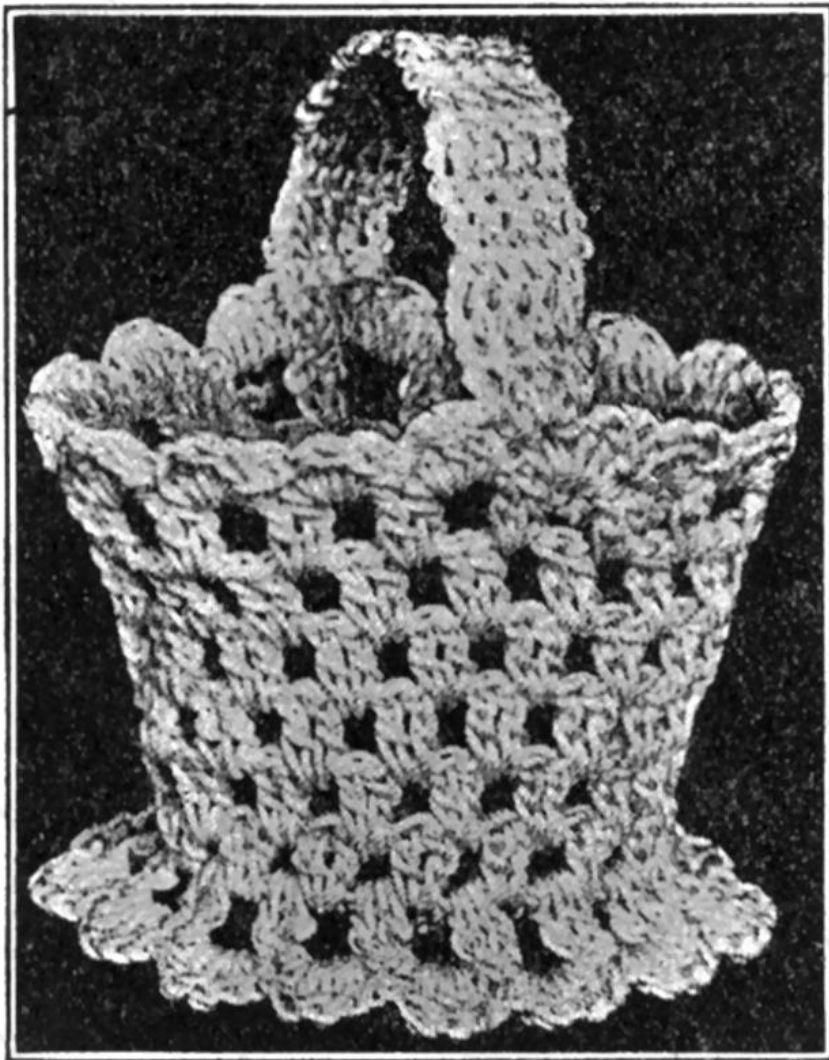

DOLL'S CROCHETED FLOWER BASKET*

(See picture opposite page 230)

Material: White or tan crochet cotton No.

10. Steel crochet hook No. 7.

Directions:

To Make Bottom of Basket:

1. Chain 5; that is, make 5 chain stitches.

Join into a ring with a slip stitch.

2. Chain 5.

3. Make 15 treble crochets in the ring with 1 chain stitch between each treble crochet. Join the last treble crochet into the fourth chain stitch (see No. 2) with slip stitch.

4. Second row: Chain 4. Make 1 double crochet in the space between the first 2 treble crochets, Chain 2. Make 1 double crochet

* This piece makes a pretty bonbon holder for the table.

in next space. Make 2 chain stitches. Continue in this way around the row. Join (with slip stitches) the last of the 2 chain stitches into the third chain of the 4 chain stitches.

5. Third row: Chain 3. Put 2 double crochets in the first space between first 2 double crochets in previous row. Make 2 chains. Put 2 double crochets in the next space. Make 2 chains. Continue around the row, and join the last chain with the top of the 3 chains.

To make the Scallops:

6. Make 1 single crochet, 3 double crochets, 1 single crochet in each space between double crochets in the row below.

To Make the Sides of the Basket:

1. Turn the under or wrong side of the bottom of the basket toward you. Bend down the scallops under the thumb.

2. Chain 3.

3. Put hook through the top of the first double crochet made in the second row. (See No. 4, page 246.) Fasten chain which is on needle with a slip stitch. (See picture.)

4. Chain 3. Put 2 crochets in each space between the double crochet in the second row. Join last and first stitch with slip stitch.

5. Chain 3.

Put 2 double crochets in the space between the first two clusters of double crochet in the row below. Chain 1.

Continue to end of row. Join with slip stitch.

6. Make 3 more rows in the same way.

7. The next row is made in the same way, except that 2 chains are put between the clusters of stitches.

8. Finish the top of sides with scallops like the ones on the bottom of the basket. (See No. 6.)

To Make the Handles:

1. Chain 3.

2. Put 4 double crochets at the top of the first two scallops. (See picture.)

3. Chain 3. Turn. Make 1 double crochet in each of the 4 double crochets.

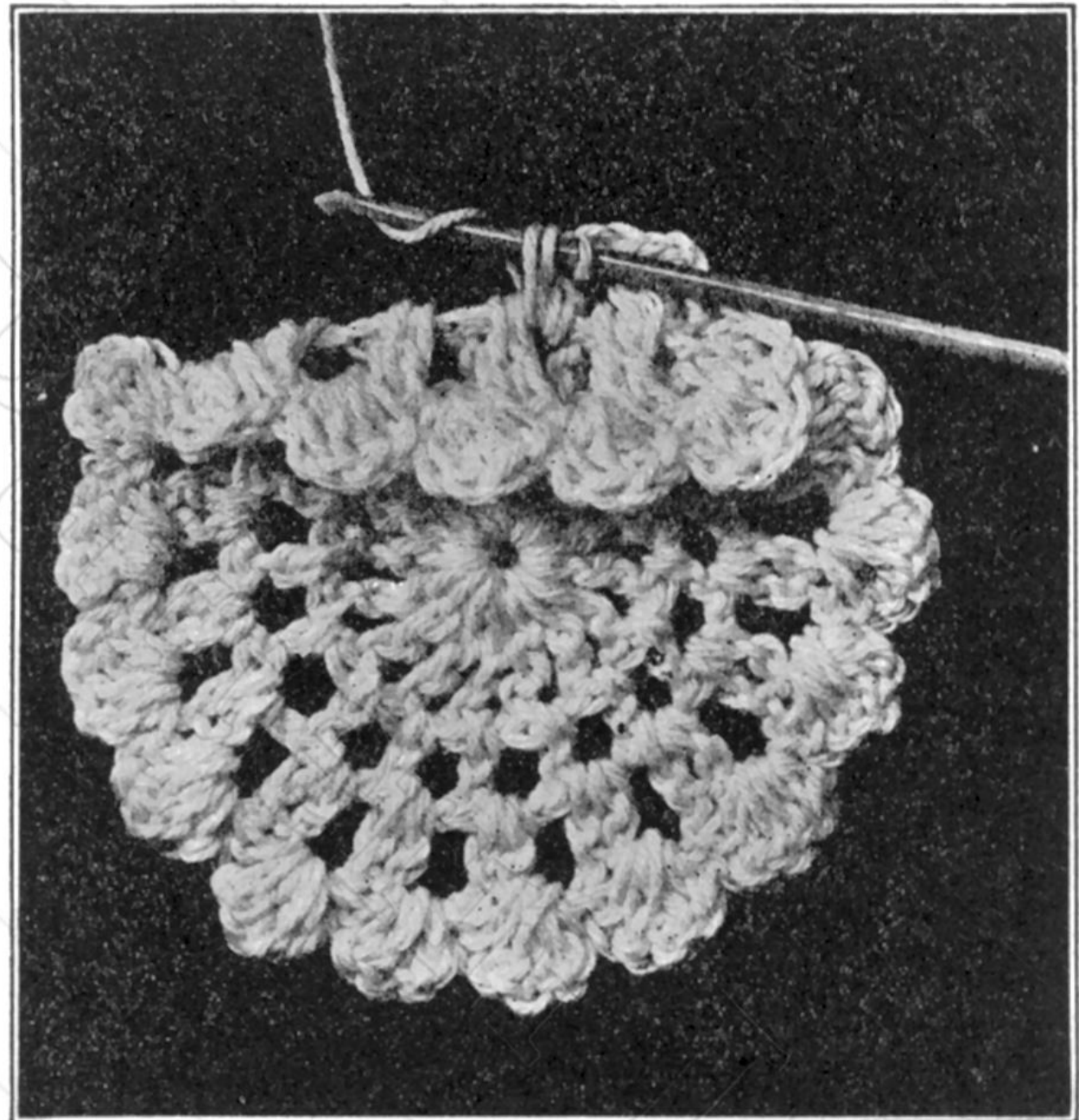

4. Repeat No. 3 until handle is about 12 rows long, or as long as desired.
5. Fasten end to opposite side of basket with slip stitch.
6. Run ribbon through the spaces in the sixth row of sides, and tie in a bow.

GIRL'S CROCHETED HAND BAG

(Crazy Stitch)

(See picture opposite page 104)

Material: Heavy mercerized Old Blue crochet cotton, about No. 5. Steel crochet hook, No. 3.

Directions:

This bag is made with

CRAZY STITCH

1. Chain 28 stitches; that is, make 28 chain stitches.
2. In the fourth stitch from needle, put 3 double crochets.
3. Skip 3 chains and put 1 single crochet, 2 chains, 3 double crochets, in the fourth chain stitch.
4. Skip 3 chains and repeat the cluster to the end of the chain, fastening the last cluster in the end stitch of the 35 chain stitches with a single crochet.

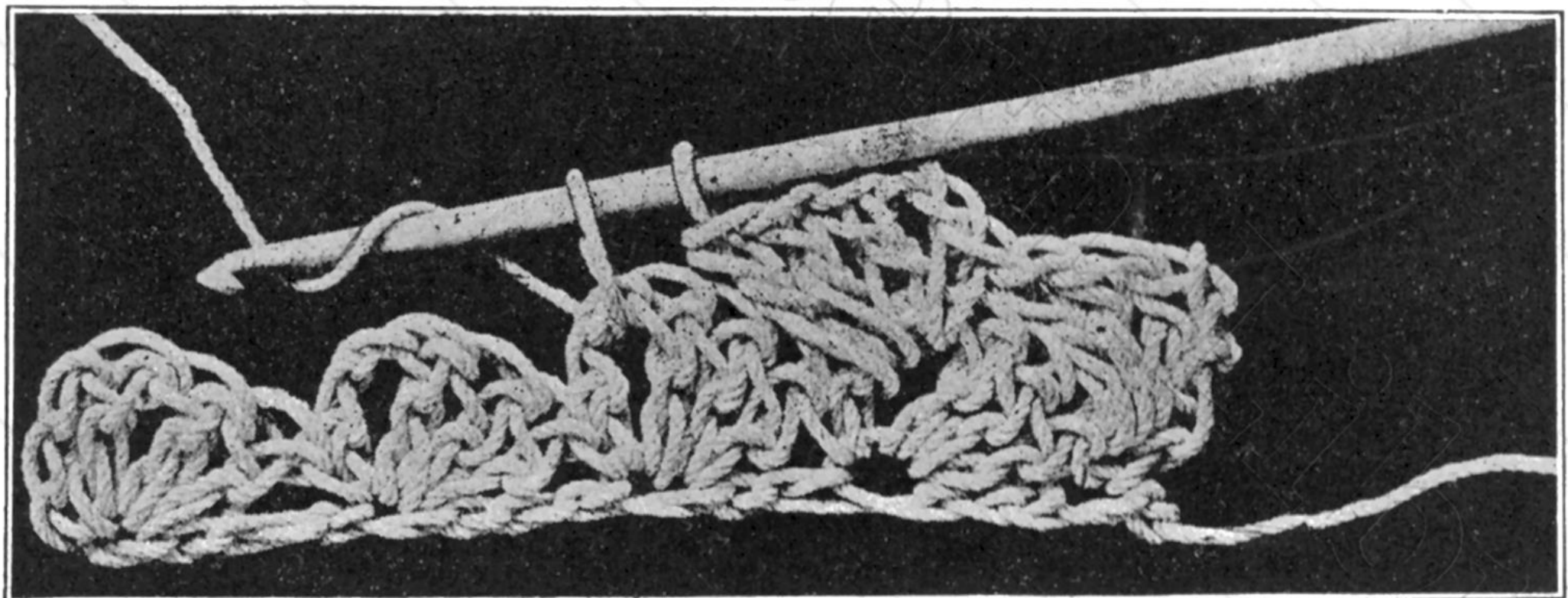

5. Second row: Chain 3, and turn the work. Make 3 double crochets in the single crochet that fastened the last cluster to the end of the chain. (See picture.)
6. Put 1 single crochet, 2 chains, 3 double crochets between the third double crochet and the 2 chains of the row below. (See picture.)
7. Continue in this way, making clusters until there are 9 rows. Break off and fasten thread. This makes one side.
8. To make other side. Fasten the cotton in the last chain stitch of the chain first made. (See No. 1.)
9. Make 9 rows of clusters.
10. Fold, and crochet sides together with single crochets.
11. Make 1 row of clusters all around the top of the bag.

12. Make 1 single crochet in the chain stitches in the first cluster of the row of clusters just finished.
13. Make 3 double crochets in the single crochets between the clusters.
14. Put 1 single crochet in the chain of the next cluster.
15. Repeat Nos. 12, 13, 14 around top.

To Make Runner Spaces:

1. Chain 3.
2. Put 1 double crochet in the first double crochet of the first scallop. Chain 1.
3. Put 1 double crochet in the third double crochet of scallop. Continue No. 2 and 3 around top. Join with slip stitches.

To Make Top Scallops:

1. Make 1 single crochet in the first runner space.
2. Make 2 double crochets in the next space.
3. Make 1 double crochet in the double crochet between the spaces.
4. Make 2 double crochets in the next space.
5. Make 1 single crochet in the next space. This makes 1 scallop.
6. Make scallops in this way all around the top.
7. Make 1 single crochet in the top of the first double crochet of first scallop.
8. Chain 3.
9. Draw a loop through each of the first and second stitches of scallops, and take the 3 loops off the needle as one stitch.
10. Repeat Nos. 8 and 9 around the top.

To Make the Runner:

Cut 3 strands of the cotton about $1\frac{1}{2}$ yards long. Lay side by side and twist as in making trimming for Doll's Crocheted Hat, page 209.

Make 2 runners in this way, and tie a knot in one end of each.

Run them through runner spaces from opposite sides of bag and tie them in hard knots at the ends.

Cut ends even to look like tassels.

BABY'S CROCHETED BOOTEES

Materials: White four-fold Saxony wool. Pink four-fold Saxony wool.
Bone crochet hook No. 3.

Four small flat pearl buttons.

Directions:

(The work is commenced at "B.")

1. With white wool chain 34; that is, make 34 chain stitches.
2. Skip the first chain stitch, and make 1 single crochet in each of the next 16 chain stitches.
3. Put 3 single crochets in the seventeenth stitch, and 1 single crochet in each of the next 16 chain stitches. Make 1 chain to turn.
4. Second row: Taking the back thread of the stitch, make 1 single crochet in each stitch, except the eighteenth stitch. In the eighteenth stitch put 3 single

crochets. The 2 rows now made from a rib, Make 1 pink rib, putting 3 single crochets in the middle stitch at the toe. Make 1 white rib and 1 more pink rib in the same way. Do not break off the yarn. Just let it hang in back of the work, and crochet back edges (from A to B) together with the pink yarn, using slip stitches. Break off and fasten wool.

To Make Sole:

1. Fasten white yarn at the joining place at the bottom, holding right side (outside) of bootee toward you.
2. Make 3 chain stitches. Taking back thread only, make 1 double crochet in each stitch all around edge of sock. Join last stitch to the 3 chains with slip stitches.
3. Second row: Chain 3. Make 1 double crochet in each double crochet of row just made. Join end in same way.

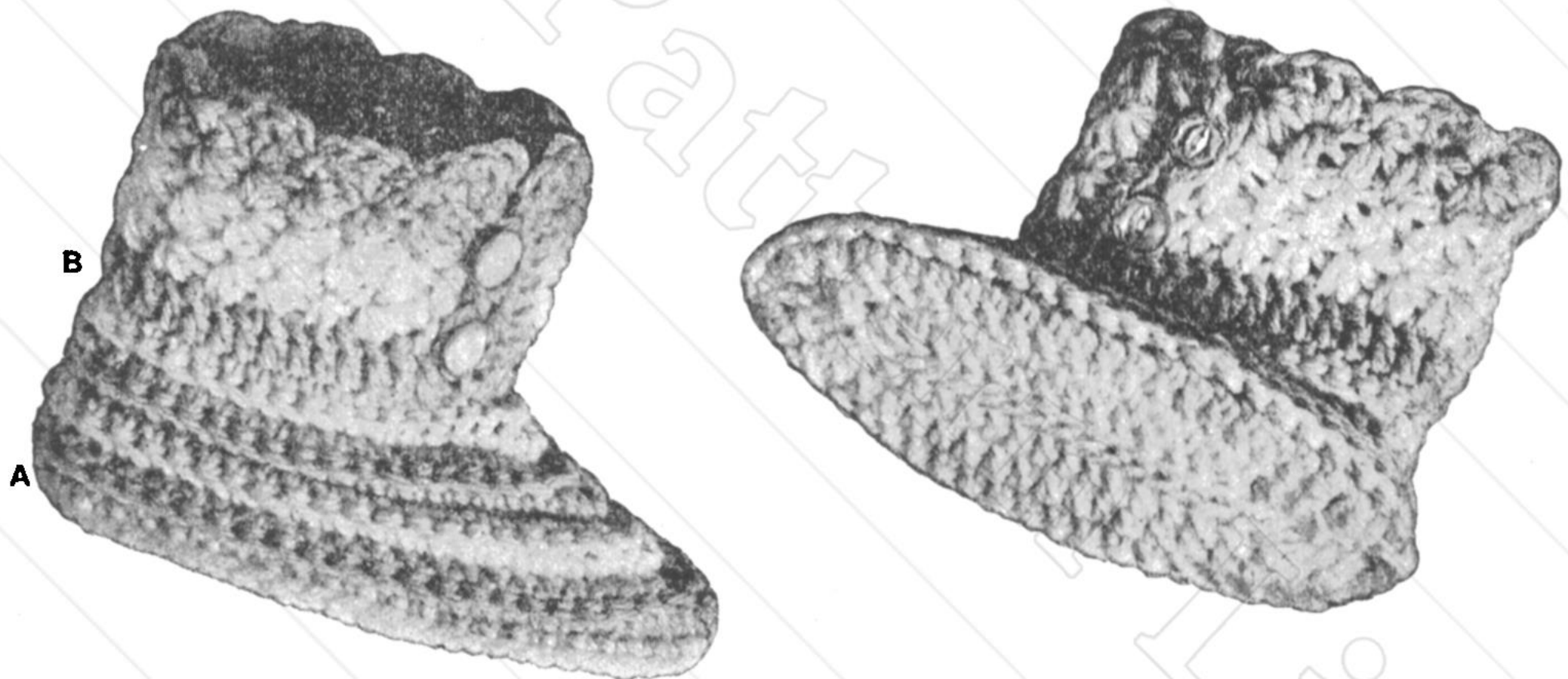

4. Fold sock from toe to heel with right sides in, and join the opening in the sole with slip stitch, catching back threads only of opposite stitches. Break off wool and fasten end. Turn sock right side out.
5. To make finishing edge of sole—hold narrow part of sock toward you, toe pointing toward your left hand. Fasten pink yarn at joining place in back, and make 1 row of single crochet all around sole edge of sock (along the place where the double crochets were first made), taking front thread of stitches of last rib made in vamp, or upper, of sock.

To Make Top of Bootee.

1. Fasten pink yarn in second stitch from middle of the front. (In making sock for the right foot, point the toe toward your right hand with the sole toward you. Point toe toward left hand in making sock for left foot.)
2. Make 1 row of single crochet all around the ledge. Break off yarn and fasten end.
3. Fasten white yarn in top of first single crochet. The top of the sock is made with

STAR STITCH

Practice making this stitch with four-fold Germantown wool. Make 14 chain stitches. Skip 1 chain stitch. Make 13 single crochets in the chain.

1. Make 3 chain stitches. Turn the work. Draw a loop up in each of first two chain stitches of the three chain stitches just made. Draw a loop up in each of the first two single crochets on the edge taking both threads. There will be 5 loops on the needle.

Wrap the yarn around the needle, and pull a loop through all the loops on the needle.

Make 1 chain stitch. This last chain stitch draws all the loops into a little "eye."

2. For the second star stitch, pull a loop through the "eye" of the first star stitch. Pull a loop through the *back* thread of the last loop of the first star stitch. (See "A" in picture below.)

Pull a loop through each of the next 2 single crochets on edge. This will make 5 loops on the needle. Wrap and pull yarn through all the loops on the needle at one time.

Make 1 chain stitch to form the "eye."

3. Repeat direction No. 2 all around sock. Break off and fasten yarn.

4. Second row of star stitches. To make the first star stitch on this row—fasten white yarn into top of first star stitch and make 3 chains.

Draw a loop through each of 2 chain stitches. Draw a loop through the "eye" of the star stitch below (the first one made).

Draw a loop through the *next* stitch at the top of the first star stitch, taking up the 2 threads. This makes 5 loops on the needle. Wrap and draw a loop through all 5 loops, Make 1 chain.

5. In making the next stitch, draw up a loop in the "eye" of the star stitch just made. (See A in picture.) Draw up a loop in *back* thread of the last loop of the star stitch just made. (See B.) Pull a loop through the "eye" of the next star stitch in the row below. (See C.) Pull a loop through under the next *two* threads on the edge of the row below. (See D.) Pull a loop through the 5 loops on the needle. Make 1 chain stitch. Repeat this direction around the sock.

6. Make another row of white star stitches.

7. Make another row of pink star stitches.

To Make the Scallops:

1. Holding the sole of the sock toward

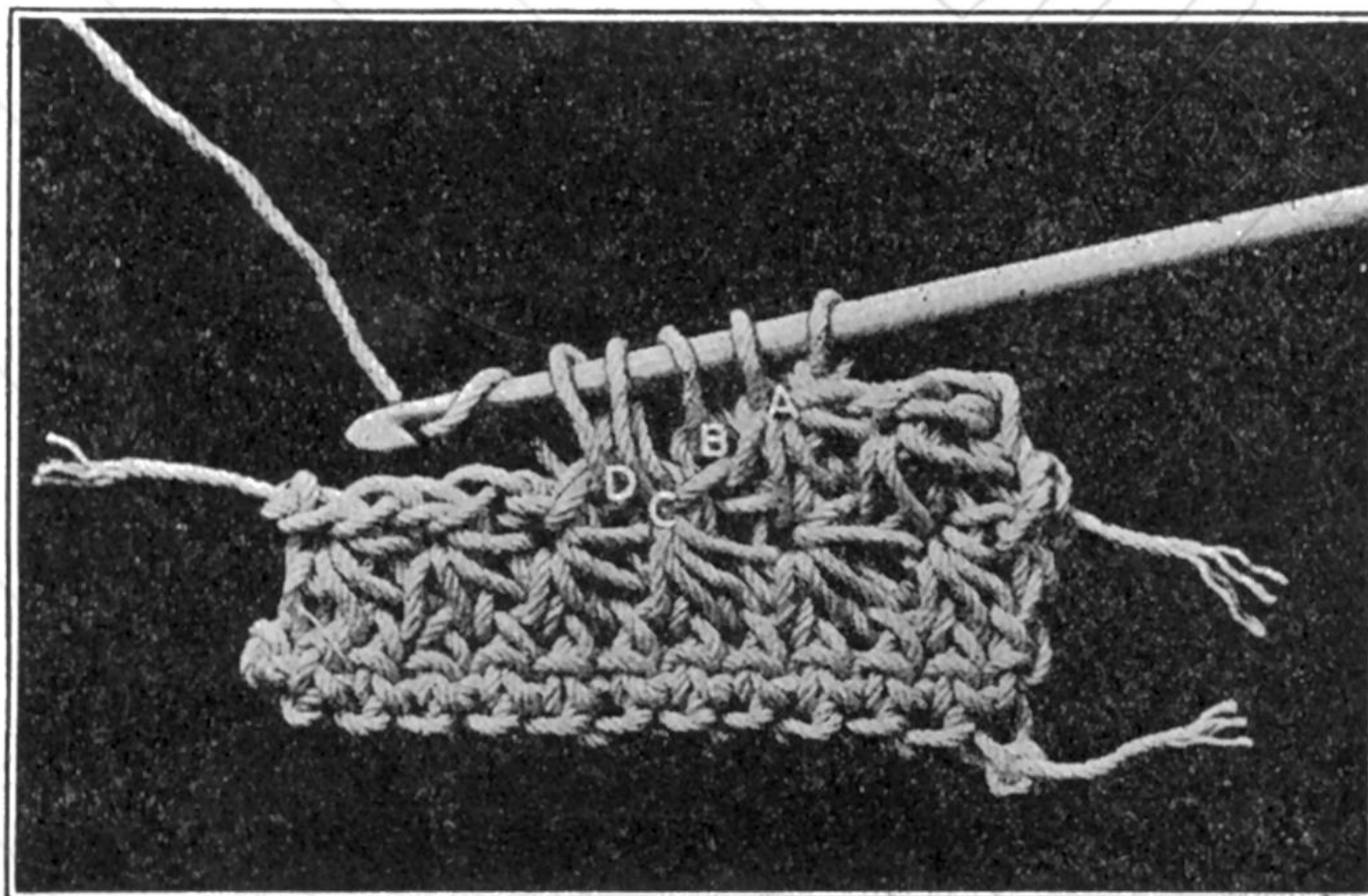

you, fasten the pink yarn at the opening point (near the lower button in the picture).

2. Make a row of single crochet along opening edge to the top.

3. In the corner stitch at the top, make 1 single crochet and 2 chain stitches and 3 double crochets.

4. Make scallop by direction No. 3 in the "eye" of each star stitch around the top.

5. Make a row of single crochet along the other edge of the opening. Break off and fasten yarn.

For Buttonhole Loops:

Fasten pink wool at top edge of the opening, and working toward the sole, make 2 slip stitches.

Make 2 chain stitches. Skip 2 stitches on the edge and make 2 slip stitches. Make another loop in the same way and finish edge of opening with slip stitches. Break off and fasten yarn.

Fasten all ends securely.

Sew two buttons opposite the loops.

BABY'S CROCHETED BALL

(See picture opposite page 230.)

Material: White four-fold Germantown zephyr, Pink Germantown zephyr. Bone crochet hook No. 8.

Directions:

1. With pink yarn, chain 5; that is, make 5 chain stitches.

2. Join into a ring with slip stitches.

3. Put 1 single crochet in the ring.

To Make Curly Stitch:

4. With the stitch now on the needle, put the hook through the ring, draw the yarn through the ring, and make 4 chain stitches. Then the stitches *on the needle* will look like the picture at top of page 253.

5. Do *not* wrap, but draw the last chain stitch through the stitch on the needle.

6. Make 1 single crochet in the ring.

7. Repeat Nos. 4 and 5, being sure to have the loop of chain stitches on the right side of work.

8. Make 5 of the loops of chain stitches in the ring (in all).

9. Second row: Put 1 single crochet in the top of the first single crochet in the ring and a curly stitch in the next stitch.*

10. To widen.—Put the single crochet and the curly stitch in the same stitch. This is

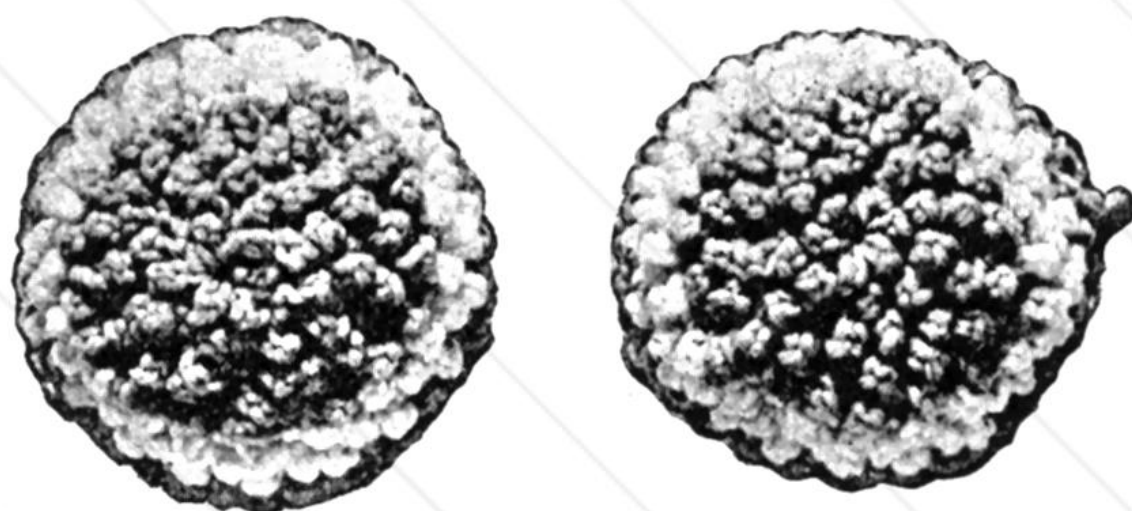

* The curly stitches need not come below each other.

done in about every third stitch until the ball is as wide as you wish to make it.

11. Make 5 rows of pink.
3 rows of white.
2 rows of pink.

This will finish half of the ball.

12. Make another half, and sew the two halves together, leaving about 2 inches open for filling.

13. Fill with raw cotton. Bury in the cotton several little brass bells. Or fill with odds and ends of left-over yarn.

14. Finish sewing together.

Directions:

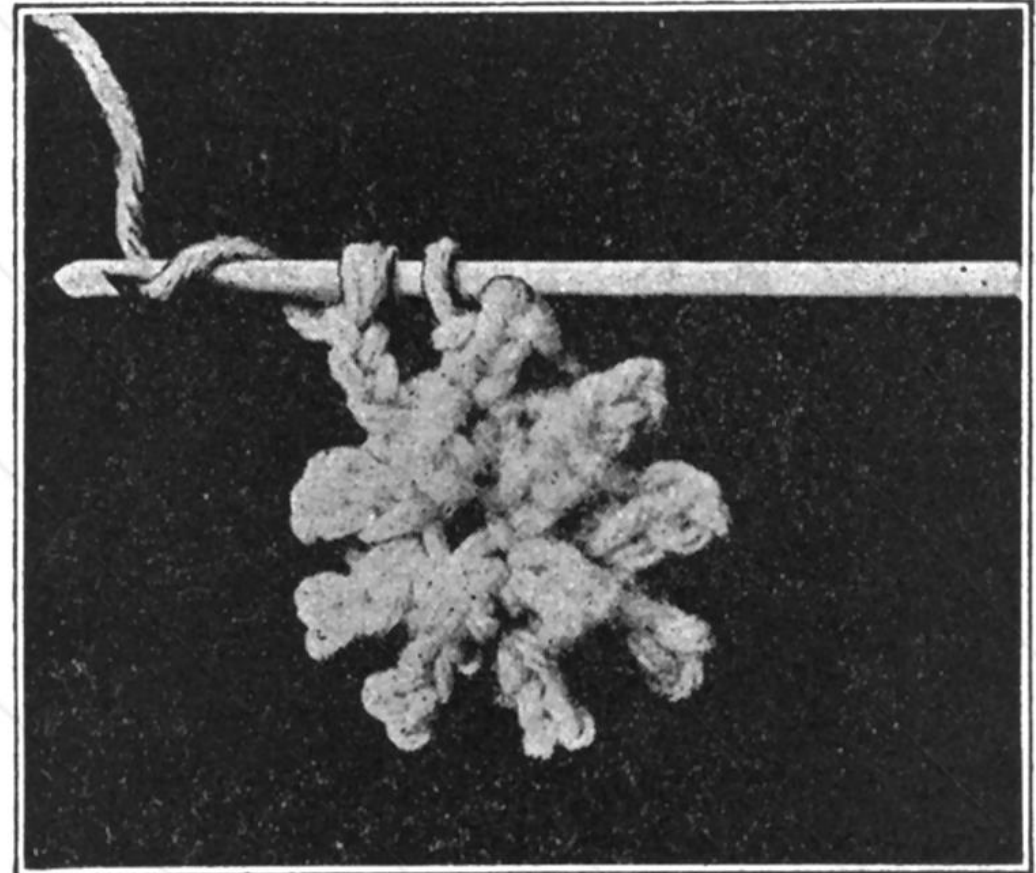

CURLY STITCH

LADY'S CROCHETED NECKLACE

(See picture opposite page 200)

Material: Mercerized cotton, or silk—any color desired, 6 glass beads with large threading holes. Steel crochet hook No. 7.

Make two balls first in this way:

HOW TO MAKE BUTTON BALLS

1. Make 4 chain stitches. Join first and last stitches in a ring with a slip stitch.

2. Make 2 single crochets in each chain stitch. There will be 8 stitches. Do not join them. Work round and round.

3. Make 2 single crochets in each stitch of first row (16 stitches).

4. Make 6 rows of 16 stitches each, or 96 single crochets, working round and round.

5. Stuff this form just made with soft cotton, filling it until it is firm but not hard. Then draw in the top of the ball by making single crochets in every other stitch until the opening is closed.

Cut off the thread about 5 inches from the ball, and draw it through the last stitch. Leave the end hanging.

To Make the Chain:

1. Thread the 6 beads on the cotton and push them back near the spool.

2. Commencing about 5 inches from the end of the cotton, make 2 loose chain stitches. Pull out the loop of the second chain stitch until it is nearly $\frac{1}{2}$ inch long.



To Make Bead Stitch:

3. Now throw the thread over the crochet needle; that is, "wrap," (holding the chain stitch between the thumb and second finger of the left hand) and put the hook into the first chain stitch under 2 threads. Throw the thread over the needle and pull

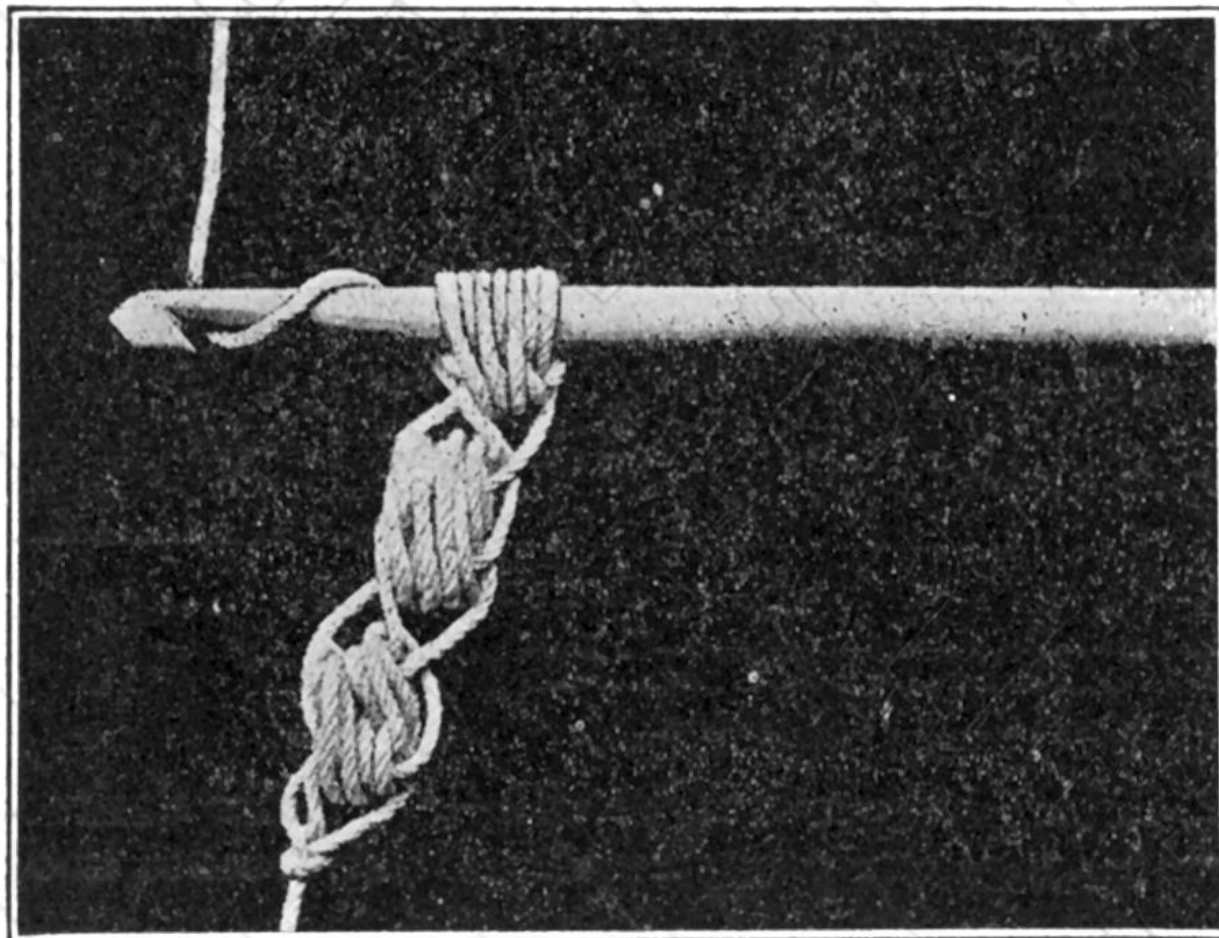

a long loop through the chain stitches, making it the length of the first drawn through.

Throw the thread over the crochet needle, or "wrap," and draw another loop up on the hook in the same way.

Continue to wrap and draw up loops in this way until there are 7 loose loops on the crochet needle. (See picture.) Wrap once again, and draw a loose loop through all 7 loops already on the needle.

Wrap and draw a loop through the stitch then on the needle. Draw this stitch through until it is the length of the loops in the first cluster.

Holding the first cluster between the thumb and second finger of the left hand, wrap, and put hook through the loop just below the loop on the needle (at the right), and *back* of the *single* thread at the left. (See picture above.)

Draw up a loop.

Wrap; draw up a loop and continue to draw up loops until there are 7 loops on the needle. Wrap, and draw a loose loop through the seven loops. Make 1 loose chain stitch.

Make another cluster of stitches to form another bead.

After the third cluster is made, make 3 chain stitches, and slip 1 bead down the thread until it meets the chain. Put the hook through the hole in the bead, and catch the last chain stitch. Pull the bead down over the chain stitches.

Draw up the last loop of the chain about $\frac{1}{2}$ inch, and make a cluster of stitches as in beginning the work.

Make 2 more clusters; add another bead.

Make 2 more clusters, and add one more bead.

Continue to make clusters until the chain is nearly as long as desired. Then add the beads as explained above and make 3 more clusters. Cut off thread about 5 inches from the end of the work, and make one chain stitch to fasten end, drawing it all the way through.

To Fasten Balls on Ends of the Chain:

Thread the end of cotton left on the chain into a long-eyed needle and sew with several stitches to the top of the ball, running the end well down into the ball to fasten it securely before cutting it off.

LADY'S CROCHETED PURSE

(See picture opposite page 104)

Material: Fine mercerized blue, or lavender, or pink, or ecru, or gray, crochet cotton. Steel crochet needle No. 9. One bone ring, about $1\frac{1}{8}$ inch across.

Directions:

1. Chain 8; that is, make 8 chain stitches. Join in ring with slip stitch.

2. First row: Chain 3. Put 2 double crochets in each stitch of chains.

Join with slip stitch.

3. Second row: Like the first row.

4. Third row: Chain 3. Make 1 double crochet in the first stitch of row below. Make 2 double crochets in the next; 1 double crochet in the next; 2 double crochets in the next; and so on to the end of row. Join.

5. Fourth row: Chain 3.

Make 1 double crochet in each of the first 2 stitches; 2 double crochets in the third stitch; and so on to the end of the row.

6. Fifth and sixth rows: Chain 3. Put 1 double crochet in each stitch with 1 chain between.

This makes one side.

7. Make another side like the one just finished.

8. Join sides with picot edging.

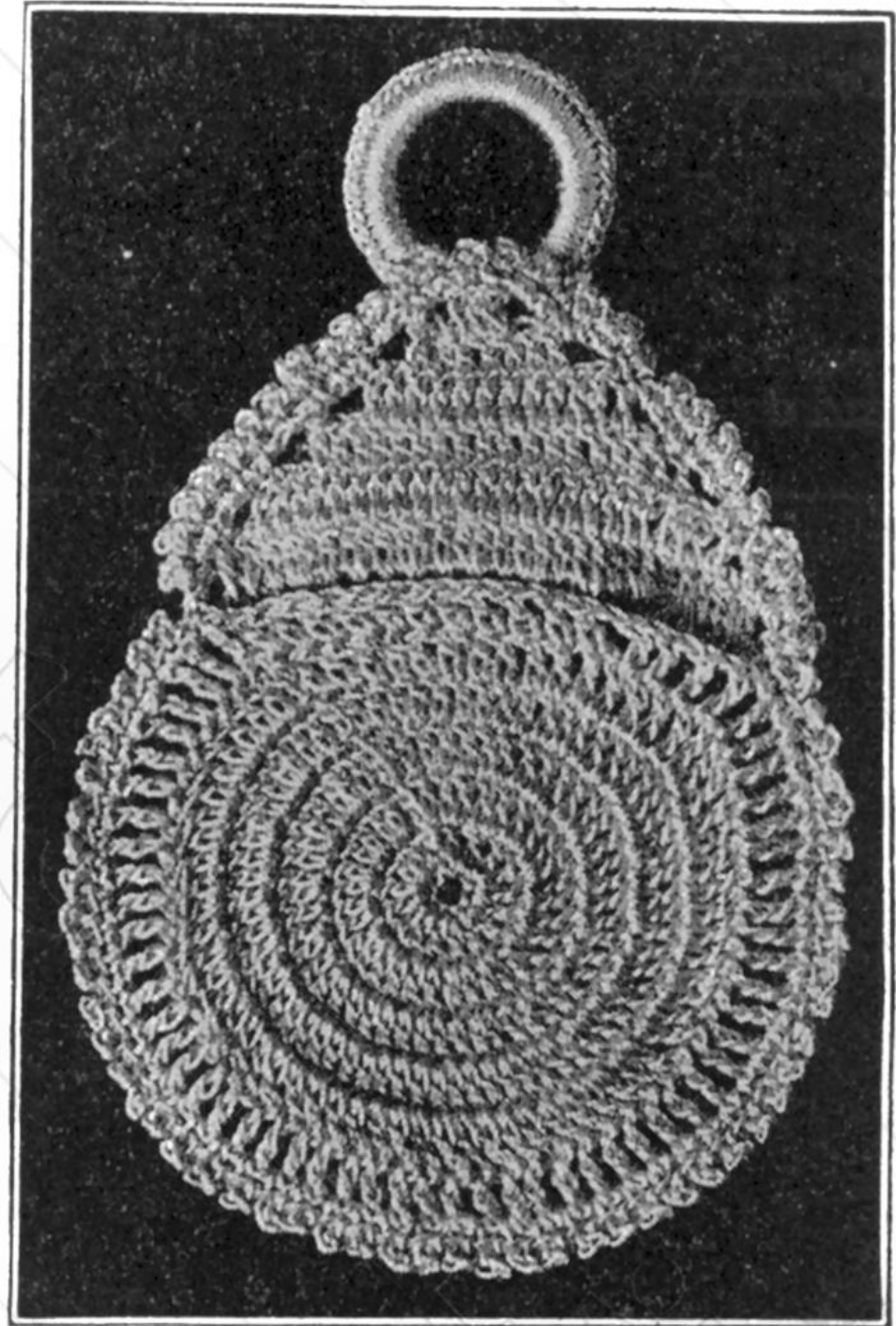

FRONT, SHOWING FLAPS

HOW TO MAKE PICOT EDGING

Use a piece of rather heavy cord to practice making picot (pēkō) edge.

1. Make a chain of 15 stitches.

2. Turn and make 14 single crochets. Make 1 chain stitch.

3. Turn, and putting hook under two threads, make 2 single crochets.

4. Make 3 chain stitches.

5. Now, pointing the hook toward the left thumb, put it through the top loop of the single crochet last made (where the chain was started), and then put it through the lower front loop of the single crochet last made. (See picture, page 256.)

6. Wrap and draw thread (a slip stitch) through all three loops and on needle. This forms a picot.

7. Make 2 single crochets, and make another picot. Continue in this way across the row. Now you are ready to join the sides of the purse together.

8. Hold both sides together with the joinings touching. Put the crochet hook

through the space between the first 2 stitches on each side. Make 1 single crochet. Chain 3 and fasten last chain stitch to single crochet just made with slip stitch as in Nos. 5 and 6. This makes a picot.

9. Continue to make picot edge, leaving 15 double crochets without the picot edge—to form an opening.

To Make the Flap:

(See picture on page 255)

1. Chain 3.
2. Put 2 double crochet in each space.
3. Chain 3 to turn. Skip 3 double crochets and put 1 double crochet in each of the 24 stitches. Skip 2 double crochets and put 1 double crochet in the end double crochet.

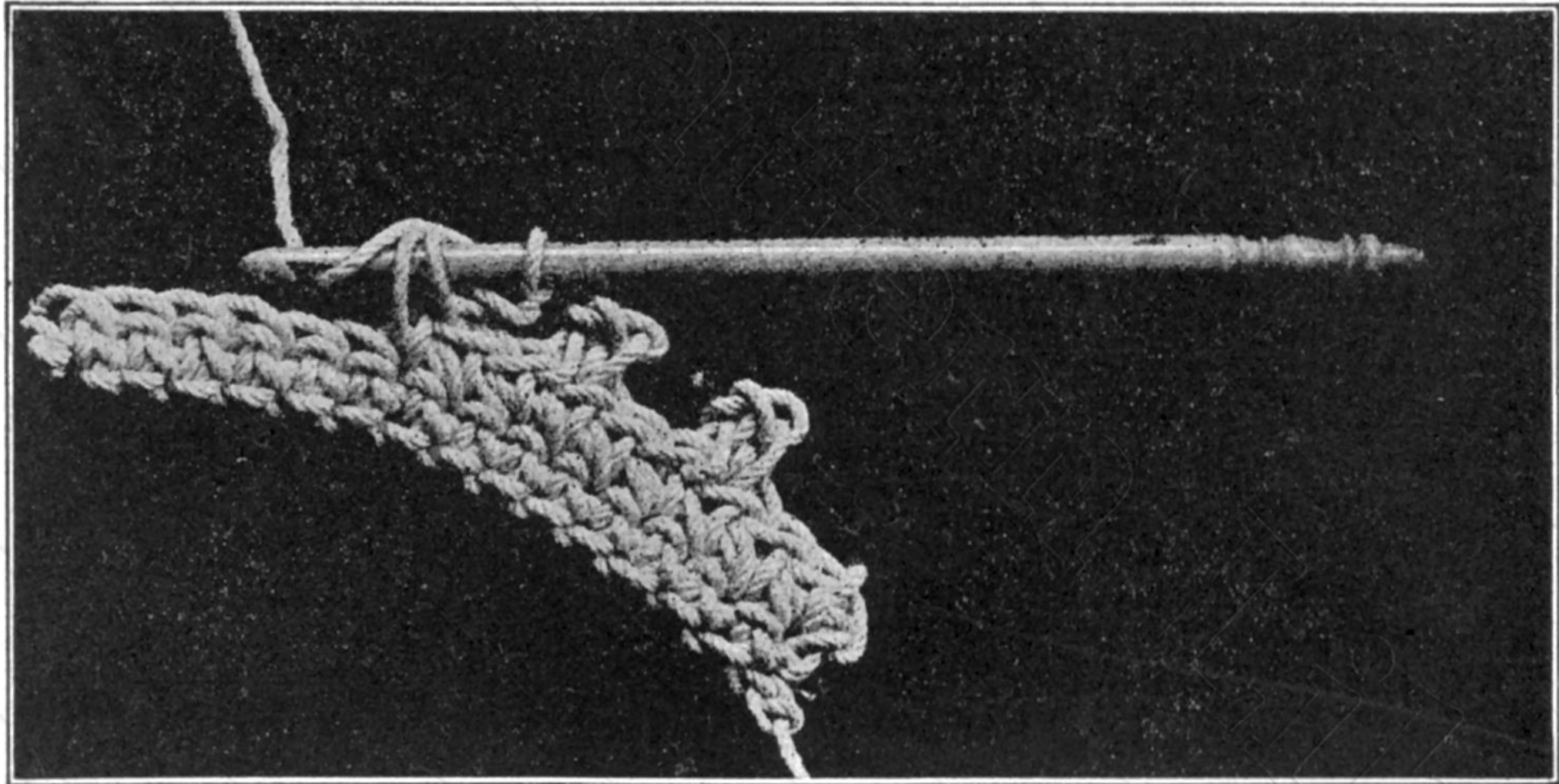

PICOT EDGING

4. Chain 3 to turn. Skip 3 double crochet, Make 1 double crochet in each of 18 double crochets in lower row. Skip 2 double crochets and put 1 double crochet in the end double crochet.
 5. Chain 3. Skip 3 double crochets. Make 12 double crochets. Skip 2 double crochets. Make 1 double crochet on end.
 6. Chain 3. Skip 3 double crochets. Make 7 double crochets. Skip 2 double crochets. Make 1 double crochet on end.
 7. Chain 3. Skip 2 double crochets. Make 3 double crochets. Skip 2 double crochets. Make 1 double crochet on end.
- Break off and fasten cotton.
8. Put picot edge around the flap in the same way as you did around the purse. Fasten thread.
- Fold flap over into place.

To Make the Strings:

1. Holding the back of the purse toward you, fasten the cotton into the fifth space from the joining point of the sides.

2. Chain 25. Catch the twenty-fifth chain stitch into the bone ring with a single crochet.

3. Chain 25. Skip 2 spaces on the top of the purse, and fasten the twenty-fifth chain into the third opening with a single crochet.

4. Make 9 strings of chain stitches, fastening them at the ends as explained.

5. Cover the ring with single crochet.

6. Make 25 chain stitches, and fasten last chain stitch in the place where the strings were started. Fasten thread.

7. Sew snap fasteners on purse and flap.

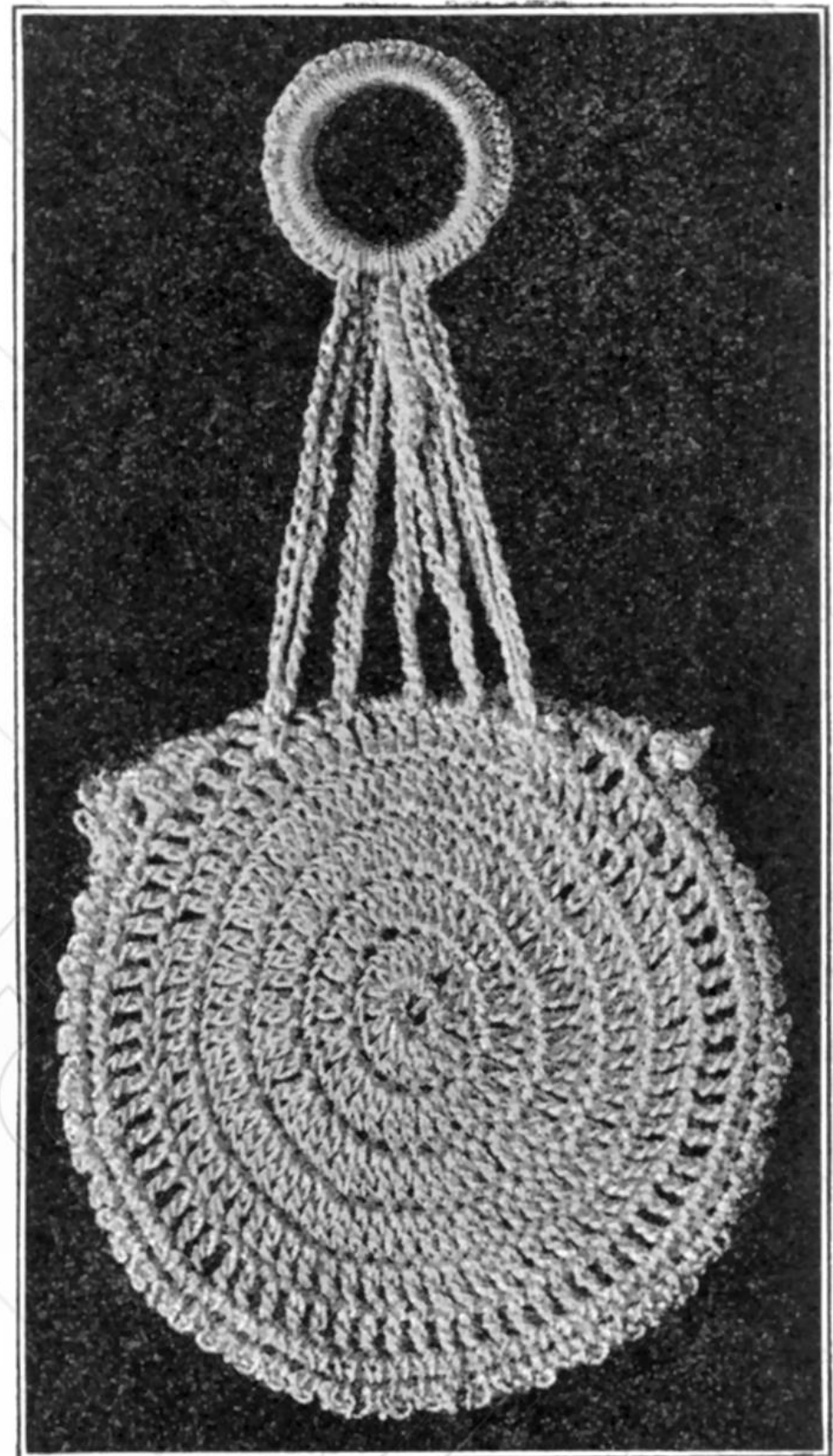

BACK OF PURSE

DOLL'S KNITTED MUFF

(See picture opposite page 200)

Material: White Angora wool, or Teazle yarn. If Teazle yarn is used, before sewing the garments up, brush with a clean stiff brush to make them furry. Bone knitting needles No. 2.

Directions:

1. Cast on 15 stitches,
2. Knit 20 ribs (a row across and back makes a rib).
3. Bind off.
4. Sew beginning row and last row of stitches together, and line muff with satin.
5. Make a long chain of the yarn to use to hang muff on doll's neck, Trim lower edge with fringe. Cut $3\frac{1}{2}$ -inch strands of yarn for making fringe. Draw 2 strands through at a time.

DOLL'S KNITTED BOA OR STOLE

(See picture opposite page 200)

Material and Needles: The same as for Doll's Muff.

Directions:

1. Cast on 8 stitches. Knit plain.
2. Increase 1 stitch on each rib at one end only until there are 14 stitches.
3. Make 42 ribs on the 14 stitches; then

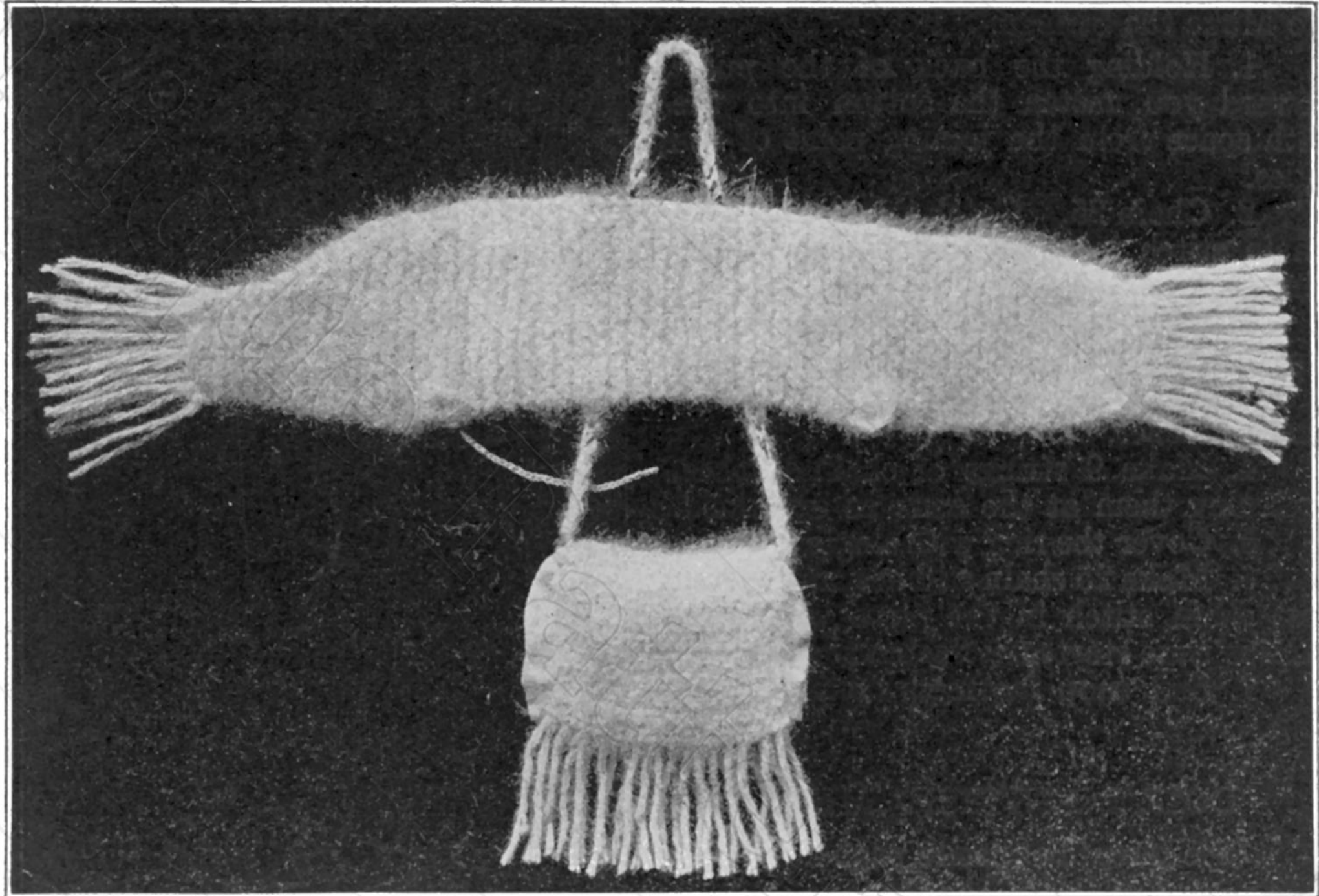

MUFF AND BOA

4. Narrow on one edge by knitting off 2 stitches together as one, on each rib until there are 8 stitches.
5. Bind off.
6. Trim with fringe same as fringe on muff.
7. Make a 2-inch chain of gold color mercerized cotton and sew it to each side of the neck of the stole.
8. Make 2 fancy rings like those made on doll's sleeveless sweater (see page 189), and sew one over each place where the gold chain was fastened.

TO MAKE THE TRIMMING BAND ON HAT

(See picture opposite page 200)

Crochet a chain a little longer than needed to meet around the band, Put 1 treble crochet into each chain stitch. (See page 228.)

In sewing trimming band on hat, let the treble crochet puff out, and bring the edges of the band close together.

The pompon is made in the same way as the pompons on the Doll's Crochet Toque or Cap.

DOLL'S KNITTED BREAKFAST SHAWL

(See picture on page 87)

Material: White wool floss and pink mercerized cotton. Bone knitting needles No. 5.

Directions:

1. With white floss cast on 30 stitches.
2. Knit plain for 50 ribs. (A rib is a row across and back.)
3. Bind off.
4. Lay 1 strand of floss side by side with 1 strand of pink cotton, and pick up each stitch along edge for collar.

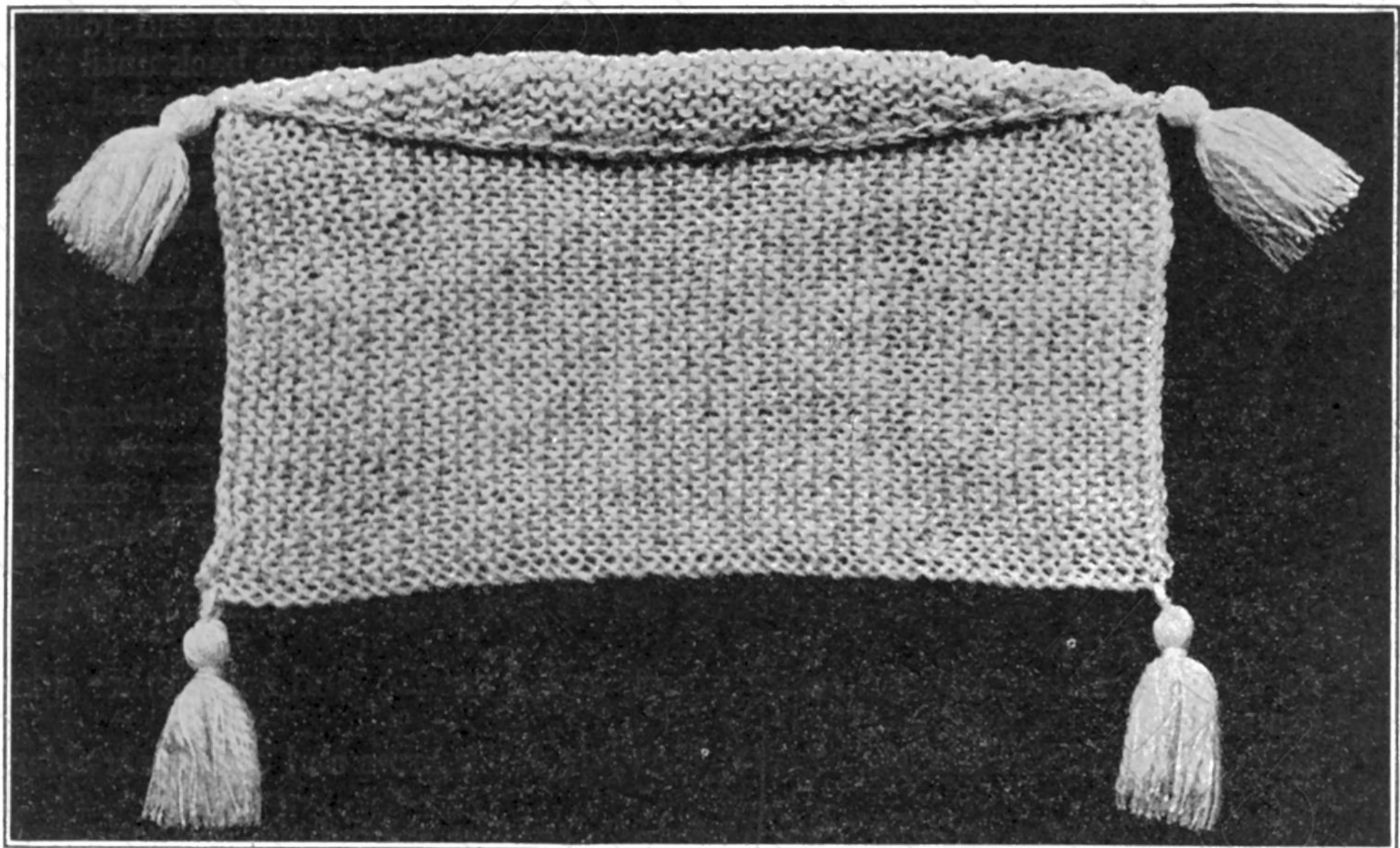

5. Knit plain, narrowing at each end (by knitting first 2, and last 2 stitches together as one) until there are 9 ribs.
6. Bind off.
7. Put 1 row of single crochet around edge of collar.
8. Make tassels of the white and pink.
9. Sew a tassel on each corner of the cape.

DOLL'S KNITTED SLEEVELESS SILK SWEATER

(See picture opposite page 230)

Material: Mercerized rose pink cotton No. 3, with turquoise blue cotton No. 3 for trimming; or crochet silk No. 3. Bone crochet hook No. 3. Bone knitting needles No. 3.

Directions:

To Make the Back:

1. With pink material cast on 36 stitches,
2. Knit 2, purl 2, for 20 rows, slipping off first stitch on each row.
3. Knit plain for 11 ribs. (A row across and back makes a rib.)
4. Knit 2 stitches off as one at each end, every other row, until there are only 28 stitches on the needle.
 5. Knit plain until you have 20 ribs.
 6. Bind off.



DOLL'S SILK SWEATER

To Make the Front:

1. Cast on 36 stitches and follow directions for making the back until the 11 ribs of plain knitting are finished.
2. On the twelfth rib, narrow at each end by knitting first 2 and last 2 stitches together, making 34 stitches on the needle.
3. Slip 17 stitches on to a safety pin, keeping the remaining stitches on the needle.
4. Narrow by knitting 2 stitches together at each end every other row until there are 11 stitches; then narrow only on the neck edge, every other row until there are 8 stitches.

5. Knit ribs of 8 stitches until there are 23 ribs from the waist line to the shoulder, and bind off.

6. Take the stitches off the safety pin on to the needle; and make other side like the first.

Sew fronts and back of the sweater together under arms and on the shoulder lines.

With the blue cotton, put 2 rows of single crochet around the armholes and neck taking up each stitch.

HOW TO CAST ON STITCHES WITH KNITTING NEEDLES

1. Make a slip knot on one knitting needle near the end of the yarn.

2. Knit 1 stitch. (See page 162, To Knit a Stitch.) Do not take the stitch off the left-hand needle, but stretch the new stitch (which is on the right-hand needle) and slip it over the point of the left-hand needle. (See picture on page 261.) Hold the stitch on the left needle with the thumb of the left hand.

Continue to make new stitches and slip them on the left needle until there are the number of stitches required.*

* Other methods are explained on pages 150 and 155.

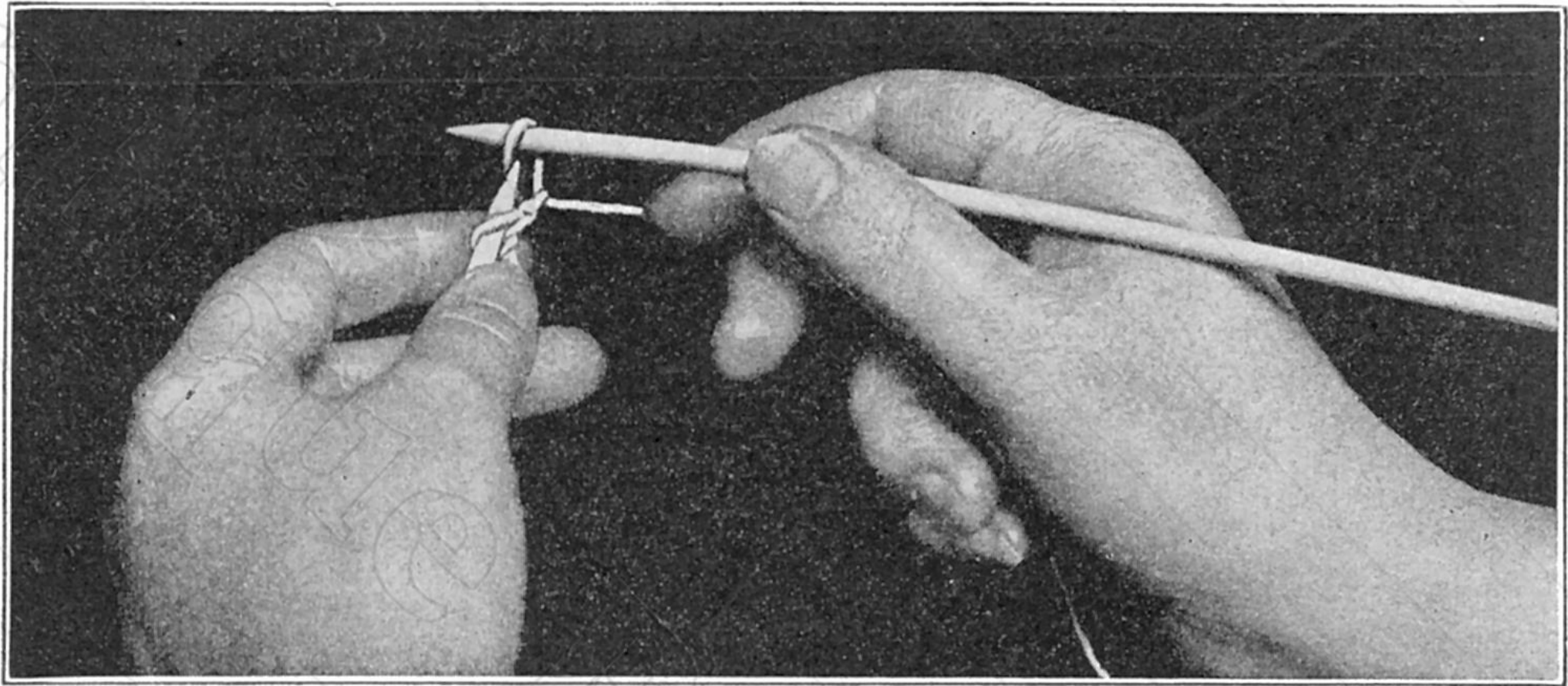

TO CAST ON STITCHES WITH KNITTING NEEDLES (See page 260)

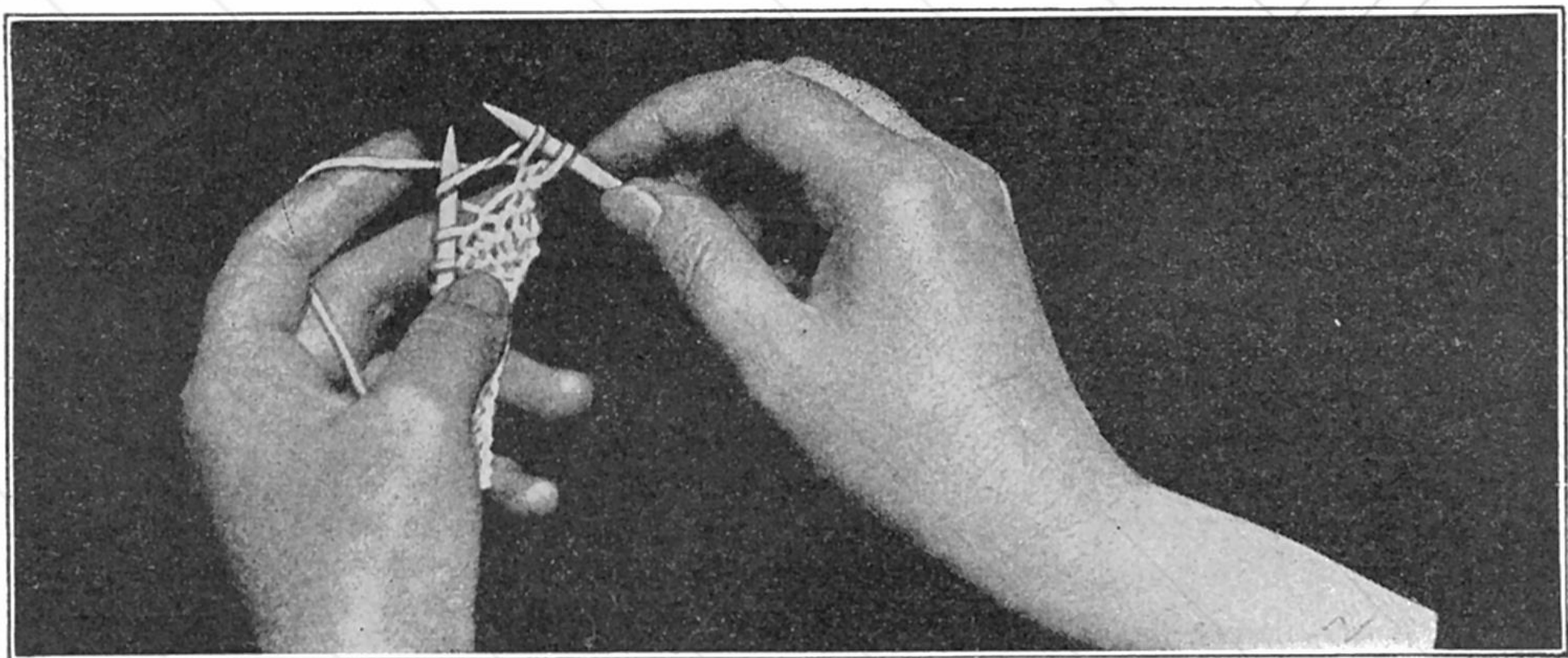
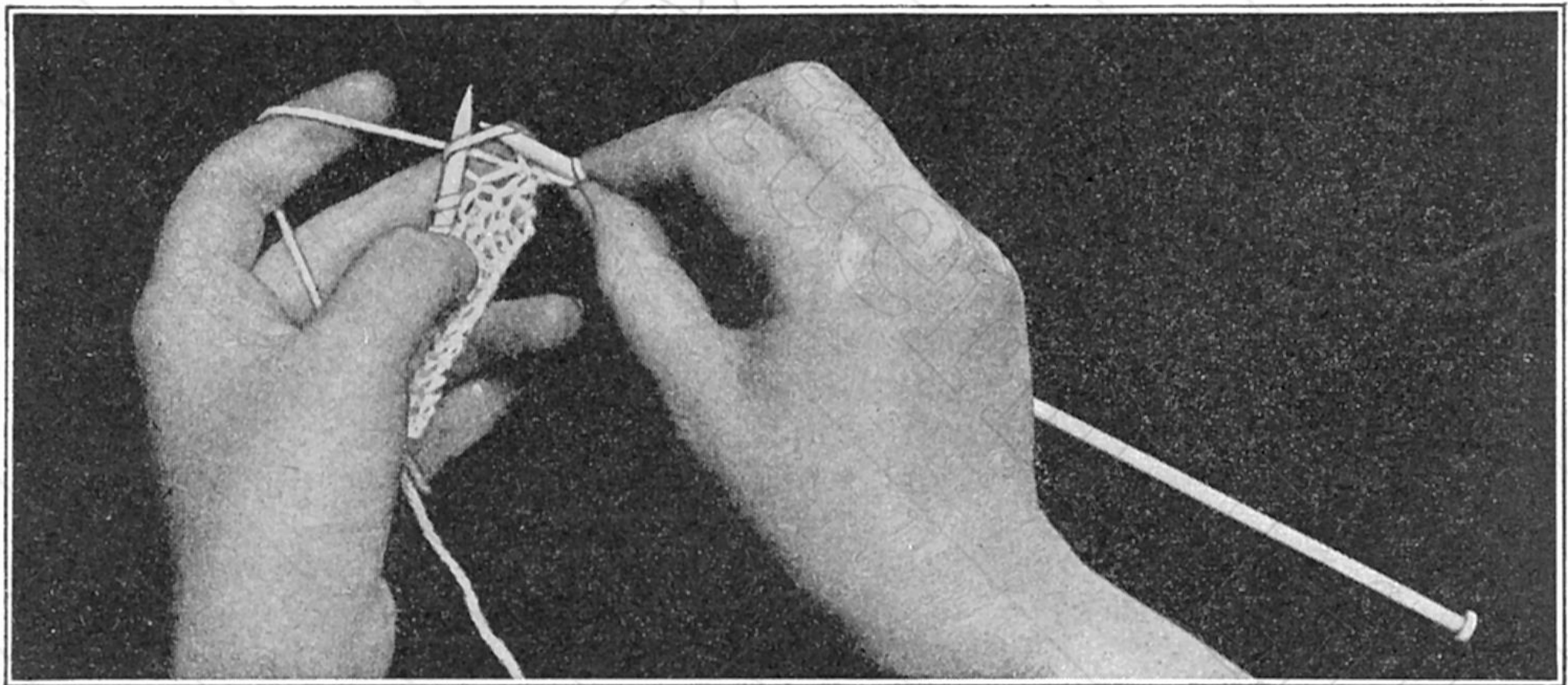

2 and 3. THE CONTINENTAL METHOD OF KNITTING (See page 262)

THE CONTINENTAL METHOD OF KNITTING

This method is a little more rapid than the Colonial or English method, but is not so much used. Notice the position of the hands in the picture.

To knit plain the straight thread on the second finger of the left hand is lifted with the point of the right needle. Cut 2.

A loop is drawn through; and the top loop on the left needle is drawn off the point of the left needle. Cut 3. Finish this row.

To purl, hold hand in same position as above. Slip the first stitch off the left needle. Put the point of the right needle under the thread which is fast to the ball, and lift it toward you over the left needle, holding the thread on the right needle with the right thumb.

Keeping the thread on top of the right needle put the point through the top of the first loop on the left needle, pointing the right needle toward the middle of the palm of the left hand.

Lift the point of the right needle toward you and over the thread. Push the point of the right needle backward through the loop on the left needle (which the right needle is already through) carrying the thread through the loop.

Slip the top loop off the point of the left needle.

TO CAST OFF STITCHES

(Another method of binding off work)

1. Slip the first stitch. 2. Pointing the left needle toward the first finger of the right hand, insert it in the slipped stitch *under* the right needle. The two needles will now be crossed in the loop. 3. With the thumb and first finger of the left hand push this loop over and back of the next stitch on the left needle, and knit the next stitch, bringing the two loops off the left needle. Repeat to end.

In using the Continental Method, the thread is thrown as in purling.

CHAPTER XXXVIII TWO MORE SWEATERS

CHILD'S KNITTED SWEATER*

Size 6 to 8 years

7 balls colored Shetland floss, 1 ball white. 1 pair knitting needles No. 7.

Body. With colored floss cast on 72 stitches (16 inches), knit 6 ribs (12 rows), drop floss temporarily; with white knit 1 rib and fasten off; pick up colored floss and knit 5 ribs; join white and knit 1 rib, fasten off; with colored floss knit 50 ribs. Work should now measure about 16 inches from beginning. Cast on 50 stitches at each side for sleeves and knit 22 ribs. On next row knit 77 stitches and slip on to a spare needle, bind off 18 stitches for neck, knit remaining 77 stitches and knit back. Increase one stitch at neck every other rib 12 times, bind off the 50 sleeve stitches and on the remaining 39 stitches knit 15 ribs even, ending the last row at front opening; slip these stitches on to the spare needle and knit the other front to correspond, ending the last row at underarm. Knit stitches from both fronts (78) on to one needle and knit even for 35 rows, then work border as on back; bind off loosely on wrong side.

* Courtesy Bear Brand Yarn Manufacturers.

TWO MORE SWEATERS

263

Cuff. Working with colored floss from wrong side pick up 35 stitches around wrist and knit 4 ribs, with white knit 1 rib, with colored floss knit 5 ribs, with white 1 rib, with colored floss 2 ribs; bind off loosely on wrong side. Sew up sleeves and underarm seams, turn back cuff.

Collar. With colored floss cast on 56 stitches and knit 2 ribs, with white knit 1 rib, with colored floss knit 5 ribs, with white knit 1 rib, with colored floss knit 22 ribs. Next row knit 18 stitches and slip on to a spare needle, bind off 20 stitches for neck; on remaining 18 stitches knit left side of collar, increase one stitch at neck every other rib 11 times, working border as in back after 13th rib from neck; bind off on wrong side and knit other side of collar to correspond.

Sash. With colored floss cast on 15 stitches and knit 6 ribs, with white knit 1 rib, with colored floss knit 5 ribs, with white knit 1 rib, with colored floss knit 34 inches and then work border as at other end. Cut white floss in strands 4 inches long; knot 2 strands in each stitch and tie all together one inch from end of sash, to form a tassel. Attach sash to underarm seams with pearl buttons. Lace front with a ribbon tie.

LADY'S KNITTED SWEATER†

27 balls colored Germantown, 1 ball white. 1 pair knitting needles No. 5.

This sweater is knitted crosswise in plain stitch. (Garter stitch.) The stars mean to repeat the directions between them.

Back. Cast on 120 stitches (24 inches), *knit 5 ribs even; in 6th rib decrease 1 stitch at each side; repeat from *4 times, then decrease every 10th rib each side 6 times; knit 10 ribs even, or until piece measures 20 inches at side. Bind off 6 stitches at each side for armholes, then decrease one stitch every other rib 6 times—12 stitches, in all, decreased for each armhole. The 74 stitches now left on needle should not measure more than 15 inches; knit 18 ribs even. *In next row leave 5 stitches at end of needle, turn and knit to within 5 stitches at other end, turn, thus working back and forth, each time leaving 5 stitches more than before at end of needle on both sides until only 34 stitches are worked over, then knit 2 ribs over the entire 74 stitches on needle and bind off.

Front. Cast on 80 stitches and knit 10 ribs even; keep front edge straight and decrease at other side one stitch every 6th rib 6 times, then decrease at same side every 10th rib 6 times. Work even until front is as long as back at underarm seam (68 stitches on row, which should measure 13½ inches). Bind off 10 stitches at sloped side for armhole, then decrease at same side one stitch every rib in each of the following 10 ribs. From now on keep edge straight at armhole and decrease one stitch at neck in each of the following 20 ribs. *In next rib bind off 6 stitches at armhole for shoulder and decrease one stitch at neck as before; repeat from*

† Courtesy Bear Brand Yarn Manufacturers.



Courtesy of "Bear Brand Yarn Manufacturers"

3 times and fasten off. Mark out on the finished front the places for buttons (on 2d, 20th and 38th rib from neck) and on second front make buttonholes in corresponding places, as follows: beginning from front edge knit 5 stitches, bind off 4 stitches, knit to end of row; on next row cast on 4 stitches opposite those bound off. Sew up shoulder seam over 24 stitches.



Courtesy of "Bear Brand Yarn Manufacturers"

Sleeves. Cast on firmly 18 stitches and knit 1 row, then cast on 3 stitches at beginning of each needle until there are 78 stitches in row (30 stitches added at each side). Knit 8 ribs even, then decrease one stitch at each side every 5th rib 14 times. There will then be 50 stitches on row, which should measure 10 inches across. Knit even until sleeve measures 16 inches at underarm seam. Now increase one stitch in center of row every 3d rib 3 times; knit 2 ribs even and bind off on wrong side. Sew up underarm seams and place buttons as shown in illustration.

Pockets. Cast on 30 stitches and knit even for 20 ribs; in following row knit 10 stitches, bind off 10 stitches, knit to end of row; next row cast on 10 stitches opposite those bound off; knit 4 ribs even and then bind off the 10 center stitches for second opening; next row cast on 10 stitches at center as before; knit 12 ribs even. Decrease by knitting 2d and 3d stitches together in beginning of every row (thus narrowing at both sides) until there are 10 stitches left; knit 8 ribs even, then decrease again at each side until only 1 stitch is left; fasten off. Using white yarn and a crochet hook, make a slip stitch in each stitch on edge of strap, as shown in illustration. Slip the tab through the strap opening and fasten point down with a button.

Collar. With colored Germantown cast on 66 stitches and knit 2 ribs; in next row knit 6 stitches, turn and knit back to edge (outer edge of collar), turn, knit 12 stitches, turn and work back to edge; continue in this way, each time knitting 6 more stitches off needle at one side and at other side always knitting back to edge, until all the 66 stitches are again worked in a row. Knit straight for 65 ribs, or until collar measures 13 inches at inner edge; knit to within 6 stitches of end of row at inner edge, turn and knit back to outer edge, turn, knit to within 12 stitches of inner edge, turn and work back to outer edge; continue in this way until only 6 stitches are knitted from outer edge, work back and then knit 2 ribs on the entire 66 stitches. Join white, knit 10 ribs even and bind off on wrong side. Pick up the 66 stitches cast on at beginning of collar and make second border like first, having both borders bound off on same side.

Belt. With colored Germantown cast on 22 stitches and knit straight for 31 inches; on next rib make 2 buttonholes of 4 stitches each, 3 stitches from each end; knit 4 ribs even and bind off on wrong side.

CHAPTER XXXIX

RED CROSS KNITTING*



EQUIPMENT

This circular is prepared primarily for the use of hand knitters. Knitting machines may be used if desired, provided the articles can be as well made and made of the same yarn.

The color of the yarn has been carefully considered with the authorities of the War Department and with the American Red Cross Commissioner for Europe, in Paris. It has been learned from both of these sources that articles made in either gray or khaki yarn will be acceptable. Owing to the difficulty of securing khaki-colored yarn in large quantities the American Red Cross Supply Bureau will carry the gray yarn (Oxford mixture, 4-ply 10's construction).

Yarn and knitting needles may be procured either from Red Cross Chapters or from stores, provided the yarn is of the same grade and needles of the same size as those described in this circular.

The needles referred to in these directions are standardized Red Cross needles which can be purchased from Red Cross Chapters. Their diameter is given opposite their respective number.

Red Cross Needles No. 1.		125/1000 inches.
Red Cross Needles No. 2.		175/1000 inches.
Red Cross Needles No. 3.		200/1000 inches.

GENERAL DIRECTIONS

Stitches should not be cast on too tightly.

Knitting should be done evenly and firmly and all holes should be avoided.

Joining should be done by splicing or by leaving two or three inches at each end of the yarn to be darned in carefully.

All knots, ridges or lumps should be most carefully avoided, especially in socks, as they are apt to blister the feet.

MUFFLER

Material: 2 hanks of yarn ($\frac{1}{2}$ lb.); 1 pair Red Cross needles No. 3.

Cast on 50 stitches or 11 inches. Plain knitting for 68 inches.

*For the convenience of knitters the directions from the circular of Red Cross instructions are here given.

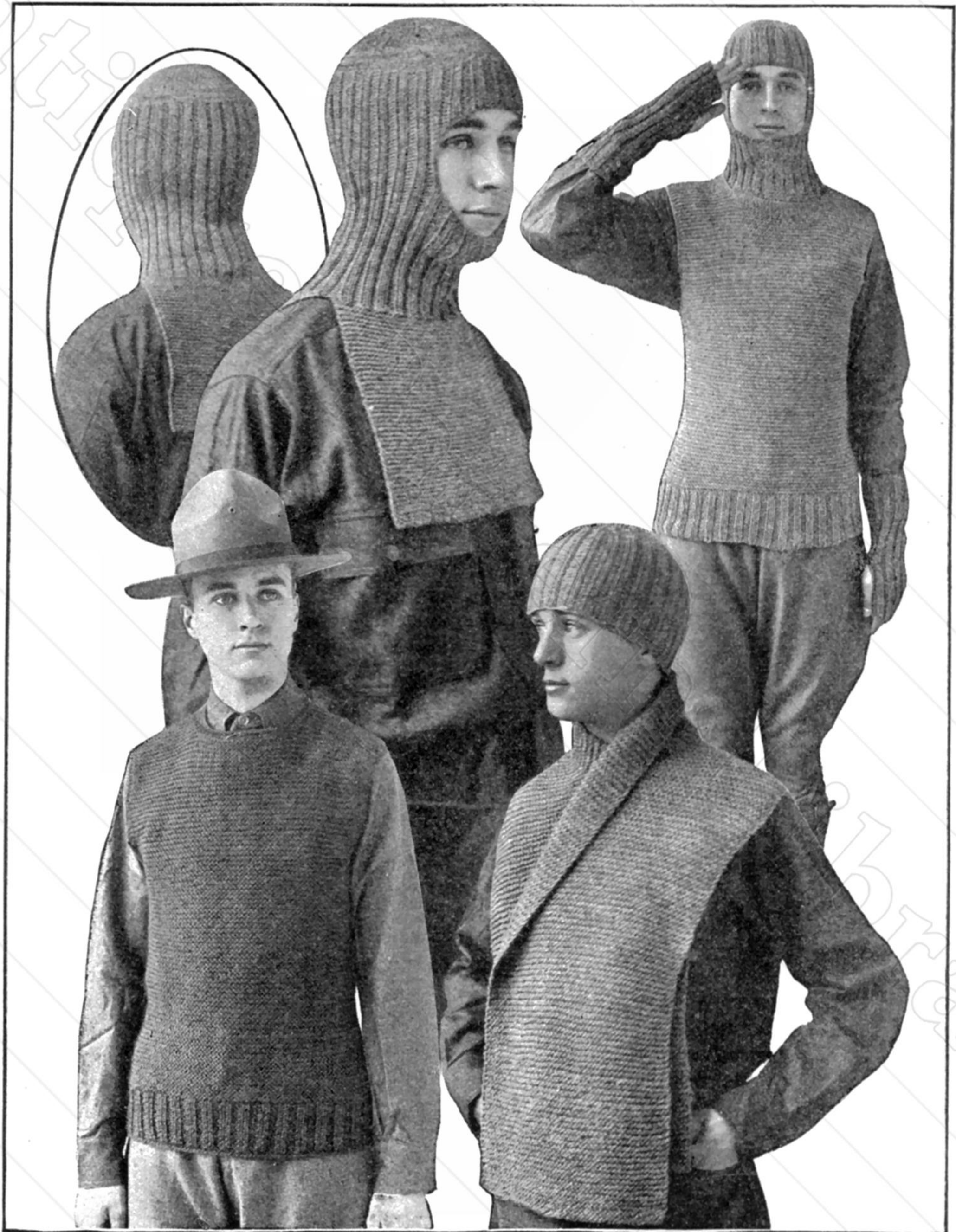

Courtesy Bear Brand Yarn Manufacturers.

RED CROSS KNITTING

RED CROSS KNITTING

267

WASH-CLOTH

Material: White knitting cotton (medium weight); 1 pair Red Cross needles No. 1.

Directions:

Cast on 70 stitches, knit back and forth plain until cloth is about 10 inches square and bind off. Sew a loop of tape to one corner.

SLEEVELESS SWEATER

Material: 2½ hanks of yarn ($\frac{5}{8}$ lb.); 1 pair Red Cross needles No. 3.

Directions:

Cast on 80 stitches. Knit 2, purl 2 stitches for 4 inches. Knit plain until sweater measures 25 inches. Knit 28 stitches, bind off 24 stitches for neck, loose. Knit 28 stitches. Knit 5 ridges on each shoulder, cast on 24 stitches. Knit plain for 21 inches. Purl 2, knit 2 stitches for 4 inches. Sew up sides, leaving 9 inches for armholes. Two rows single crochet around neck and 1 row single crochet around the armholes.

KNITTED HELMET No. 1

Material: 1 hank of yarn ($\frac{1}{4}$ lb.); 1 pair Red Cross needles No. 2.

Directions:

The Helmet is made in 2 parts, which afterwards are sewed together along the top and sides.

Front of Helmet.—Cast on 48 stitches (11 inches), knit plain for 25 ribs (6 inches) and knit 2, purl 2 for 35 rows. On the next row the opening for the face is made as follows: Knit 2, purl 2, knit 2, purl 2, knit 2, knit and bind off loosely the next 28 stitches and purl 1, knit 2, purl 2, knit 2, purl 2. Run the stitches before the opening on a spare needle and on the stitches at other side of opening knit 2, purl 2 for 12 rows. The last row will end at the opening and at that point cast on 28 stitches to offset those bound off. Begin at the face opening of stitches on spare needle and knit 2, purl 2 for 12 rows. At the end of the twelfth row continue all across to the end of other needle, when there should be 48 stitches on needle as at first. Knit 2, purl 2 for 24 rows.

Top of Helmet.—Knit 2, narrow (knitting 2 stitches together), knit 14, narrow, knit 14, narrow, knit 12. Purl the entire next row. On the third row knit 2, narrow, knit 13, narrow, knit 13, narrow, knit 11. Purl fourth row. On the fifth row knit 2, narrow, knit 12, narrow, knit 12, narrow, knit 10. Purl sixth row. Continue to narrow in the 3 places every plain knitted row with 1 stitch less between narrowings until 9 stitches are left.

Back of Helmet.—Work in same manner as for front but omit the face opening. Sew the stitches of upper edges together with joining stitch. Sew up the side seams leaving the plain knitting at shoulders open.

KNITTED HELMET No. 2

(Same as No. 1, but knitted in one piece)

Material: 1 hank of yarn ($\frac{1}{4}$ lb.); 4 Red Cross needles No. 2.

Directions:

Cast on 56 stitches loosely. Knit plain for 8 inches for front piece, and leave on extra needle. Knit another piece to correspond for back. These pieces must be at least 9 inches wide. Slip the stitches of both pieces on to 3 needles, arranging for last 2 stitches of back piece to be on beginning of first needle, with 38 stitches of front piece added (making 40 on first needle).

Divide rest of stitches on other 2 needles; 36-36.

Beginning with first needle, knit 2, purl 2 for 6 inches. Then on first needle knit 2, purl 2 for 18 stitches. Bind off 22 stitches for face opening. (Try to keep same arrangement of stitches on needles for further directions.) Knit 2, purl 2 forward and back on remaining 90 stitches for $1\frac{1}{2}$ inches, always slipping first stitch. Cast on 22 stitches loosely to complete face opening, and knit 2, purl 2 for $2\frac{1}{2}$ inches (adjust stitches by slipping 2 from end of third needle to first needle, making 42 on first needle).

Knit 1 round plain. Knit 2 stitches together, knit 11, knit 2 stitches together, knit 1. Repeat to end of round. Knit 4 rows plain. Then knit 2 stitches together, knit 9, knit 2 together, knit 1. Repeat to end of round. Knit 4 rows plain. Continue in this way, narrowing on every fifth round and reducing number of stitches between narrowed stitches by 2 (as 7, 5, 3, etc.) until you have 28 stitches left on needles. Divide on 2 needles, having 14 on first needle and 14 on the other, and finish the same as for the toe of a sock.

WRISTLETS No. 1

Material: $\frac{1}{2}$ hank of yarn ($\frac{1}{8}$ lb.); 1 pair Red Cross needles No. 2.

Directions:

Cast on 48 stitches, knit 2 and purl 2 for 12 inches, and sew up leaving 2 inches open space for thumb 2 inches from the edge.

WRISTLETS No. 2

Material: $\frac{1}{2}$ hank of yarn ($\frac{1}{8}$ lb.); 4 Red Cross needles No. 1.

Directions:

Cast on 52 stitches on 3 needles: 16-16-20. Knit 2, purl 2 for 8 inches. To make opening for thumb, knit 2, purl 2 to end of third needle, turn; knit and purl back to end of first needle, always slipping first stitch; turn. Continue knitting back and forth for 2 inches. From this point continue as at first for 4 inches for the hand. Bind off loosely and buttonhole thumb opening.

MEDIUM SIZED SOCK

Quantity of wool required: about one-quarter pound.

56 stitches on three No. 1 Red Cross needles (20 on first needle, 20 on second needle, 16 on third needle).

Heel:

Knit 2, purl 2, for 3 inches.

Knit plain 8 inches.

Divide stitches: 28 on first needle (for heel), 14 on second needle, 14 on third needle.

First needle (*): Knit 1 row, turn. Purl 1 row, turn. Repeat from (*) until you have 27 rows. Always slip first stitch.

To Turn Heel:

Begin to turn heel on wrong side.

Slip 1, purl 15, purl 2 together, purl 1, turn.

Slip 1, knit 5, slip 1, knit 1, pass slipped stitch over knit stitch, knit 1, turn.

Slip 1, purl 6, purl 2 together, purl 1, turn.

Slip 1, knit 7, slip 1, knit 1, pass slipped stitch over knit stitch, knit 1, turn.

Slip 1, purl 8, purl 2 together, purl 1, turn.

Slip 1, knit 9, slip 1, knit 1, pass slipped stitch over knit stitch, knit 1, turn.

Continue until there are 16 stitches on needle.

Gusset:

Pick up 13 stitches on side of heel. (1st needle.) Knit stitches of 2d and 3d needles onto one needle. (2d needle.) Pick up 13 stitches on other side of heel, and take 8 stitches from first needle. (3d needle.) *1st needle*—(A) Knit to within 3 stitches of end, knit 2 together, knit 1. *2d needle*—(B) Knit plain. *3d needle*—(C) Knit 1, slip 1, knit 1, pass slipped stitch over knit stitch, knit to end. (D) Knit around plain.

Repeat A, B, C, D, until you have 14 stitches on 1st needle, 28 stitches on 2d needle, 14 stitches on 3d needle. Knit plain 5½ inches.

Kitchener Toe: *1st needle*—(E) Knit to within 3 stitches of end, knit 2 together, knit 1. *2d needle*—(F) Knit 1, slip 1, knit 1, pass slipped stitch over knit stitch, knit to within 3 stitches of end, knit 2 together, knit 1. *3d needle*—(G) Knit 1, slip 1, knit 1, pass slipped stitch over knit stitch, knit to end. (H) Knit 2 rows plain.

Repeat E, F, G, H, 3 times (making 4 times in all). Then narrow every other row 5 times.

Knit the 5 stitches of your 1st needle onto your 3d needle. You have now 10 stitches on each of the two needles. Break wool (leaving 12-inch length) and thread it into worsted needle. Hold sock so that the worsted needle is at your right and, always keeping wool under knitting needles, weave front and back together as follows: (*) Pass worsted needle through 1st stitch of front knitting needle as if knitting and slip stitch off the knitting needle.



Pass through 2d stitch as if purling and leave stitch on the knitting needle. Pass through 1st stitch of back needle as if purling and slip stitch off the knitting needle. Pass through 2d stitch of back needle as if knitting and leave stitch on knitting needle.

Repeat from (*) until all stitches are off needles. In order to avoid ridges across end of toe, fasten wool down the side.

Laid on a level surface the finished sock should measure: Foot—Length, $11\frac{1}{2}$ inches, but $10\frac{1}{2}$ to $12\frac{1}{2}$ is acceptable. Leg—Length, 14 inches; circumference, 8 inches. Cuff—Circumference, unstretched, 6 inches; stretched to fullest extent, $13\frac{1}{2}$ inches.

BED-SOCK

Material: 4 Red Cross needles No. 2, 1 hank yarn ($\frac{1}{4}$ lb.).

Directions:

Cast on 48 stitches on 3 needles, 16 on each.

Knit plain and loosely for 20 inches. Decrease every other stitch by knitting 2 together with 12 stitches and weave together as per directions on sock.

HOT WATER BOTTLE-COVER

Material: White knitting cotton (medium weight); 1 pair Red Cross needles No. 1.

Directions:

Cast on 56 stitches, knit 2, purl 2 and repeat until the work is 4 inches deep. Then knit back and forth plain for $9\frac{1}{2}$ inches more or until entire work measures $13\frac{1}{2}$ inches. Next decrease 2 stitches at beginning and 2 stitches at end of each needle until there are sixteen stitches left and bind off. Make another piece in same manner and sew together. Attach a 20-inch piece of tape to seam at one side of ribbing to tie around neck of bottle.

Antique Pattern Library