

WELDON'S

GUIDE TO FOLDING

85 ILLUSTRATIONS.



3^D
COMPLETE

Serviettes.

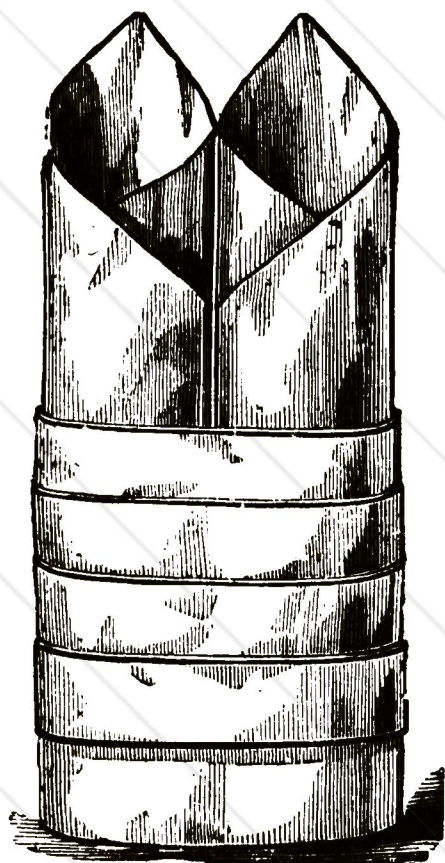

Banded Scroll Design.



Lily Leaf Design.

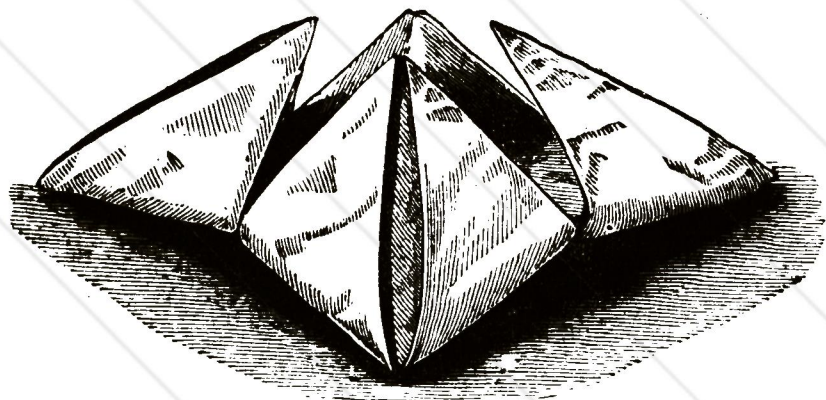

Pocket Design.

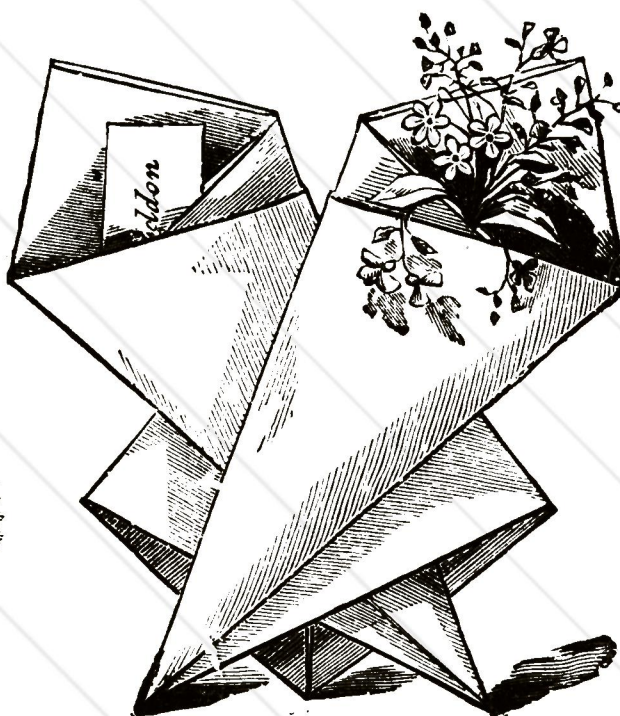

Double Pocket Design.

CONTENTS.

Banded Scroll Design.
 " " Diagrams.
 Clarendon Design.
 " " Diagrams.
 Cardinal's Hat Design.
 " " Diagrams.
 Double Pocket Design.
 " " Diagrams.
 Fan Design.
 " " Diagrams.
 Hood Design.
 " " Diagrams.
 Lily Leaf Design.
 " " Diagrams.
 Mitre Design.
 " " Diagrams.
 Pocket Design.
 " " Diagrams.
 Scroll Design.
 " " Diagrams.
 Screen Design.
 " " Diagrams.



CAUTION.—The Illustrations & Letterpress in this Magazine are Copyright; the Publishers reserve all rights of Reproduction. Regu. at Stationers' Hall.
 WELDON'S, Ltd., Fashion Publishers, 30 & 31, Southampton St., Strand, London, W.C., and all Newsagents and Bookstalls.

For Further Examples of Serviette Folding see the **Second Series of Weldon's Guide to Folding Serviettes,**

Price 2d.,

Containing the following Designs—

Candle Shade, Double Basket, Double Fan, Double Pyramid, Fan Pyramid, Letter W
 Lily Leaf, Mushroom, Palm Leaf, Prince of Wales, Table Fan, Tent, and Tulip.

WELDON'S GUIDE TO FOLDING SERVIETTES.

EIGHTY-FIVE ILLUSTRATIONS.

DESCRIPTION OF ILLUSTRATIONS.

NOTHING adds so much to the adornment of a dinner or supper table as nicely folded finger napkins or serviettes, therefore doubtless many ladies will be desirous of being initiated in this art, for indeed it is an art, when one comes to consider the multiplicity of pretty and ingenious designs that can be formed out of a piece of well-stiffened linen.

This series will commence with a practical and attractive arrangement called

THE CLARENDON DESIGN.

This is a simple, yet thoroughly effective design, and, as will be seen by the diagrams, is easily folded, therefore it forms a good pattern for daily use, or a quickly arranged one, when time is of importance. It requires a square, well-stiffened napkin, which should be folded in three equal parts to represent diagram 1, the dotted lines in which denote the position for the next two folds.

Diagram 2 shows the second and third folds accomplished, and which are simply done by folding either end of diagram 1 to the centre. The slanting lines on diagram 2 are intended to show the position for the next two folds.

The fourth and fifth folds are done by turning the two upper corners of the napkin over to appear like diagram 3, and beneath these folds will be seen two slanting dotted lines as a guide for folds 6 and 7.

To accomplish these turn the napkin over from right to left so as to bring what was the under part to the top. Now fold up the two lower corners to appear like diagram 4, which shows the 6th and 7th folds completed. Now take up the napkin by each end, which hold between the thumb and

finger of each hand, then bend the napkin from you through the centre lengthways, well pressing the fold, when it will be found to resemble No. 5 in shape and stand perfectly steady upon the table, lending somewhat the effect of a tent, the hollow of which should face you, and which will be found a nice receptacle for the bread. A

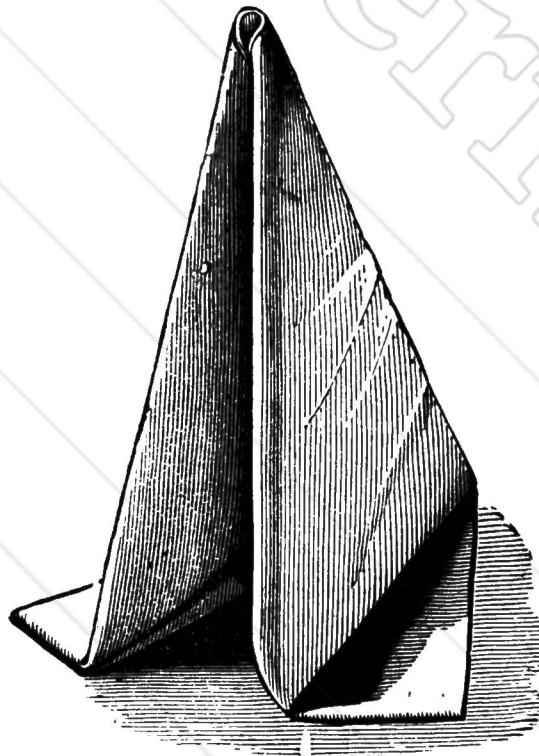

The Clarendon Design.

complete set of paper patterns showing each fold of the Clarendon Design can be had for 6½d., post free.

THE FAN DESIGN.

It is only necessary to allow about two inches or so of the fan when folded to rest inside the glass, just enough, in fact, to balance it nicely, and although it may look a little complicated at first sight, it is really an easy and wonderfully effective design for dotting here and there on the table, or for

standing on a sideboard, etc. The first thing to do is to take a square napkin, and make a crease directly through the centre from right to left, as this will form a guide for folds 1 and 2. No. 1 diagram shows the way to fold the top right-hand corner down to the centre, then fold the top left-hand corner down to correspond, which will bring the napkin to the shape as illustrated by No. 1, the dotted lines immediately below the figures 1 and 2 merely forming a guide for the folder when doing folds 3 and 4. No. 2 diagram denotes these, which are simply arranged by turning the left and right corners back, as very clearly illustrated, giving folds 3 and 4. No. 3 diagram shows how the lower edge of the napkin has to be turned right up, taking the upper part of the triangle on either side of No. 2 diagram as a guide for getting this fold level, the dotted line just above this fold denoting the wrong side of the fold you first made to ascertain the centre of the napkin, and thus the fifth fold is completed. No. 4 diagram shows how to fold the napkin back at the dotted line or centre fold, making the sixth fold. No. 5 diagram represents the lower part of the napkin turned up again to bring its edge on a level with the edge of the third and fourth folds, which makes the seventh fold complete. No. 6 diagram shows the napkin turned back again, when it will appear exactly as diagram, thus completing the eighth and last fold for this design. It now remains to commence from one end to pleat up this folded napkin, just as fan pleats are done, making them small and as even as possible, after which pull down each side, when it will represent a fan for standing in a tumbler, as shown by illustration 7. A complete set of paper patterns, showing every fold of the Fan, can be had for 7d., post free.

The Screen Design.



This screen is simplicity itself to fold, and lends a great attraction to the table when dotted here and there.

Place serviette on table with the hem top and bottom before you, fold down top hem level with lower hem like diagram 1.

The next fold is accomplished by turning up one thickness of the serviette to bring the hem of same level with fold at top, as diagram 2, after which, turn serviette over from right to left, to bring the under-part uppermost, and fold up this side to correspond with diagram 3. Thus there are two folds directly before you, and the two hems divided by a fold at top.

Pleat serviette, which will press with the hand. Take the serviette in the left hand (the fold with single edge either side in the hand), hold firmly, or even tie here, then open out each pleat at the top and press down the *inner* point with the end of a pencil, or even the finger tip, as diagram 4.

Having done all the pleats along top thus, turn the serviette over from left to right, and proceed to pull the other side of top of each pleat down to correspond.

Holding the base of the pleats firmly together, pull the serviette out like the screen design, when it will stand on the table, leaning against the roll of bread, which should be placed at the back.

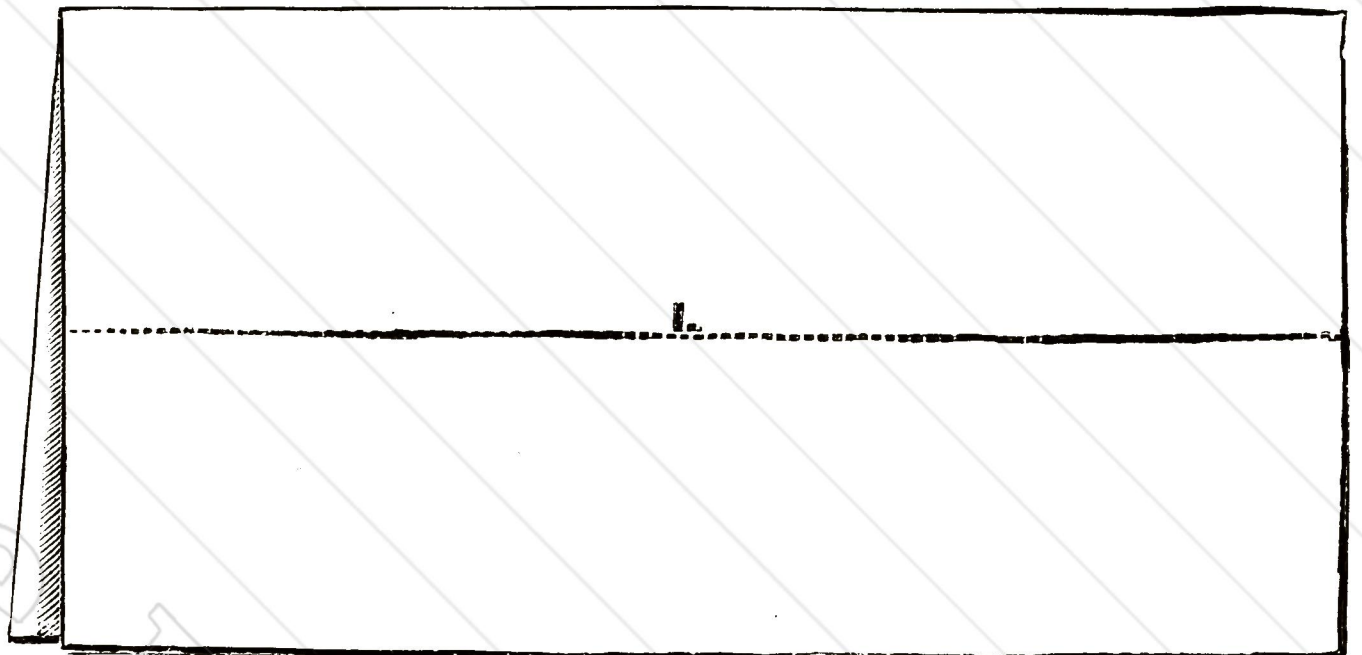

Diagram 1.—THE SERVIETTE FOLDED THROUGH THE CENTRE.

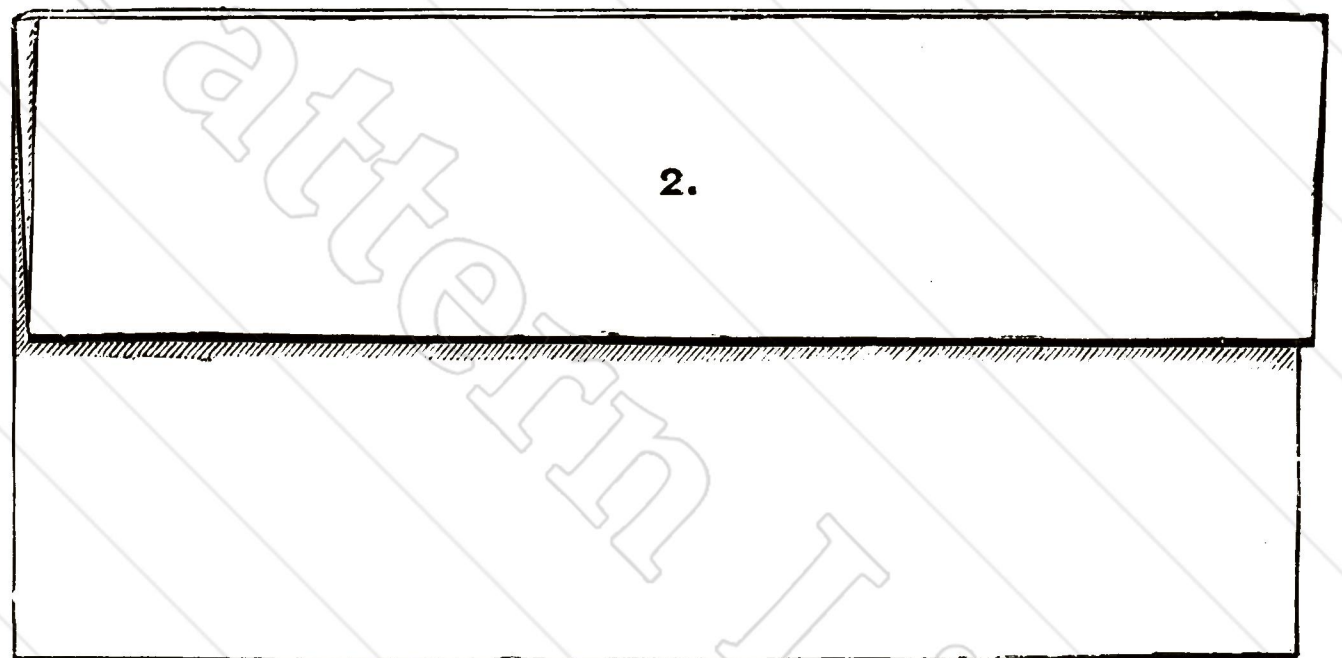

Diagram 2.—THE ONE OR TOP THICKNESS FOLDED UPWARDS.

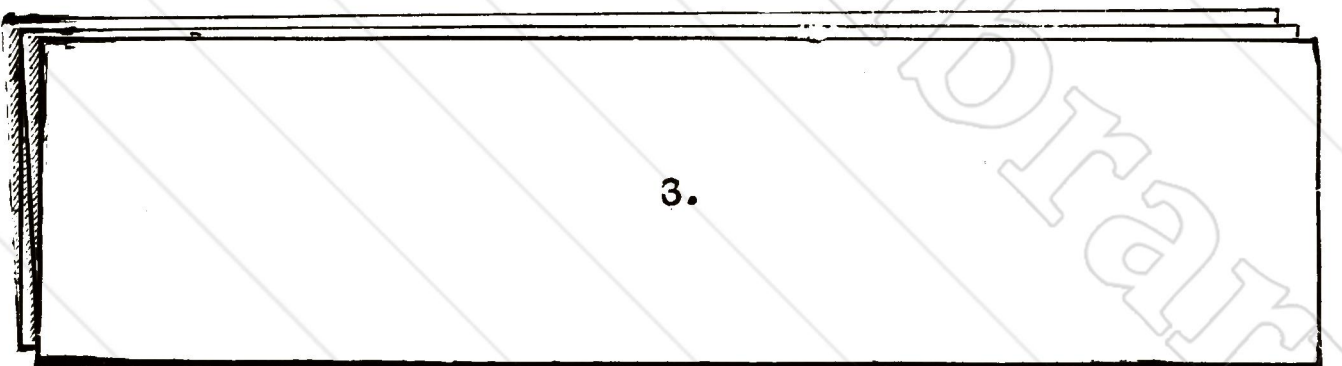

Diagram 3.—THE UNDER-PART OF SERVIETTE FOLDED UPWARDS.

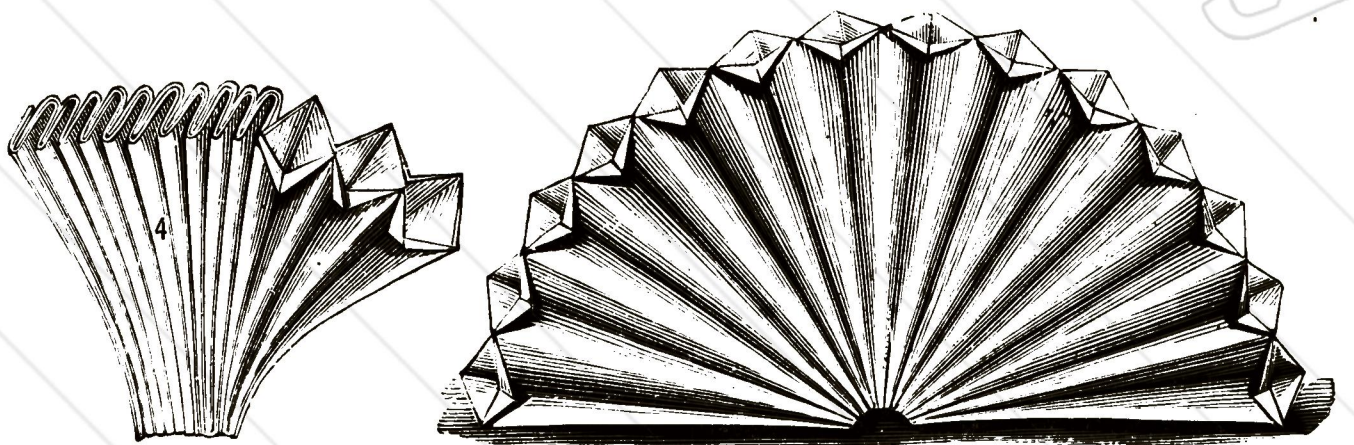

Diagram 4.—SHOWING THE PLEATING, ETC.

THE SCREEN DESIGN.

Weldon's Guide to Folding Serviettes.

THE SCROLL DESIGN.

This design is well worthy of attention, as it is quickly arranged, and forms a handy receptacle for the bread between the hollow of its two points. A well-starched square finger napkin is necessary, which should be folded in three (as shown by diagram 1), after which makes a crease down the centre as a guide for folds 2 and 3. Diagrams 2 and 3 clearly show how each end of the

dotted line immediately above figure 2, bringing the upper edge in a straight line down the centre, when your napkin will assume the shape as shown by diagram 4 and 5. Diagram 6 shows the 6th fold, which is accomplished by taking hold of the napkin between the thumb and first finger of the left hand at the centre of the 5th fold, this being indicated just above the figure 5 by a star. Hold it in a similar

extreme left-hand point and folding it over (as denoted by the dotted line in No. 6) towards the right, placing it under the triangle piece, on which the 6 is printed, in diagram 6. Now turn the napkin over from right to left, and take the extreme left-hand point and fold it towards the right, just as No. 7 fold was done, tucking the point under the triangle part, when it will appear as diagram 8, and which completes the folds,

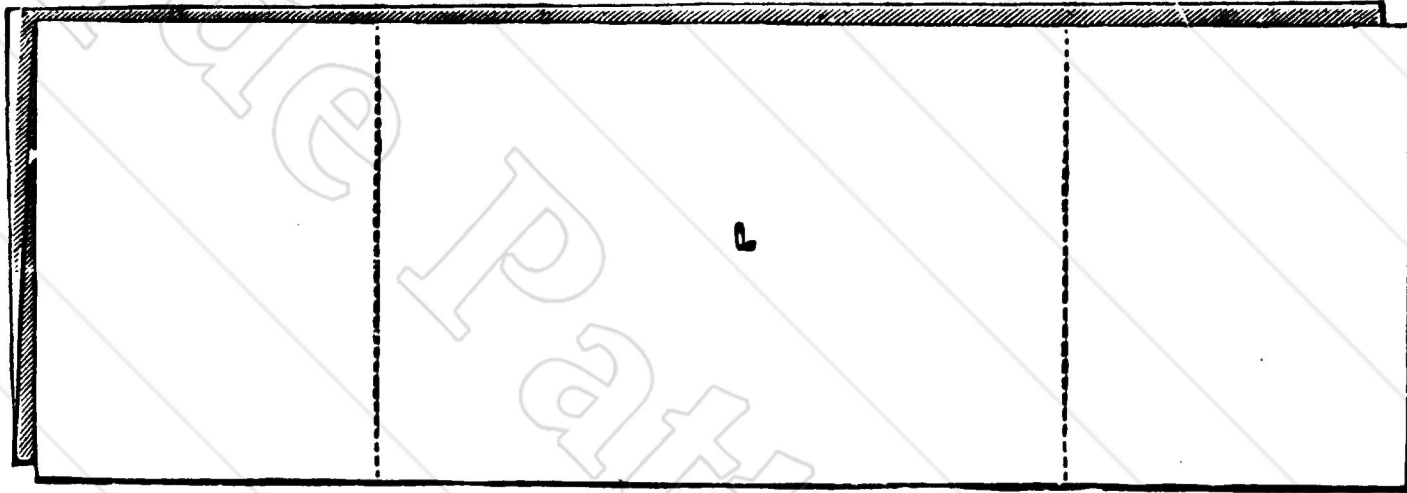

Diagram 1.—SHOWING THE 1ST FOLD.

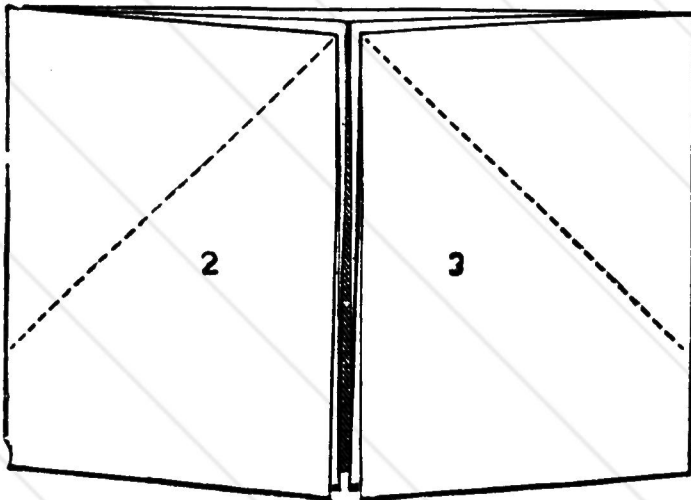

Diagram 2.—SHOWING THE 2ND AND 3RD FOLDS.

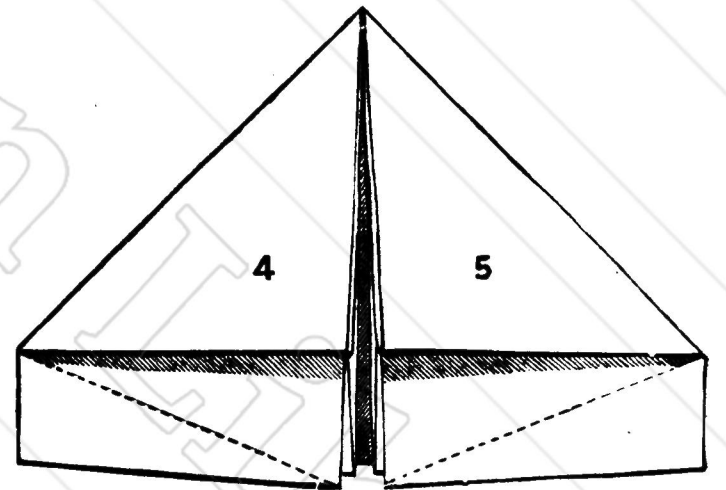

Diagram 3.—SHOWING THE 4TH AND 5TH FOLDS

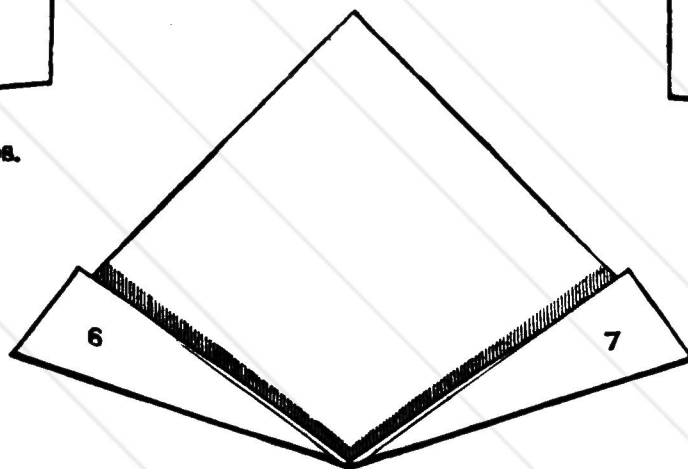

Diagram 4.—SHOWING THE 6TH AND 7TH FOLDS.

Diagrams for the Clarendon Design.

napkin is folded to the crease just made in the centre, thus forming folds 2 and 3, the dotted lines on this diagram forming a guide for folds 4 and 5. These folds, 4 and 5, are simply made by turning up the lower right-hand corner of the napkin (as denoted by the dotted line just below figure 3 in diagram 2 and 3), which brings the lower edge in a line directly down the centre, while the top left-hand corner has to be folded down, as clearly shown in the same diagram by a

manner between the thumb and finger of right hand at centre of 4th fold, as indicated ** just below the figure 4. Holding the napkin thus, lift it up and bring the edges together backward, when the thumbs and fingers will meet, and when, on laying it down, with the straight edge towards you, it will appear as seen in diagram 6, the dotted line in which gives the position for the 7th fold. Diagram 7 shows the 7th fold done, which is arranged by taking the

when it is merely necessary to insert the fingers up the hollow of the napkin and press it into shape, as clearly defined by illustration 9.

LILY LEAF DESIGN.

This design is quickly executed, while it is remarkably effective; the right-hand end, which on reference to illustration 5 will be found to resemble an arch, being placed

Weldon's Guide to Folding Serviettes.

4

directly in front of the guest, as the hollow of this arch forms a place or receptacle for the bread.

A square and moderately stiff finger napkin is necessary, which should be folded in half from right to left, then turned up

the napkin placed on the table just ready for the second fold.

This is arranged by folding the napkin through the centre so as to bring the lower four points up to touch the upper point, when it will form a triangle shape, as clearly

peat with the left-hand corner, when the napkin will appear exactly like diagram 3, and which also shows by the dotted lines on the lower part how to arrange the next fold.

This is accomplished by turning the ends

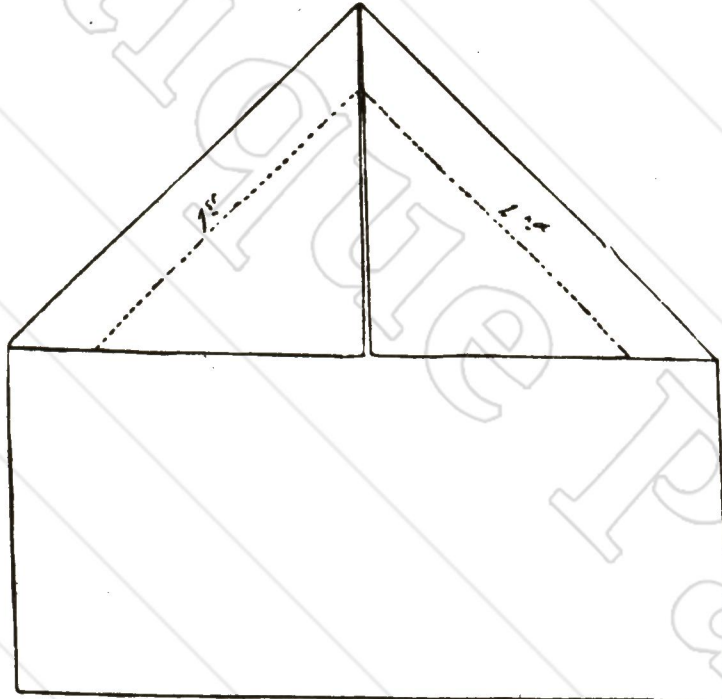

Diagram 1.—1ST AND 2ND FOLDS FOR FAN.

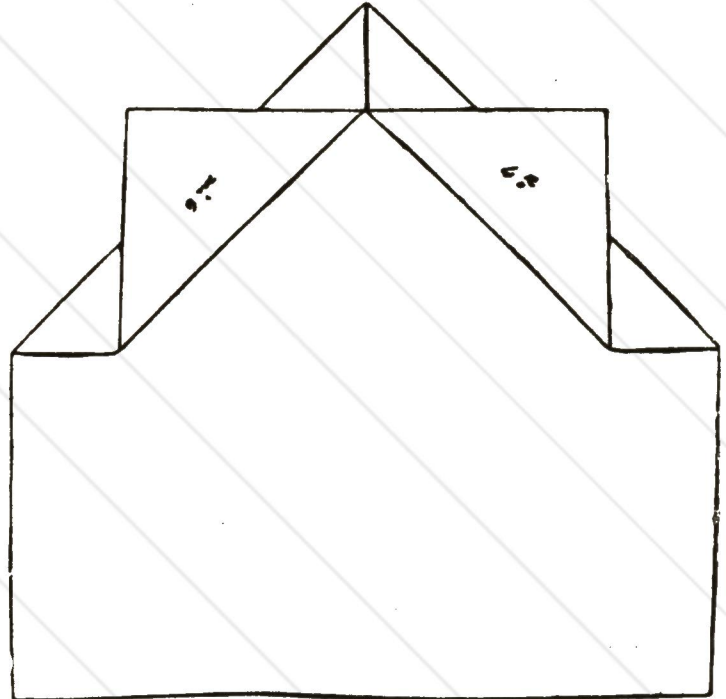

Diagram 2.—3RD AND 4TH FOLDS FOR FAN.

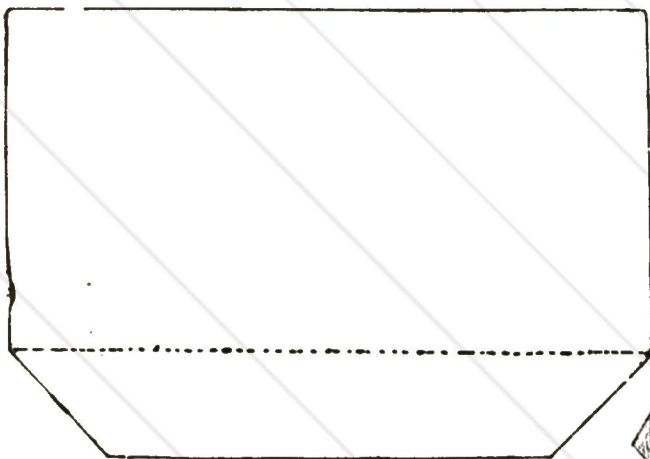

Diagram 3.—5TH FOLD FOR FAN.

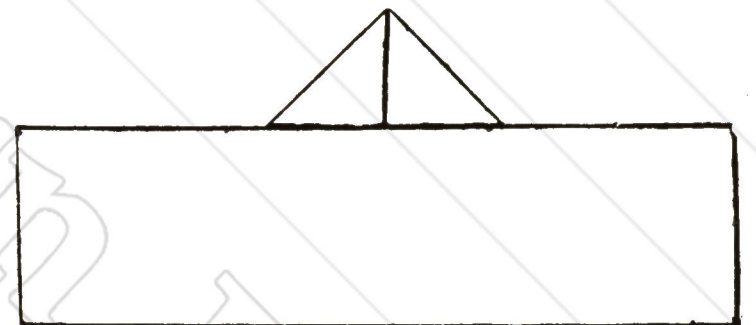

Diagram 5.—7TH FOLD FOR FAN.

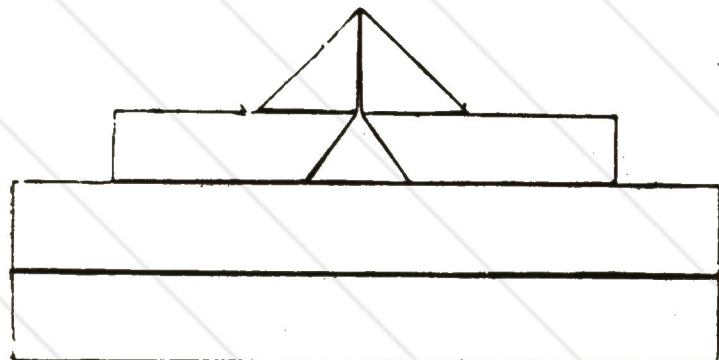
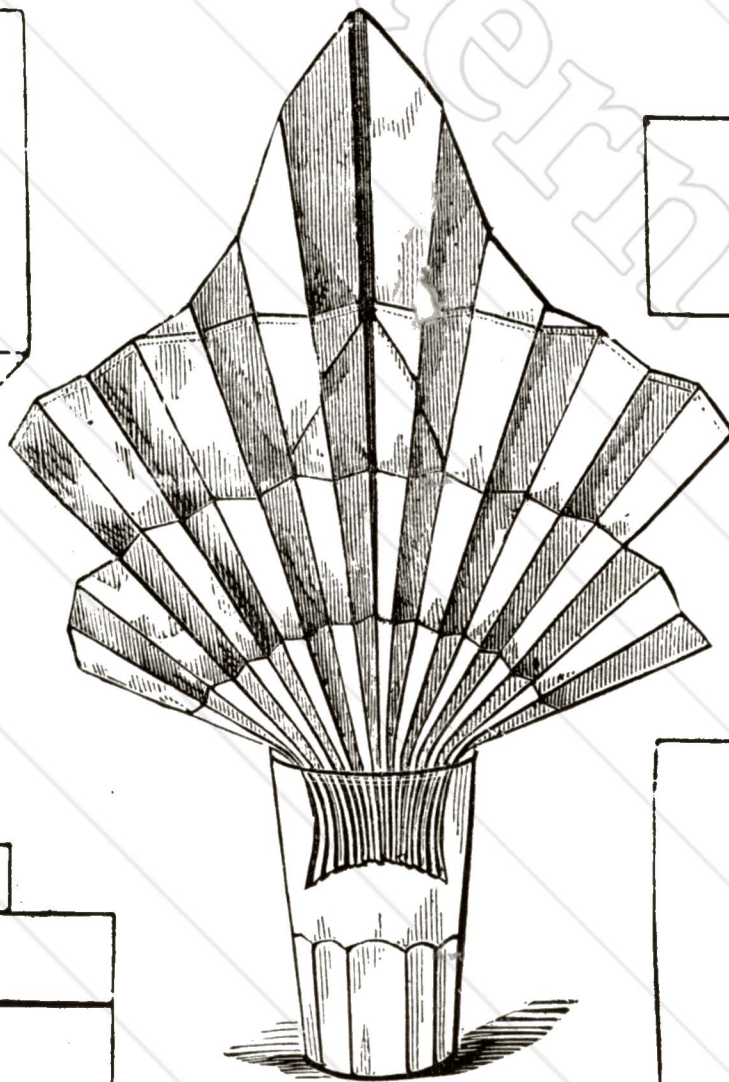

Diagram 6.—8TH FOLD FOR FAN.



No. 7.—FAN DESIGN.

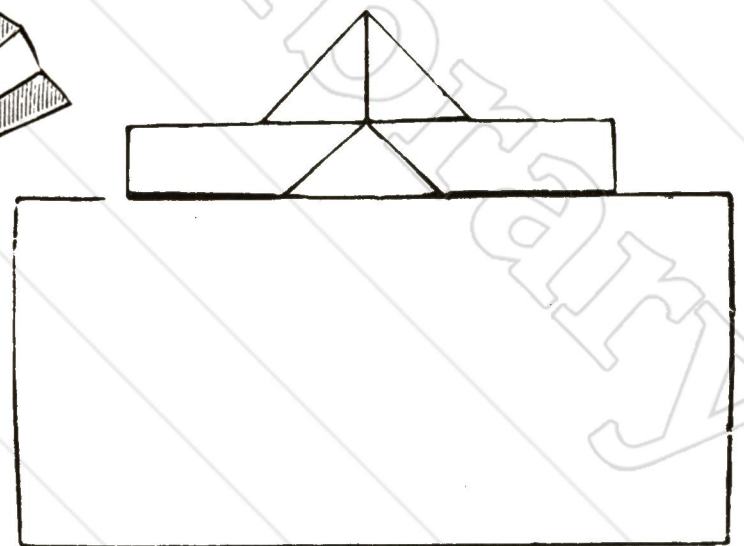

Diagram 4.—6TH FOLD FOR FAN.

THE FAN DESIGN.

from the lower edge to the top, thus bringing it to a smaller square of four thicknesses, which place upon the table before you in diamond shape, bringing the four points directly before you, as clearly shown on reference to diagram 1, and which represents

denoted by diagram 2, in which the dotted lines on either side give the position for the next folds.

Diagram 3 shows the third and fourth folds arranged by turning the right-hand corner over towards the centre. Then re-

of diagram 3 under, as clearly denoted by the dotted lines; then pick up the finger napkin and arch it in the middle by pressing the part where the corners have just been turned under, as if shaping it like the toe of a shoe, when it will, if nicely pressed, assum-

Weldon's Guide to Folding Serviettes.

the shape so clearly denoted by diagram 4, and which shows the fifth and last fold, leaving it ready for forming the leaves. At the extreme left hand of diagram 4 it will be found pointed; take up one of the thicknesses of the napkin at this point and pull it back nearly the length of the curved slope, and it will stand up as the first leaf, that is to say, the one nearest the arched part or

right-hand side of this diagram. Now take the next single thickness of the napkin and pull that up in the same way to form leaf 2, and repeat with the other two single thicknesses, when there will be four distinct nicely-curved leaves, while the lower part, or quadruple fold of the napkin, will remain for the stand or base, as clearly shown by illustration 5.

THE POCKET DESIGN.

This is a pretty and useful shape, as it holds the bread so nicely in the centre, and also affords a convenient design for taking pull bread, a glass dish of pickles, horse-radish, etc., which can be placed in the centre, around which the four corners stand out prettily.



Diagram 1.—SHOWING THE 1ST FOLD.

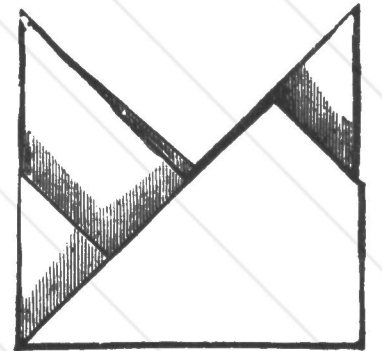

Diagram 8.—SHOWING THE 8TH FOLD.

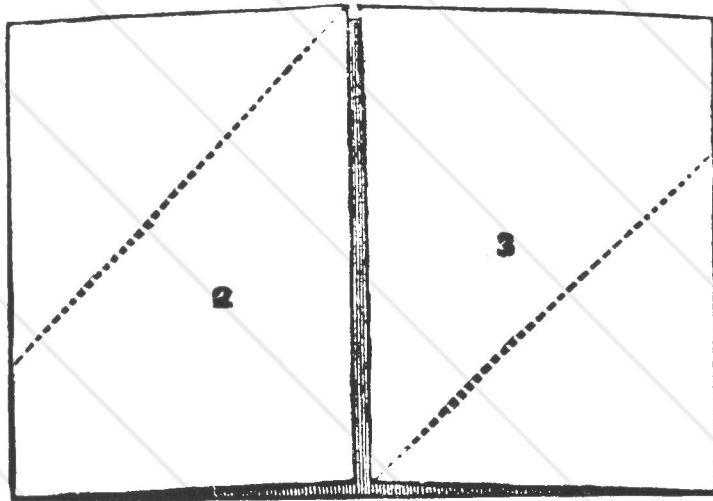

Diagram 2 & 3.—SHOWING THE 2ND AND 3RD FOLDS.

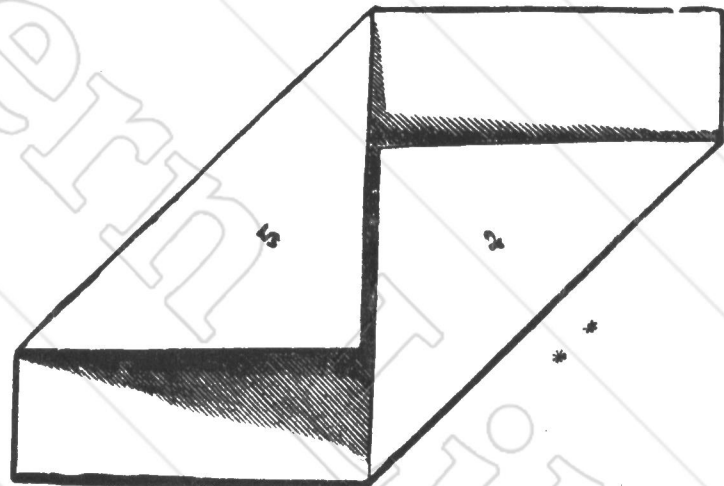

Diagram 4 & 5.—SHOWING THE 4TH AND 5TH FOLDS.

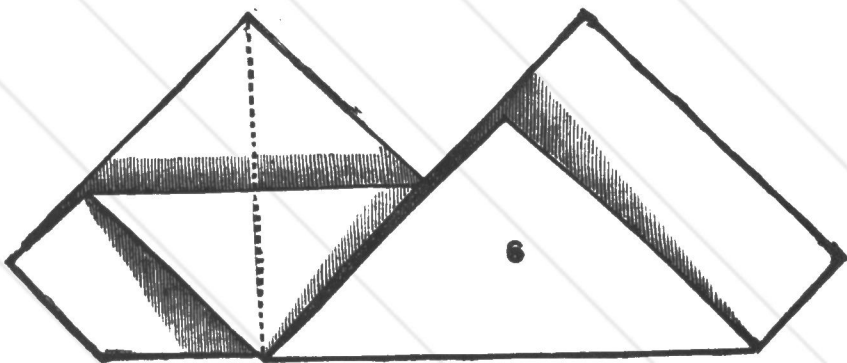

Diagram 6.—SHOWING THE 6TH FOLD.

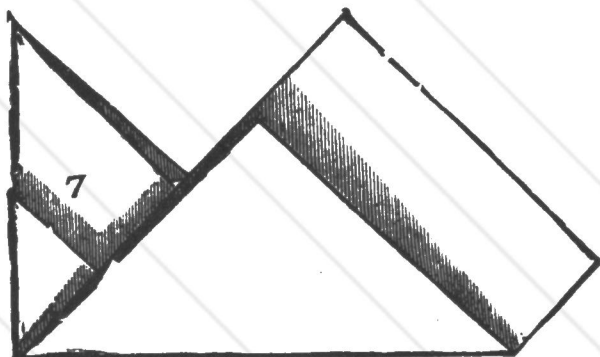
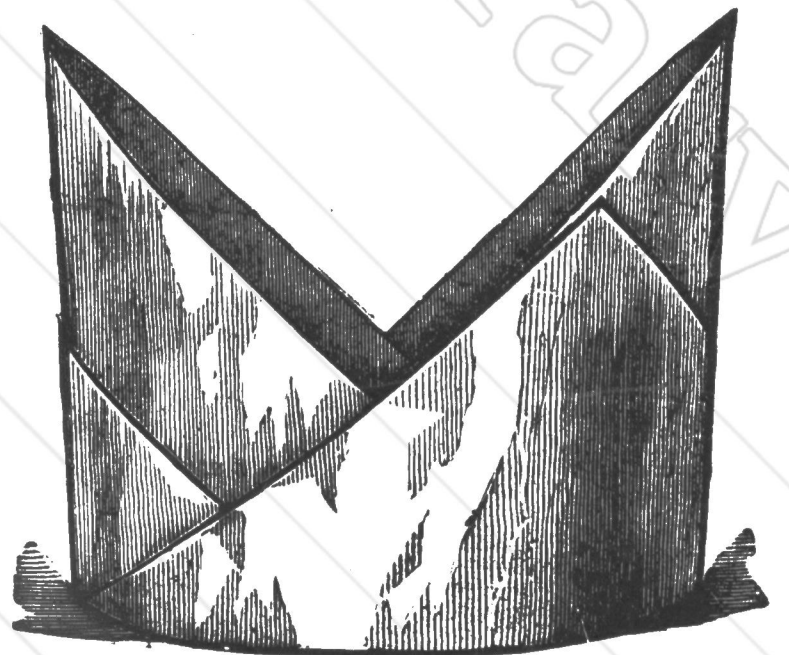

Diagram 7.—SHOWING THE 7TH FOLD.



No. 9.—THE SCROLL COMPLETED.

THE SCROLL DESIGN.

Weldon's Guide to Folding Serviettes.

It requires a well-stiffened finger napkin, which should be placed on the table before you in diamond shape, that is to say, with a corner top and bottom and one right and left. Diagram 1 shows the 1st and 2nd folds, which are accomplished by folding the left corner to the centre to form fold 1, then by folding the right corner to the centre fold 2 is arranged.

Now turn the napkin over from right to

left, which will still leave a corner top and bottom. Take the top corner and fold it down to the centre to make fold 3, then take the lower corner and fold it up to the centre to form fold 4, both of which are clearly shown by diagram 2, thus leaving the napkin square before you, while the dotted lines on diagram 2 denote where to make the next folds.

Now fold each of the 4 corners to the

centre as clearly shown in diagram 3, and which represents the 5th folds, the dotted lines giving the position for the 6th folds.

Turn the napkin over from right to left, still keeping it diamond shape, towards you, but bringing what was the underneath part to the top, and what was the top to the underneath. Fold each of the 4 corners to the centre again, as in diagram 4,

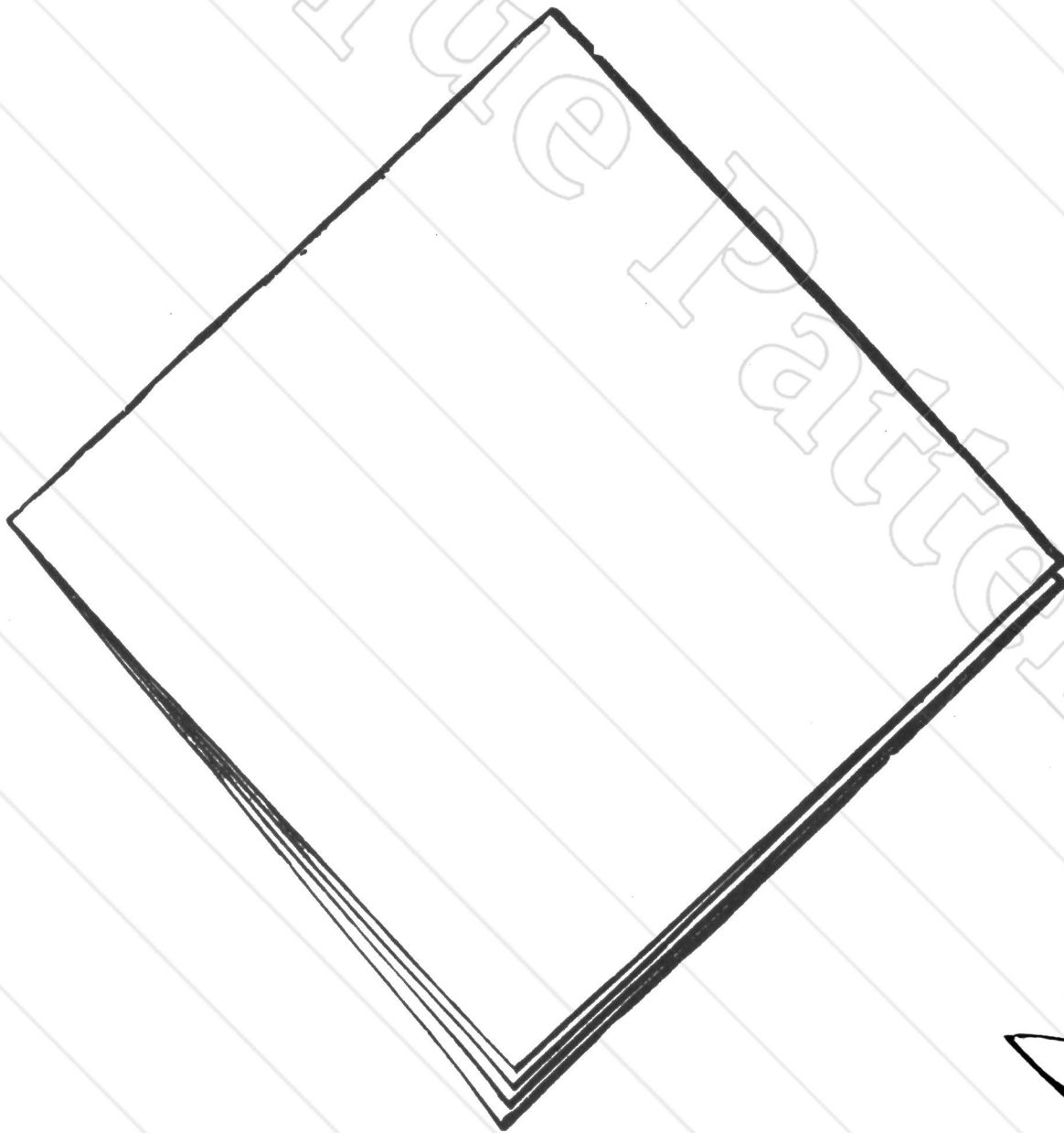

Diagram 1.—SHOWING THE 1ST FOLD.

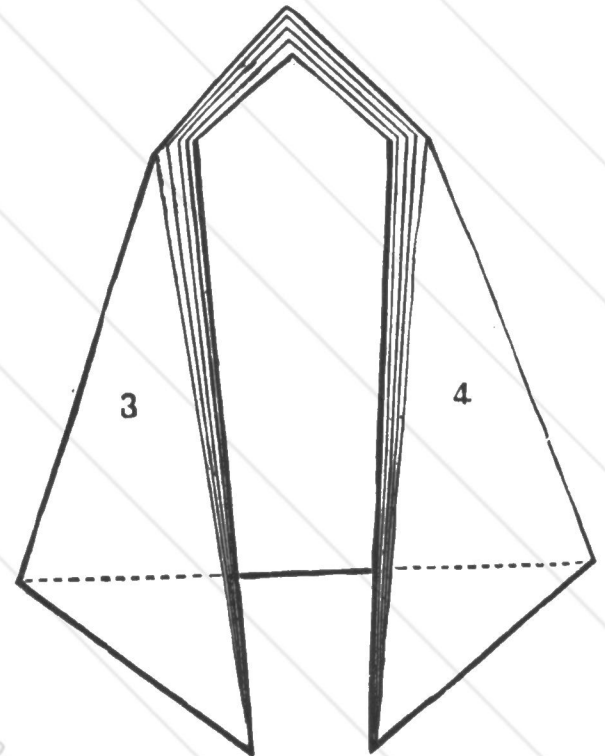
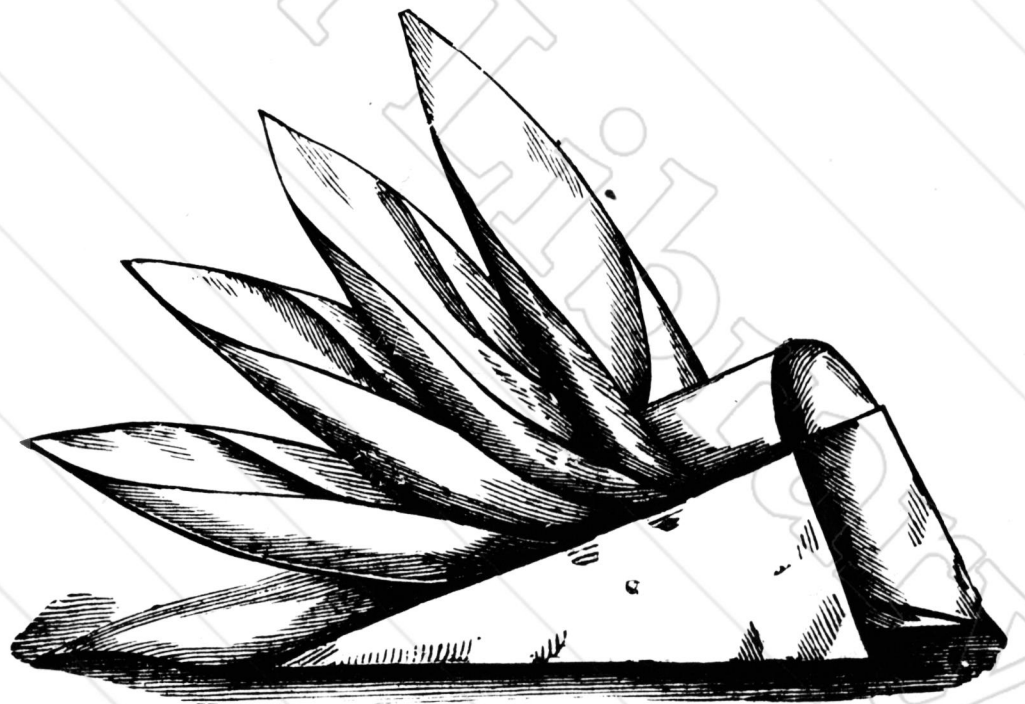

Diagram 3.—SHOWING THE 3RD AND 4TH FOLDS



Diagram 2.—SHOWING THE 2ND FOLD.



No. 5.—LILY LEAF DESIGN.

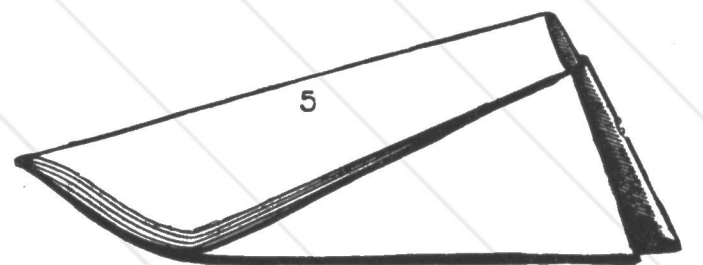

Diagram 4.—SHOWING THE 5TH FOLD.

LILY LEAF DESIGN.

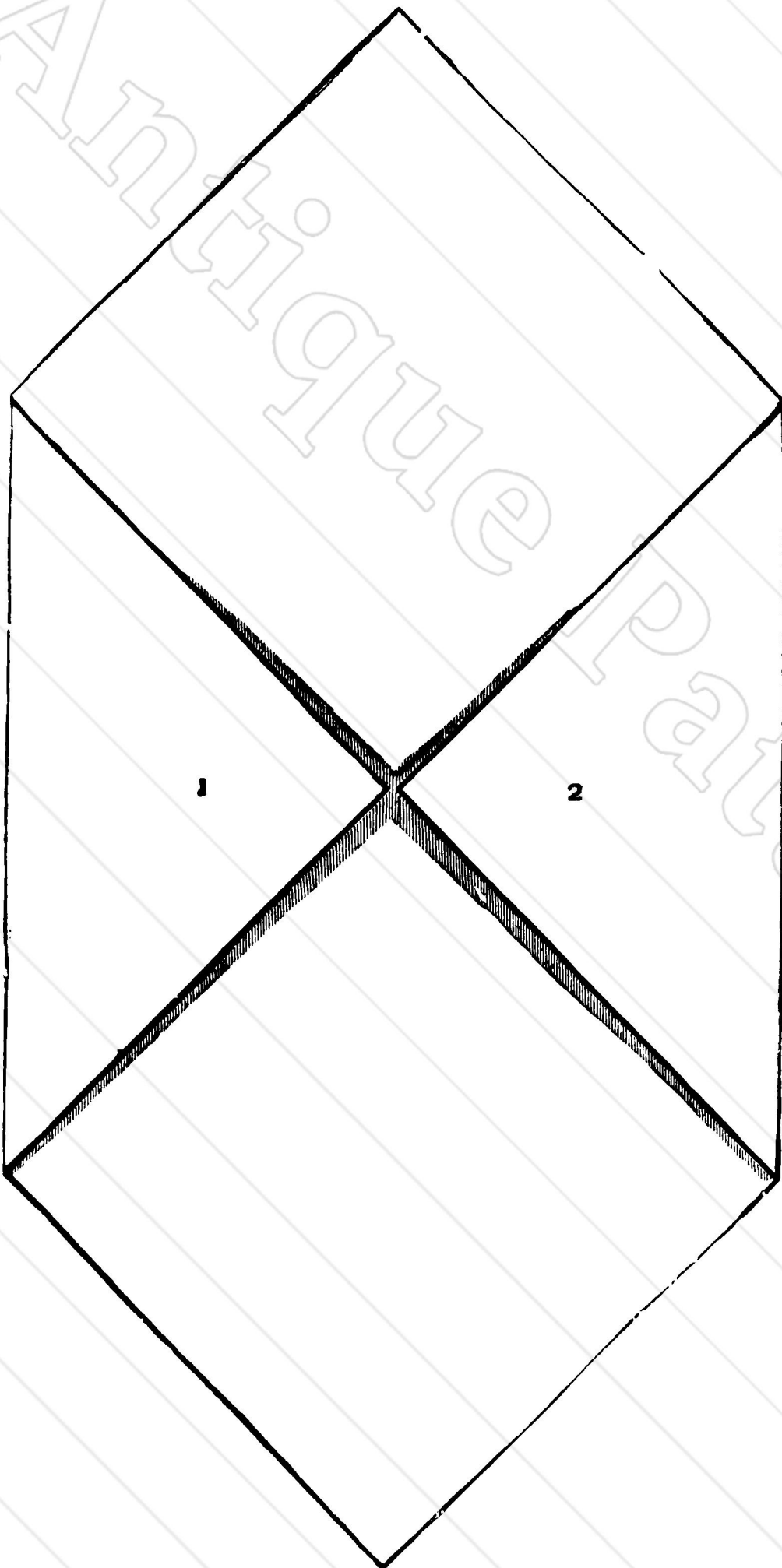

Diagram 1.—SHOWING THE 1ST AND 2ND FOLDS.

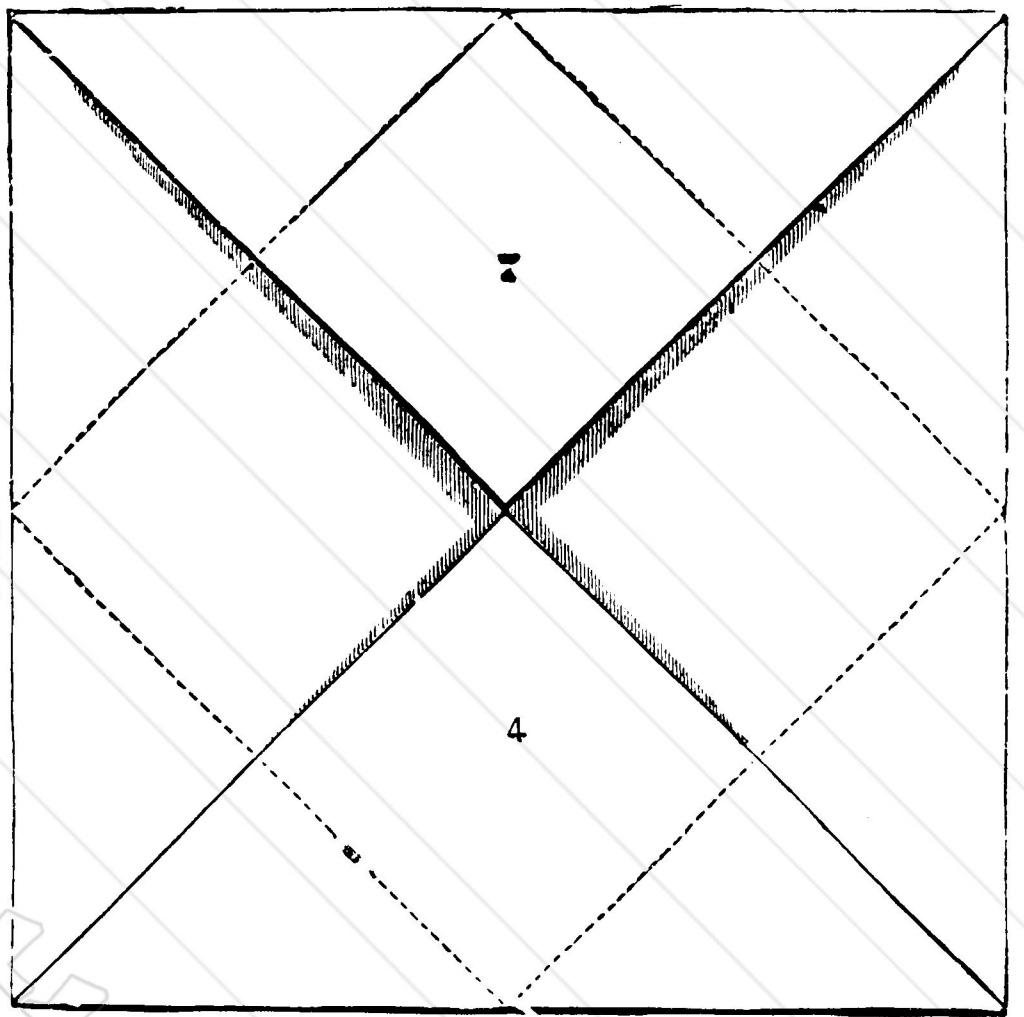

Diagram 2.—SHOWING THE 3RD AND 4TH FOLDS.

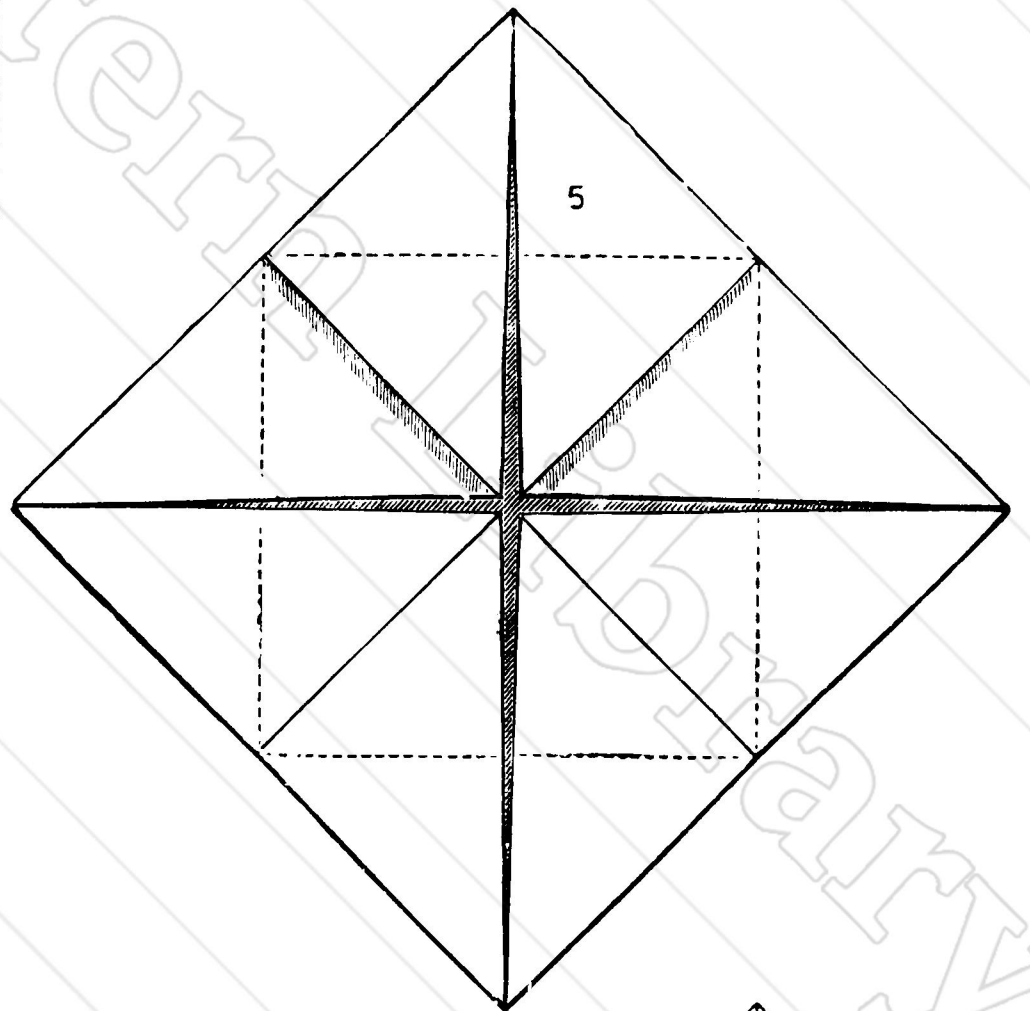

Diagram 3.—SHOWING THE 5TH FOLD.

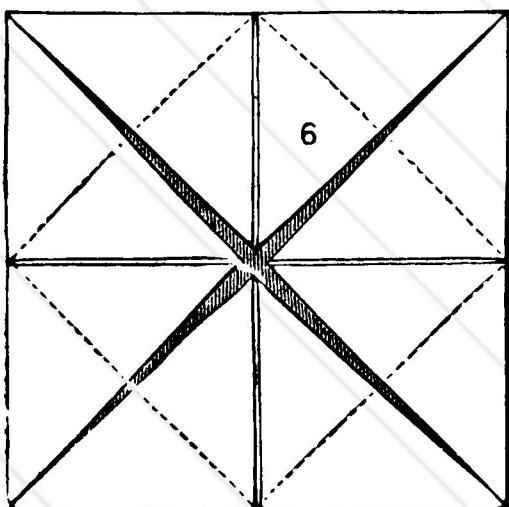
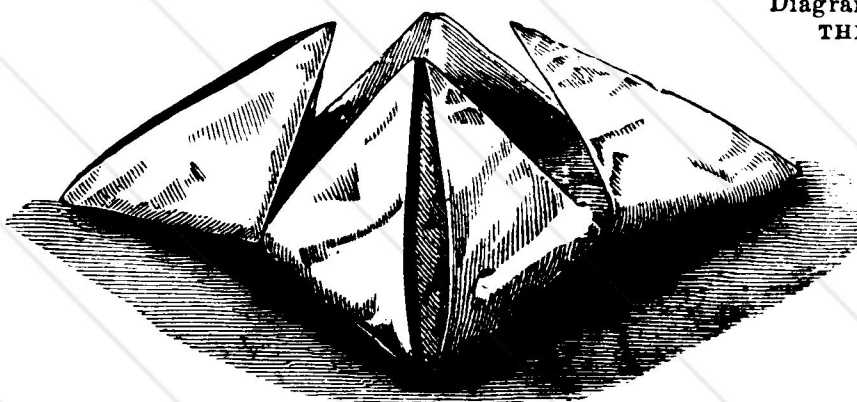

Diagram 4.—SHOWING THE 6TH FOLD.



NO. 6.—THE POCKET DESIGN.
POCKET DESIGN.

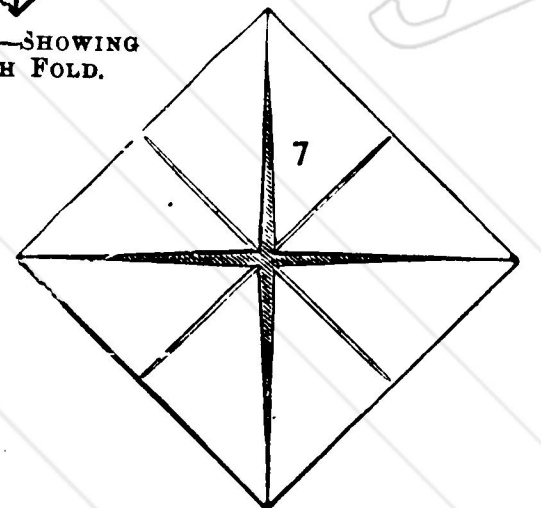

Diagram 5.—SHOWING THE 7TH FOLD.



Diagram 2.—SHOWING THE 2ND FOLD.



Diagram 1.—SHOWING THE 1ST FOLD.

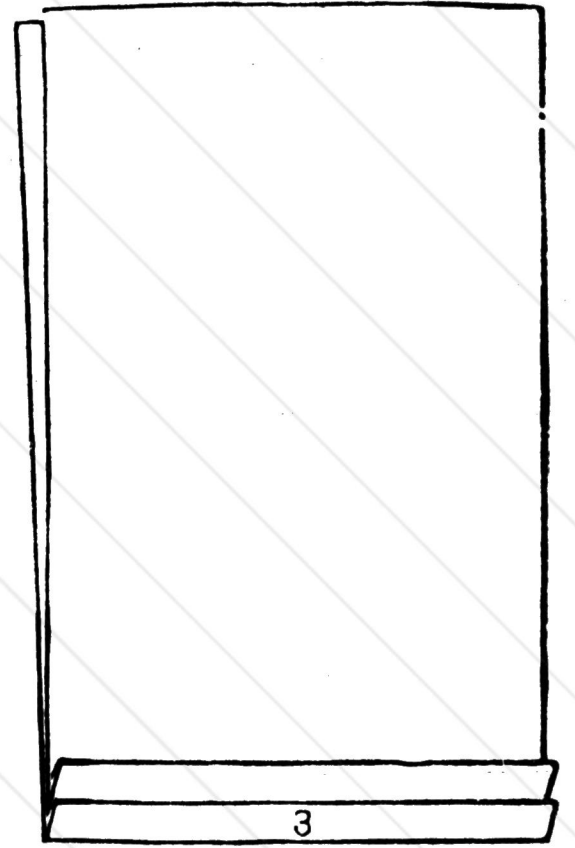

Diagram 3.—SHOWING THE 3RD FOLD.

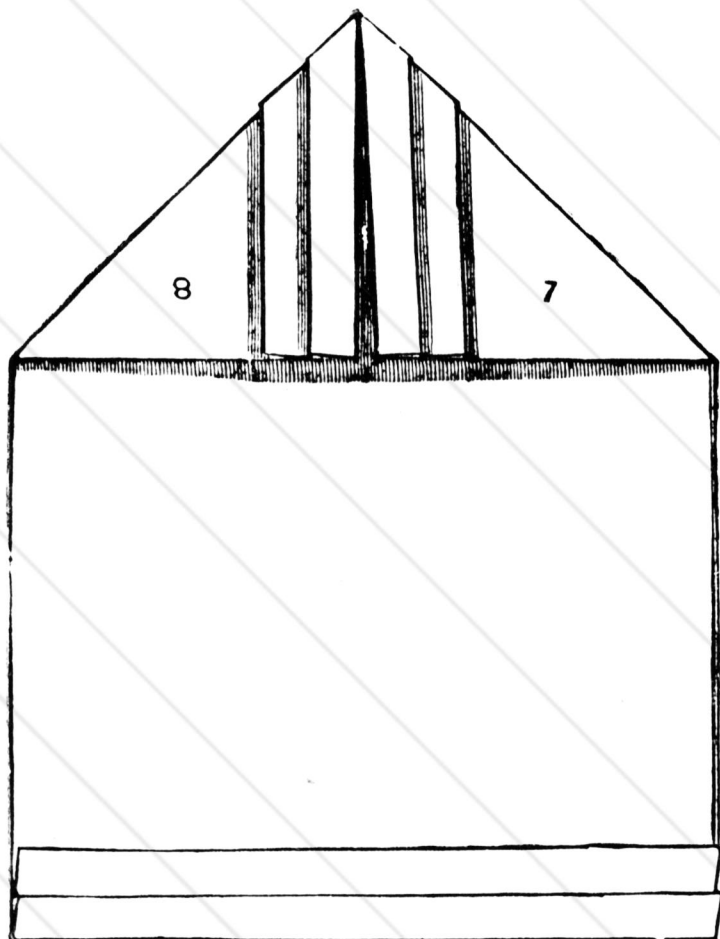

Diagram 4.—SHOWING THE 7TH AND 8TH FOLDS.

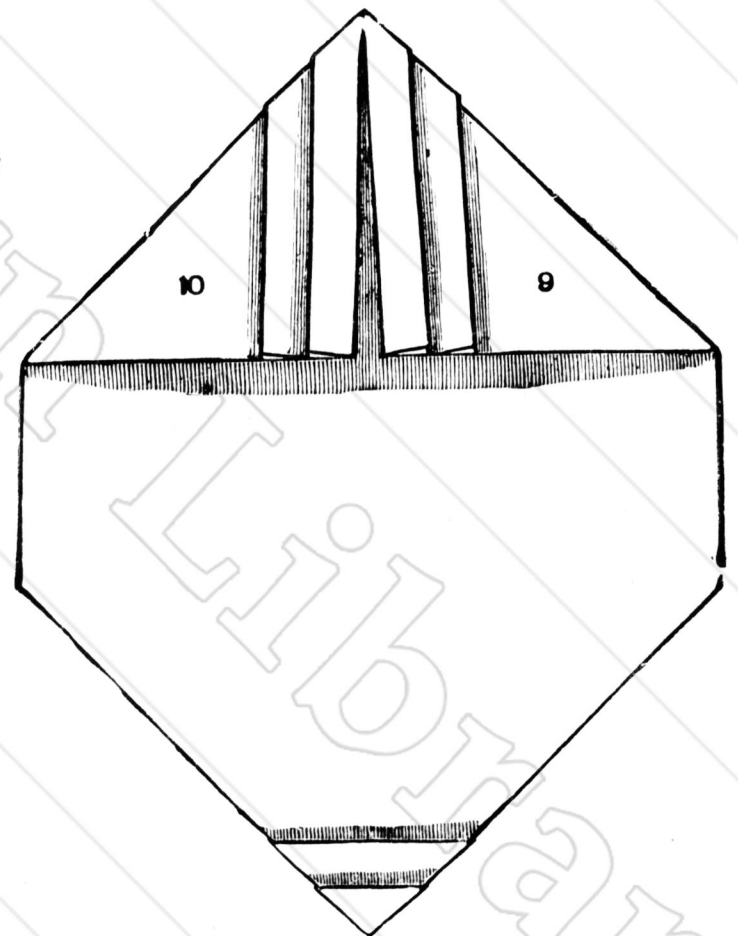
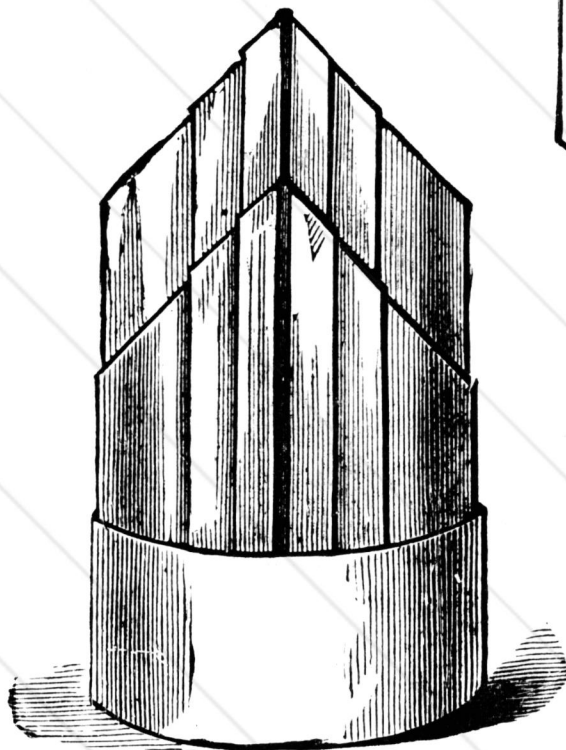

Diagram 5.—SHOWING THE 9TH AND 10TH FOLDS.



No. 8.—CARDINAL'S HAT.

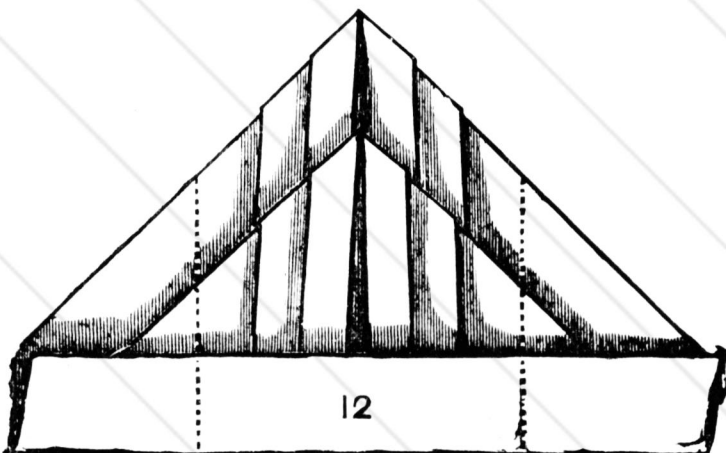

Diagram 7.—SHOWING THE 12TH FOLD.

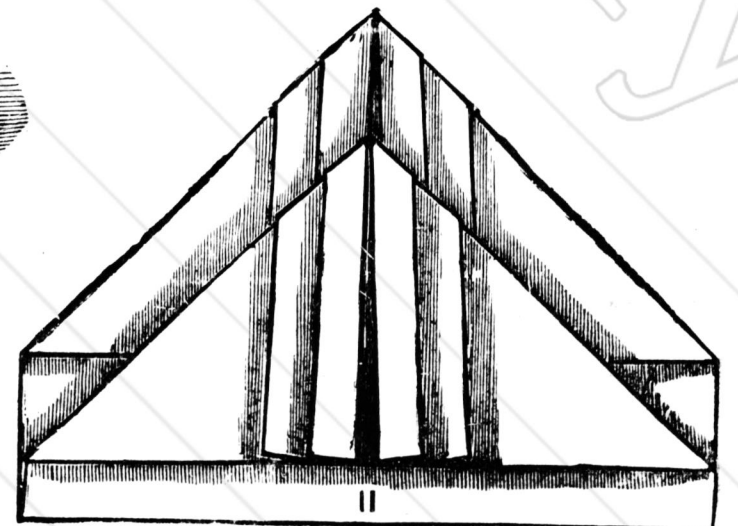

Diagram 6.—SHOWING THE 11TH FOLD.

CARDINAL'S HAT.

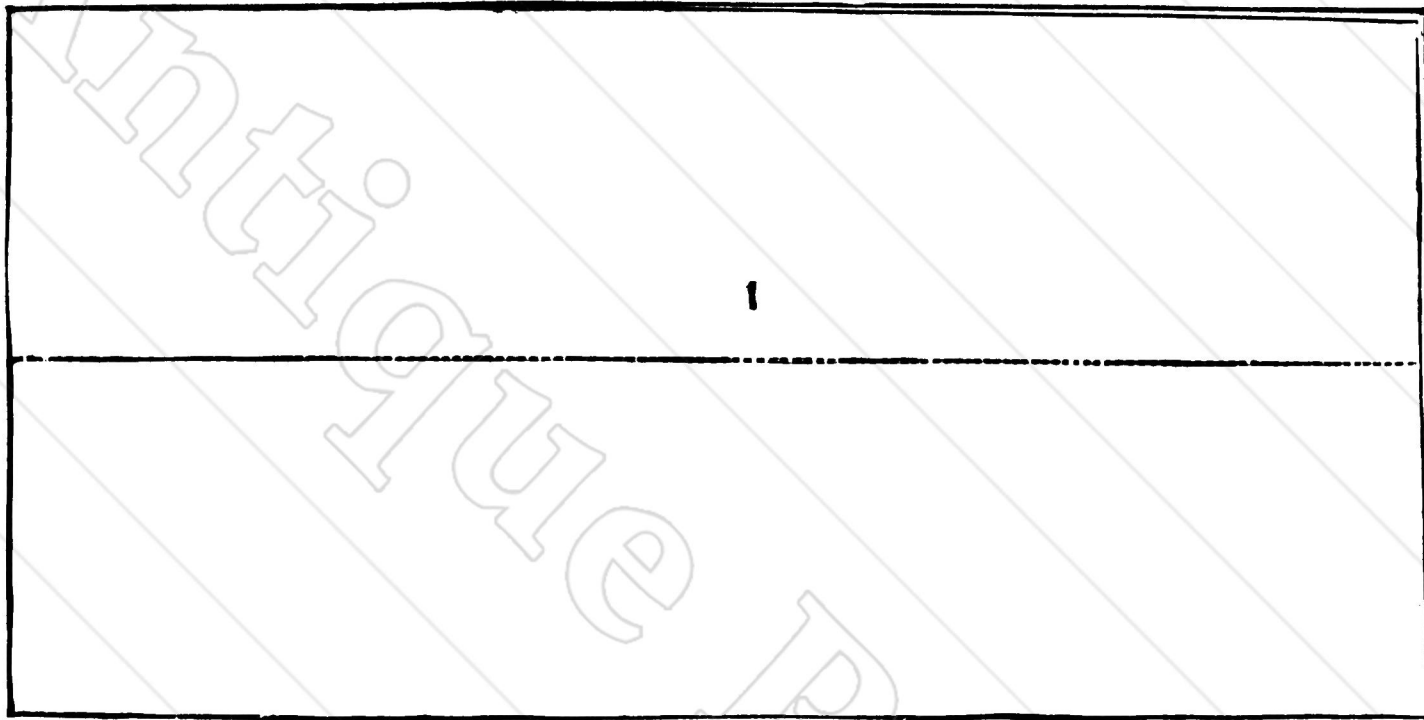

Diagram 1.—SHOWING THE 1ST FOLD.

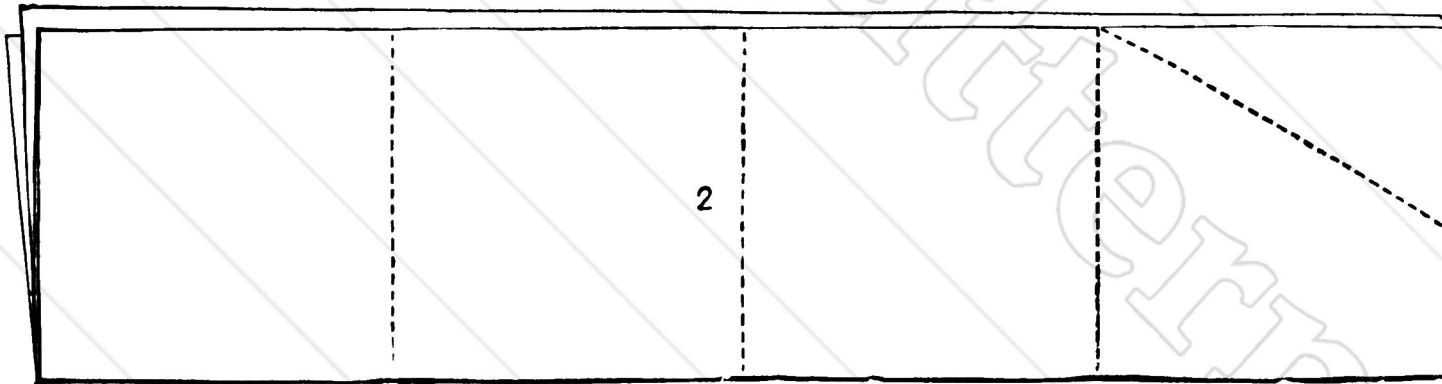

Diagram 2.—SHOWING THE 2ND FOLD.

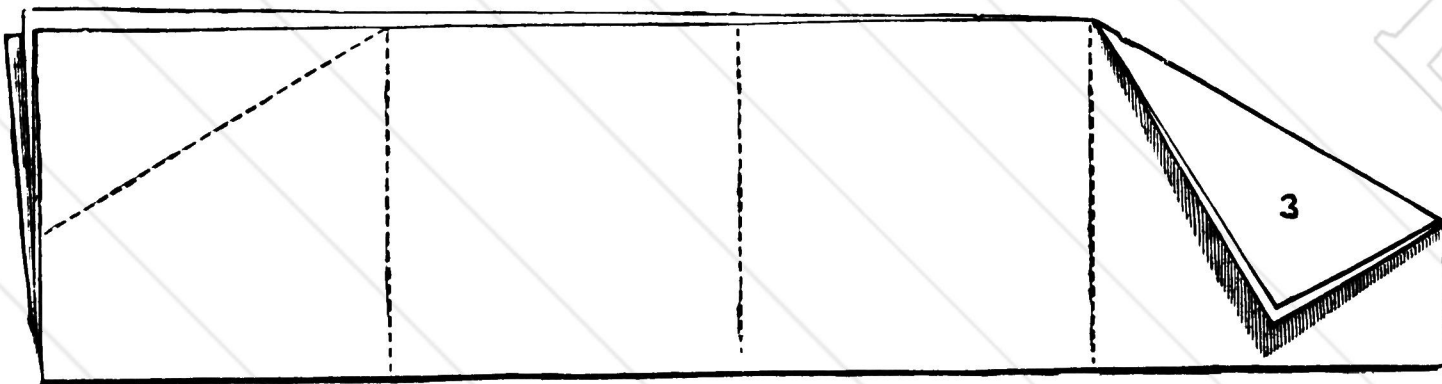

Diagram 3.—SHOWING THE 3RD FOLD.

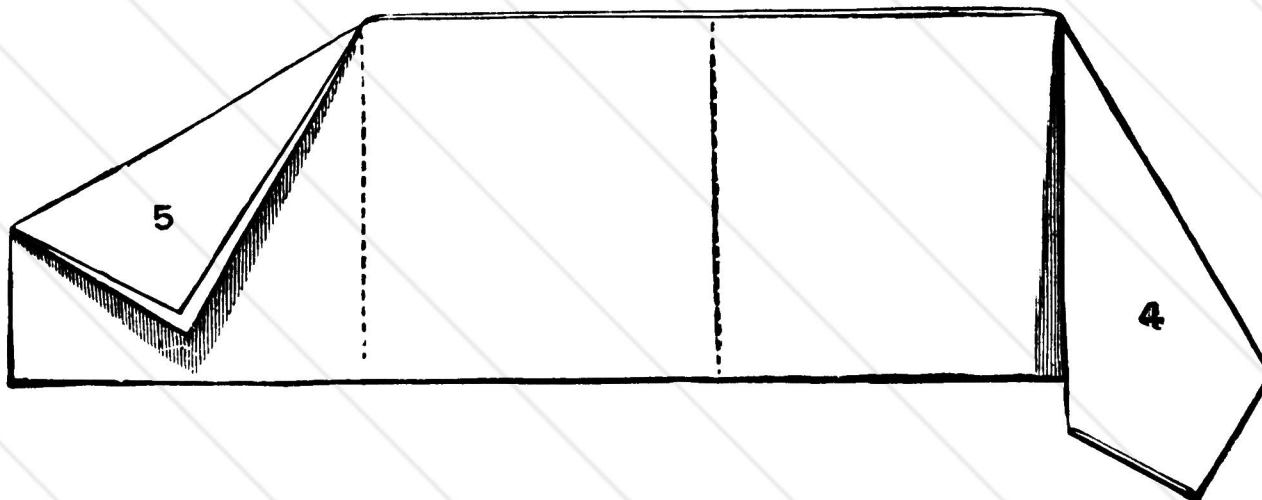

Diagram 4.—SHOWING THE 4TH AND 5TH FOLDS.

Diagrams for the Double Pocket Design.

which shows the 6th folds, bringing the napkin square before you.

Turn the napkin over from right to left, so as to bring the underneath part to the top, and again turn in all 4 corners to the centre, as shown in diagram 5, and which shows the 7th folds. Press these well, and turn the napkin over again, when you will be able to raise the corners to set them out as shown by illustration 6, and which gives the pocket design in its completed state. This design is most simple to arrange, as it is merely folding the corners each time to the centre, taking care, however, to turn the napkin right over from right to left after the 2nd, 5th, and 6th folds.

THE CARDINAL'S HAT.

For this attractive design a 27-inch square finger napkin is desired, and one that is well stiffened, so that it will stand up nicely. The first thing to be done is to fold the napkin in half, bringing the two hems together on the left-hand side. 1st fold—Take the lower edge of napkin and fold it up to the depth of about half an inch (see diagram 1). 2nd fold—Fold the napkin up again to the depth of 2 inches, the dotted line in diagram 1 showing the position of the second fold, which, when done, appears like diagram 2. 3rd fold—The dotted line in diagram 2 denotes where to turn up the napkin to the depth of about half an inch, to form the 3rd fold, as shown by diagram 3, and which, when done, lends the effect of a hem and tuck. Having pressed these folds thoroughly, so that they may retain their position, turn the napkin over, so that these folds are at the top, and face downwards on the table. Now to form folds 4, 5, and 6, repeat folds 1, 2, and 3, as both ends must be made alike, one having the folds on the top, and the reverse end with the folds underneath. 7th and 8th folds—

These are arranged by bringing the top right-hand corner over in triangle shape, as shown by fig. 7, in diagram 4, then bring the top left-hand corner over to correspond, as shown by fig. 8 in same diagram. 9th and 10th folds—Turn the napkin over, bringing the straight or lower end shown in No. 4 to the top, then fold down the top right corner in a

triangle, as shown by fig. 9 in diagram 5; after which repeat with other corner, as shown by fig. 10, and your napkin will resemble diagram 5. 11th fold—This is accomplished by simply turning the lower point of the napkin up to imitate diagram 6. 12th fold—Turn up the lower edge of napkin to form a band, the top of which

must meet the line made across napkin by folds 9th and 10th. No. 7 diagram denotes the 12th fold. 13th fold—Turn the two sides *under*, as shown by dotted lines on No. 7 diagram, when it will appear as No. 8, then slip one end into the band of the other, to keep it secure, when the Cardinal's Hat will be completed, and by pressing the sides

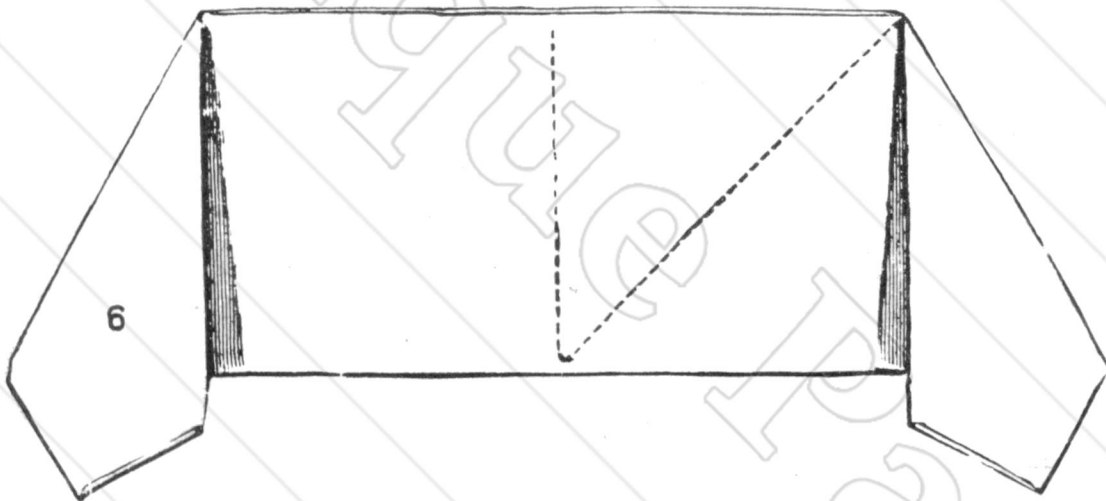

Diagram 5.—SHOWING THE 6TH FOLD.

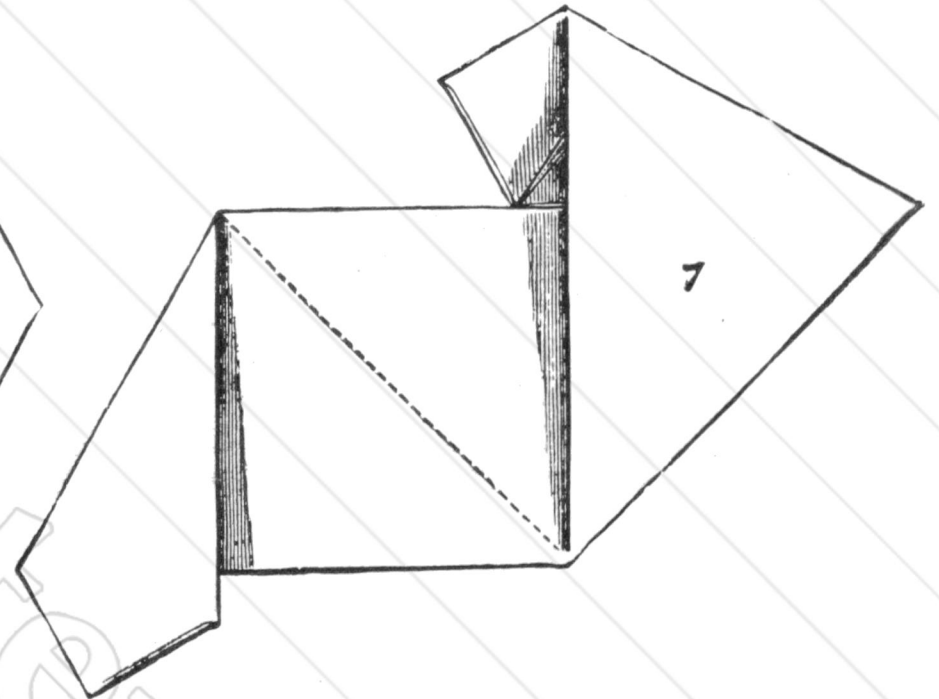
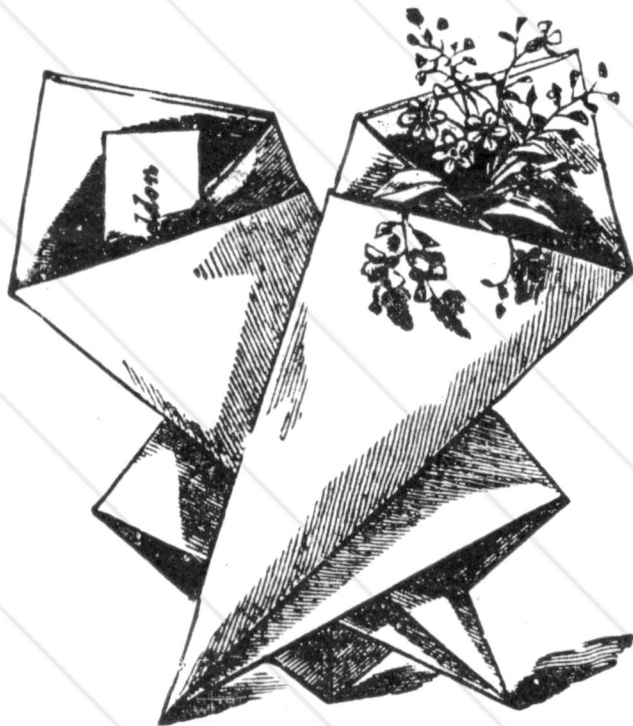

Diagram 6.—SHOWING THE 7TH FOLD.



No. 12.—DOUBLE POCKET DESIGN.

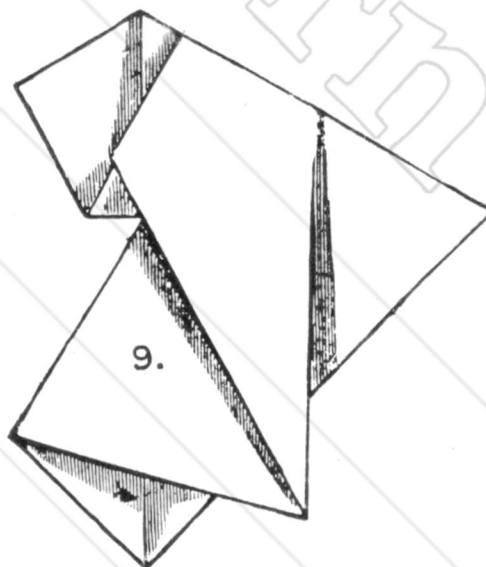

Diagram 8.—SHOWING THE 9TH FOLD.



Diagram 10.—SHOWING THE 11TH FOLD.

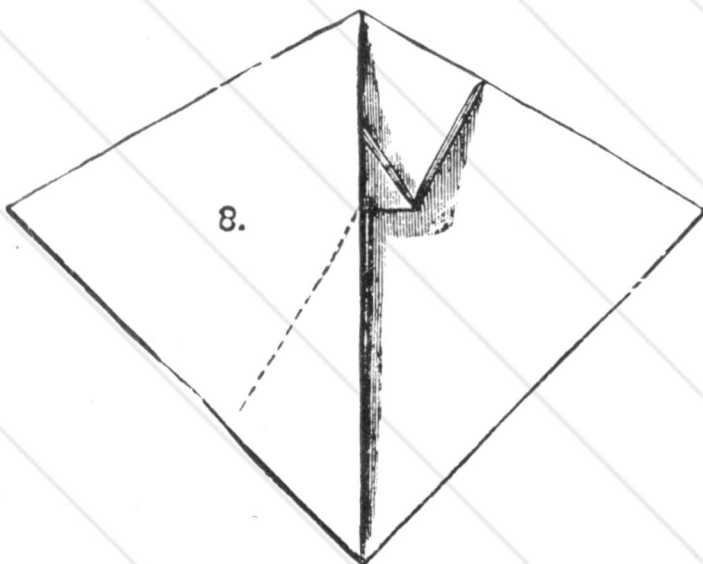

Diagram 7.—SHOWING THE 8TH FOLD.

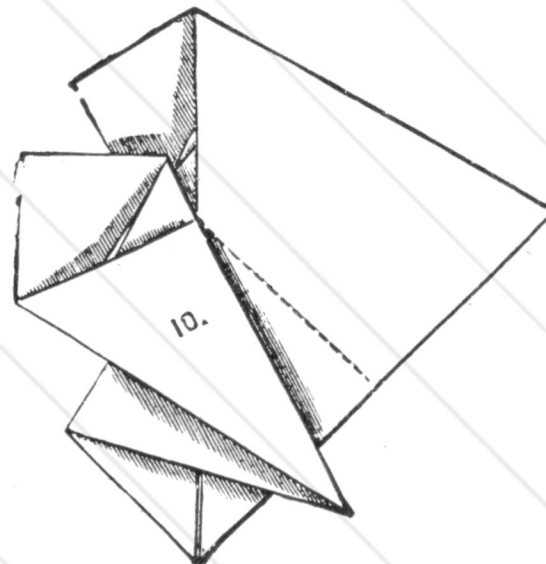

Diagram 9.—SHOWING THE 10TH FOLD.

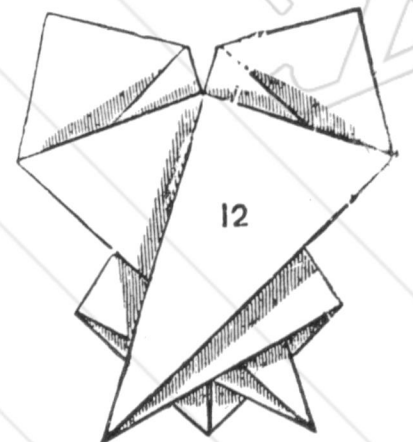

Diagram 11.—SHOWING THE 12TH FOLD.

DOUBLE POCKET DESIGN.

Weldon's Guide to Folding Serviettes.

a little to give it a slight roundness, it will stand on the table, as illustration 8 denotes, while the bread can be placed inside.

THE DOUBLE POCKET DESIGN.

This design, although it may look a little complicated at first sight, is one that can soon be accomplished, and it is exceedingly novel as well as ornamental and useful, since one pocket holds the guest card and the other a spray of flowers, or these can be dis-

gram 1, by a dotted line just beneath the fig. 1. Then mark the napkin lengthways in four equal parts, as clearly shown by the dotted lines, and which are required as a guide for the other folds later on.

Diagram 3, showing the third fold, has simply to have the upper right-hand corner turned down, as clearly illustrated by the corner marked with the fig. 3.

Diagram 4 shows the fourth fold, arranged by turning the same corner used for the third

side of this diagram denotes the position for the next fold.

Diagram 6 shows the seventh fold accomplished, which is simply done by folding the right-hand side of the finger napkin up, so as to bring the lower edge to meet the dotted line through the centre. (Shown in diagram 5).

Diagram 7 denotes the eighth fold, which is a repetition of what has just been done, but arranged by folding up the left-hand side, as denoted by the dotted line on

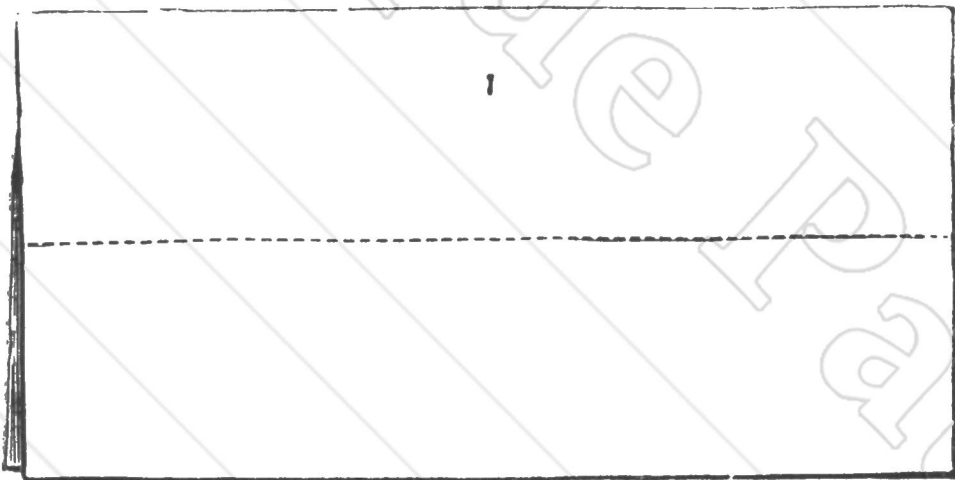

Diagram 1.—SHOWING THE 1ST FOLD.

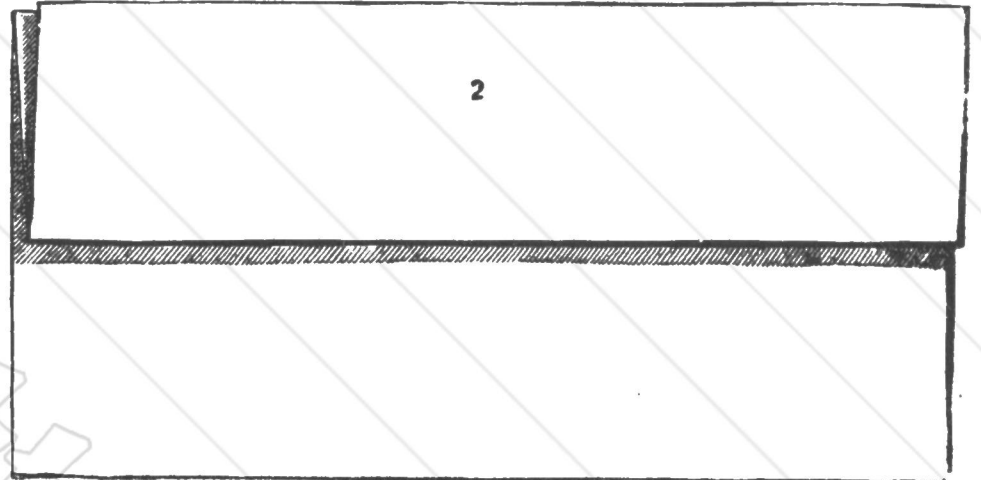

Diagram 2.—SHOWING THE 2ND FOLD.

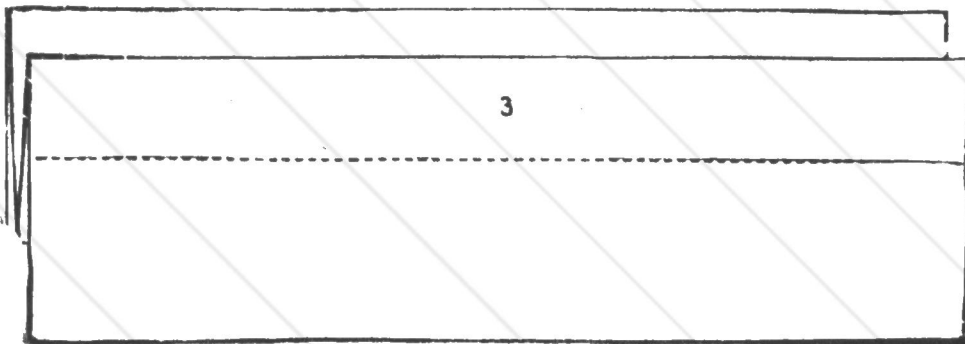

Diagram 3.—SHOWING THE 3RD FOLD.

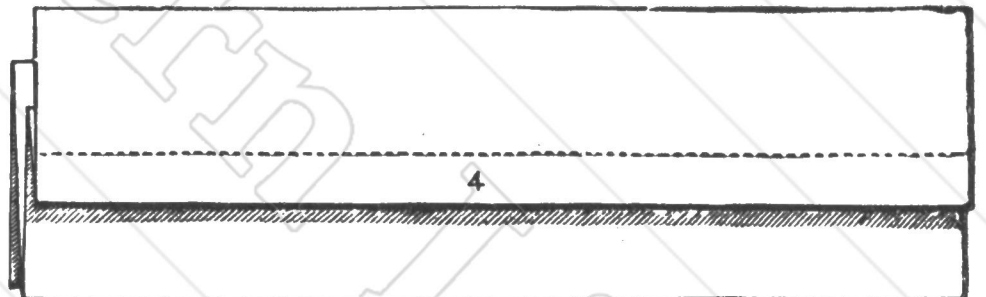

Diagram 4.—SHOWING THE 4TH FOLD.

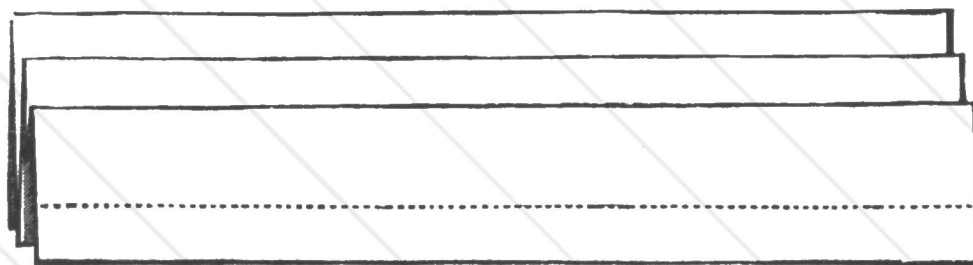

Diagram 5.—SHOWING THE 5TH FOLD.

Diagrams for the Banded Scroll Design.

pensed with if desired, as the napkin is quite complete in itself, and stands firmly on the table, forming a pretty variation to the designs already given.

Diagram 1 shows the first fold, for which a well-stiffened napkin is required, and which has to be folded in half, so as to bring the two edges at the top and fold at the bottom.

Diagram 2 denotes the second fold, which is simply done by folding the napkin up again through the centre, as denoted on dia-

fold down again, to bring it level with the right-hand dotted line shown on diagram 3.

Diagram 4 also gives the fifth fold, and which is really a repetition of the third fold, only arranged from the left-hand upper corner, as denoted on the diagram by the figure 5.

Diagram 5 shows the sixth fold, which is accomplished by turning down the same corner again to bring it level to the left-hand dotted line shown on diagram 4, while the diagonal dotted line on the right-hand

diagram 6, and which brings the lower edge of the napkin to the centre, when it will appear just like diagram 7. Now fold the finger napkin over to the right, as denoted by the dotted line, made rather slantwise, beneath the fig. 8, in diagram 7, when it will appear like diagram 8, and which shows the ninth fold.

Diagram 9 shows the tenth fold, arranged by folding back the pocket, when it will appear like diagram 9, thus completing the left-hand pocket.

Diagram 10 shows how the eleventh fold is made by folding the right-hand side of the napkin over to the left, as clearly denoted by a dotted line on diagram 9 just above the fig. 10.

Now take the pocket and fold it back to the right, when it will appear as diagram 11, which shows the twelfth and last fold. Press the folds well before taking the napkin up from the table, then insert the hand in the

banded scroll design, which requires a moderately stiff serviette or finger napkin to accomplish it successfully. Very little, if any, difficulty will be met with in undertaking this design, since every fold is most accurately and clearly illustrated.

Diagram 1 denotes the first fold, which is arranged by folding the napkin directly in half, letting the fold remain at the top and the two edges towards you

upon looking at the folds on the left-hand side. Just below the fig. 3 in this diagram will be seen a dotted line which denotes the position for the fourth fold.

Diagram 4 shows the fourth fold executed, which is done by turning back the napkin at the dotted line in diagram 3, to make it appear as diagram 4.

Diagram 5, showing the fifth fold, is merely done by turning the napkin down

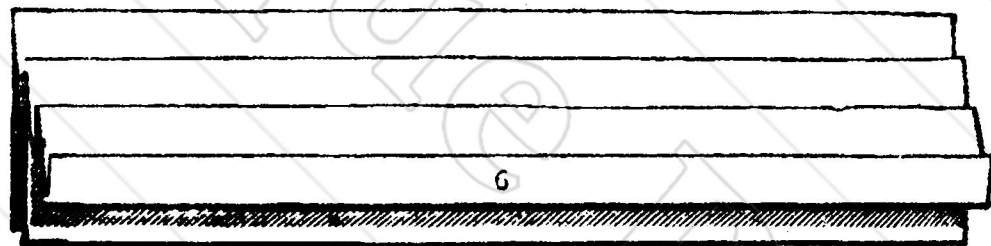

Diagram 6.—SHOWING THE 6TH FOLD.

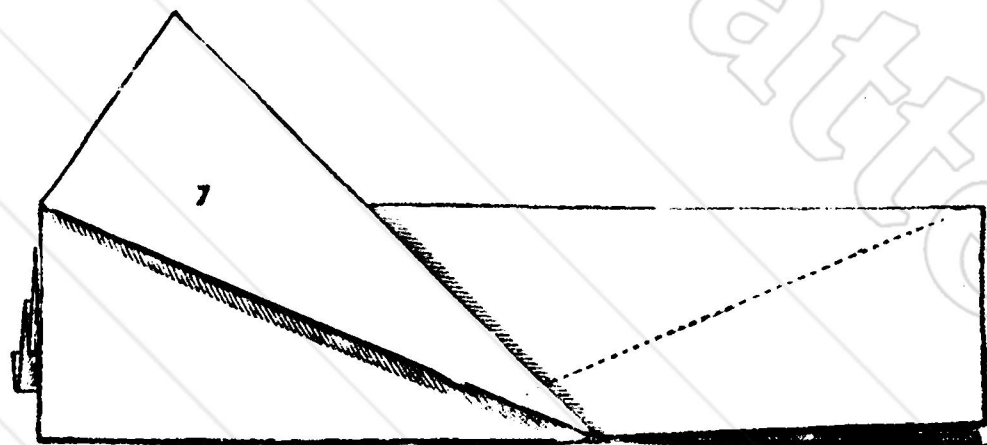

Diagram 7.—SHOWING THE 7TH FOLD.

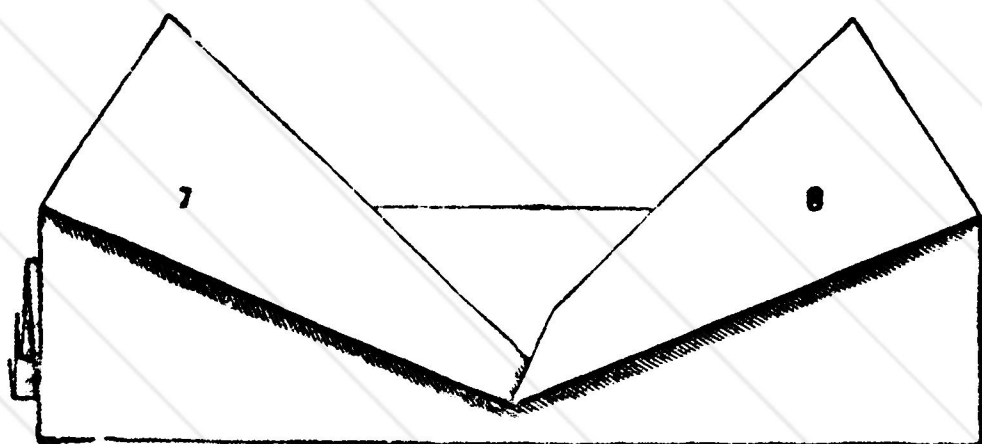
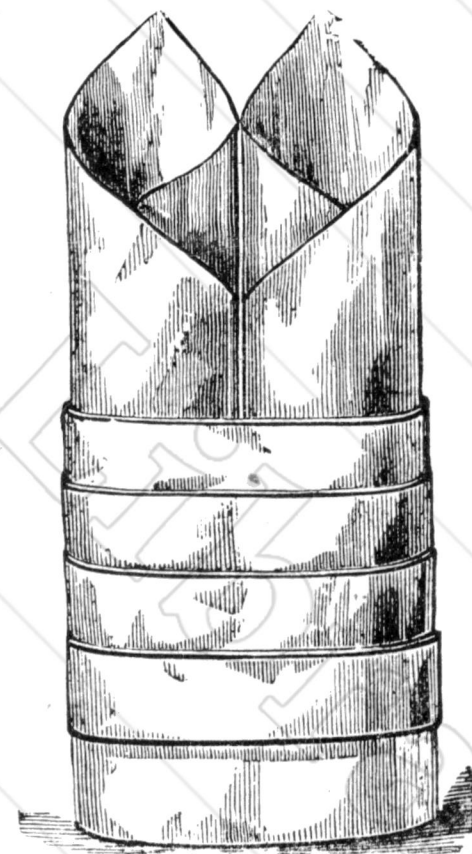

Diagram 8.—SHOWING THE 8TH FOLD.



Diagram 9.—SHOWING ONE END ROLLED TO FORM THE BANDED SCROLL.



No. 10.—BANDED SCROLL.

BANDED SCROLL DESIGN.

pockets to bend them a little round, and press the lower part a little open to enable it to stand upright on the table, as shown by illustration 12.

A complete set of paper patterns, showing every fold, including the make-up model of the double pocket design, can be had for 7d., post free.

THE BANDED SCROLL DESIGN.

Simple to fold, yet very effective, is the

Diagram 2, showing the second fold, is simply done by turning up one of the sides of the finger napkin through the centre as the dotted line in diagram 1 denotes, when it will appear like diagram 2.

Diagram 3, which gives the third fold, is accomplished by first turning the napkin over from right to left, thus bringing what was formerly the underneath part to the top, and which is folded up and back again as is clearly shown by diagram 3, more especially

again according to the dotted line above the fig. 4 in diagram 4.

Diagram 6, which is the sixth and last fold for this side, is simply done by turning up the lower edge of the napkin as shown by the dotted line below the fig. 5 in diagram 5, when it will appear as diagram 6, and which completes the folds or bands round the scroll.

Now turn the finger napkin over from right to left, which will place the folds just

Weldon's Guide to Folding Serviettes.

made to the underneath part, and bring what was originally the under part to the top.

Diagram 7 shows the seventh fold arranged by turning up the left-hand side of the napkin slantwise to a trifle beyond the centre, as shown in diagram by the fold centred with the fig. 7, while the dotted line made slantwise from upper right-hand corner to just beyond the centre denotes the position for the next fold.

Diagram 8 illustrates the eighth fold completed, and which is arranged by turning up

the rolls nicely, while it is a quickly executed as well as an effective pattern. This design has a pretty effect if used with the scroll, mitre, or double pocket design, putting this banded scroll design alternately with the mitre pattern, etc.

THE MITRE DESIGN.

A square finger napkin is necessary for this pattern, and having opened it quite flat upon the table, proceed as follows: Diagram 1, which represents the first fold, is made by

upper part quite flat. Diagram 5. Take the top point and fold it down on to the bottom point, thus exposing the whole of the two thicknesses of the napkin, as clearly shown in diagram 5. Diagram 6. Turn the napkin entirely over from right to left, thus bringing what was the under part to the upper part; then take the top right-hand corner and fold it down to the centre, then repeat with the top left-hand corner, when it will appear as diagram 6. Diagram 7. Fold the right-hand corner over nearly to the centre.

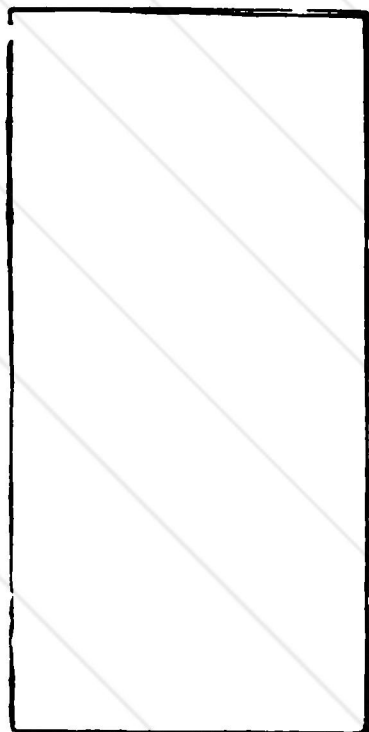

Diagram 1.—1ST FOLD FOR MITRE.



Diagram 2.—2ND FOLD FOR MITRE.

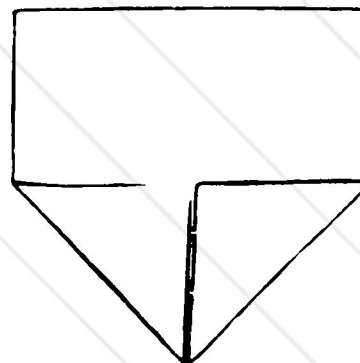

Diagram 3.—3RD FOLD FOR MITRE.

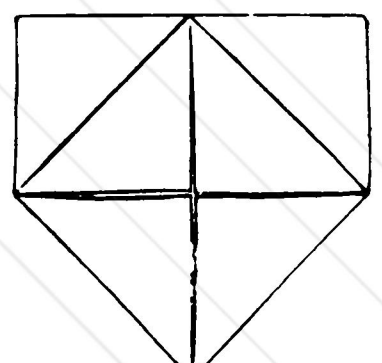

Diagram 4.—4TH FOLD FOR MITRE.

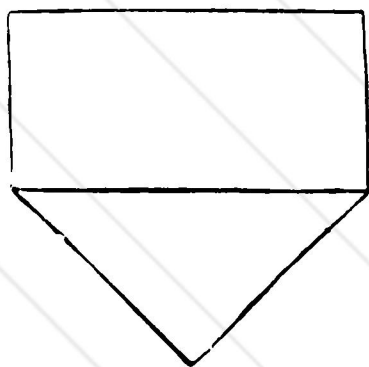
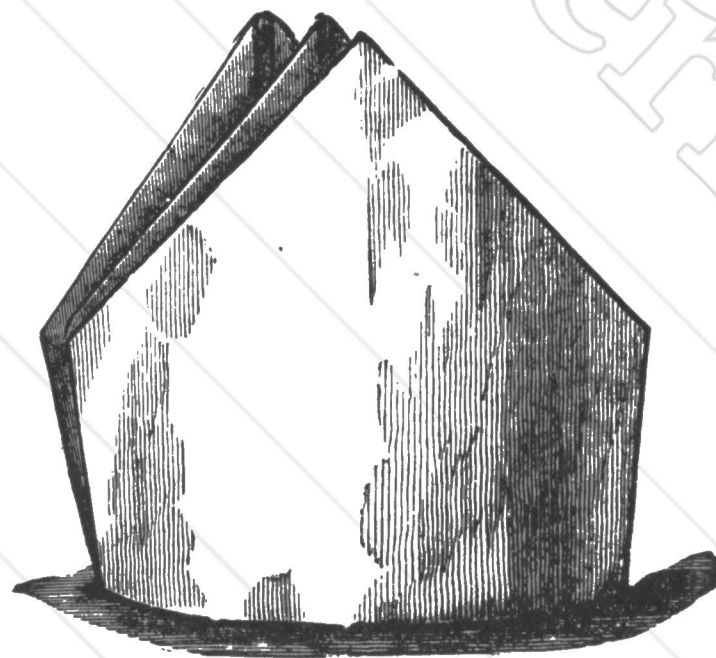

Diagram 5.—5TH FOLD FOR MITRE.



No. 9.—THE MITRE DESIGN.

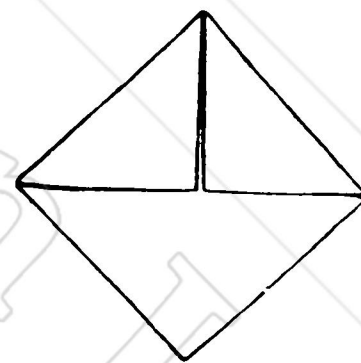

Diagram 6.—6TH FOLD FOR MITRE.

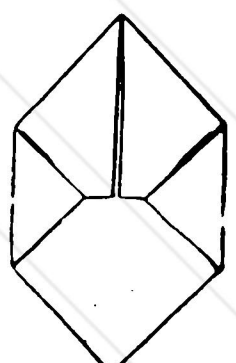

Diagram 7.—7TH FOLD FOR MITRE.



Diagram 8.—8TH FOLD FOR MITRE.

THE MITRE DESIGN.

the right-hand corner of napkin to resemble the part marked with the fig. 8.

Diagram 9 shows one end of the napkin rolled to form the right-hand scroll, which is accomplished by turning the napkin over from right to left, so as to bring the folds forming the bands to the top; then commence rolling the napkin up from the right side as far as the centre to form an organ-like flute; after which repeat with the other end, and press the rolls carefully to keep them in place, when the napkin will stand up firmly as illustrated by No. 10. A little practice will soon enable one to accomplish

folding the napkin in half from left to right. Diagram 2. Fold the napkin upwards in half to form a square. Diagram 3. For this it is necessary to find the exact centre of the square, and to this fold the right-hand bottom corner to bring the point to the centre, then repeat with left-hand lower corner, which will form two half-diamonds, as clearly shown by diagram 3. Diagram 4. Take two thicknesses of the napkin and fold the top right-hand corner over to bring it to the centre, and repeat with left-hand corner, thus there are four points folded to the centre, leaving two thicknesses of the napkin at the

then repeat with left-hand corner to bring them like diagram 7. Diagram 8. Now take the lower part and fold it up to the top point, pressing the napkin thoroughly, so that it may retain its folds, when it will appear just like diagram 8, and along the bottom, where the straight line is shown, insert the hand between the folds, when the mitre can be expanded sufficiently to give it a roundness, and to stand it on the table, as represented by diagram 9.

A complete set of paper patterns, showing every fold of the Mitre design, can be had for 7d., post free.

The Hood or Pocket Design

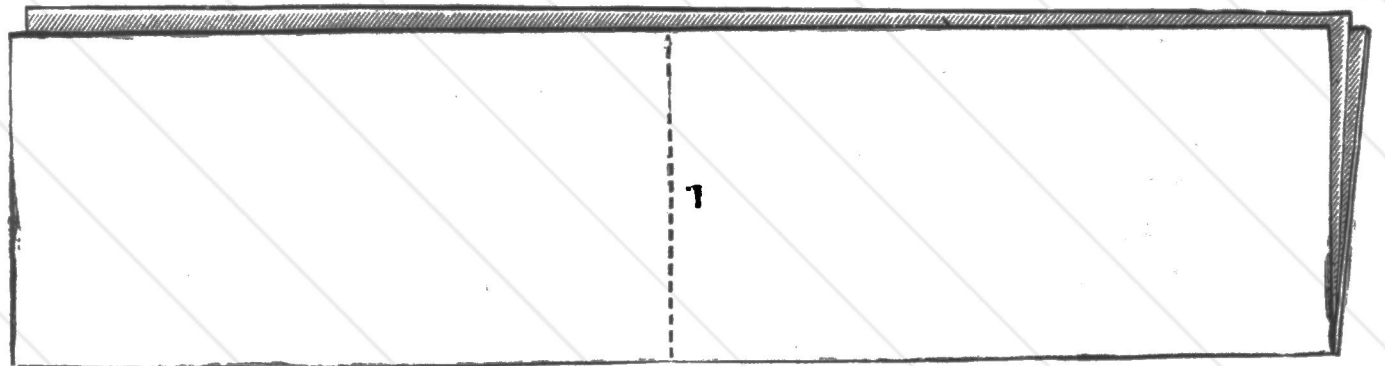

Diagram 1.—THE SERVIETTE FOLDED IN THREE EQUAL PARTS.

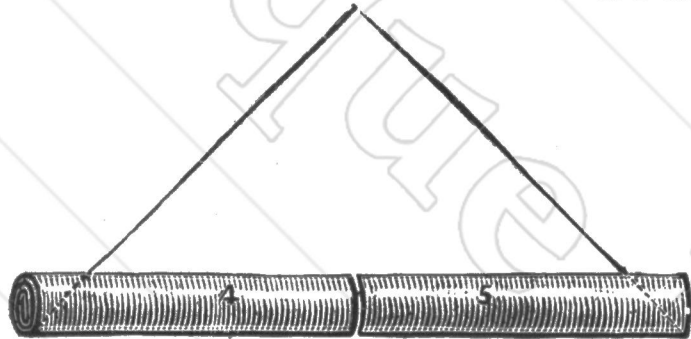

Diagram 4.—THE ENDS ROLLED UP.

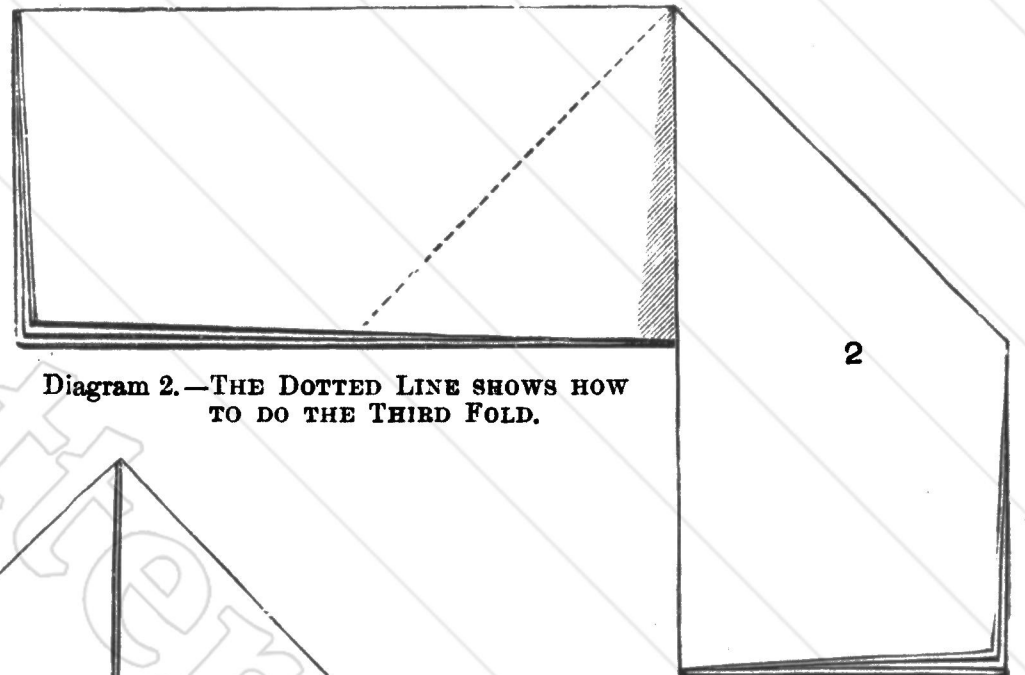

Diagram 2.—THE DOTTED LINE SHOWS HOW TO DO THE THIRD FOLD.

THE SECOND FOLD.

Use a well-stiffened square or oblong serviette, an oblong one is preferable.

Place serviette with longest way from left to right, and fold it in three equal parts, as diagram 1.

Fold down the right-hand side as diagram 2; the slantwise dotted line on the left-hand side showing third fold, as diagram 3.

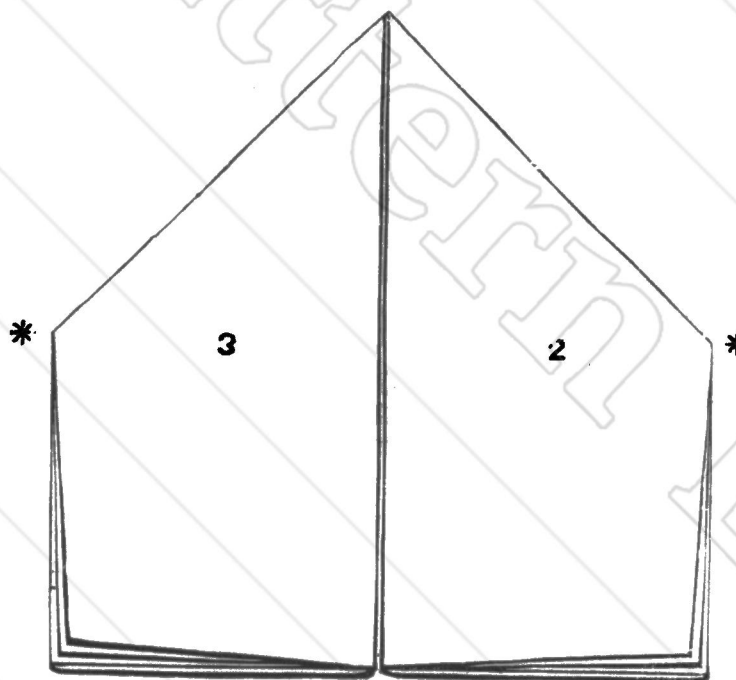

Diagram 3.—THE SECOND AND THIRD FOLDS COMPLETED

Turn the serviette over from right to left, then roll up and press well each of the ends as far as the star on either side of diagram 3.—Also see diagram 4.

Turn the serviette over so that the point is directly before you. Take the top left-hand corner and roll so that a roll goes down centre, as diagram 5. Then roll the other side to correspond, when it will appear as diagram 6.

Well press these rolls, turn the serviette over, and open the mouth or hood part, as completed sketch, the mouth opening forming a receptacle for the bread.

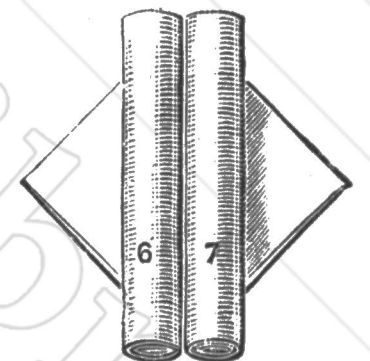

Fig. 6.—THE TWO ROLLS COMPLETED.

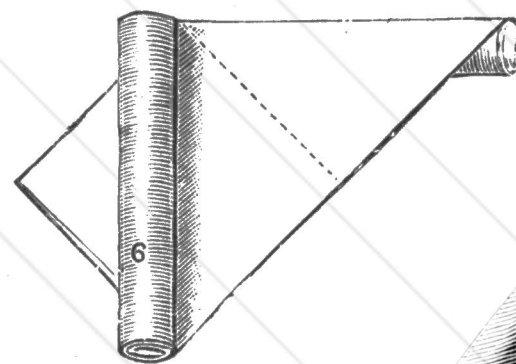
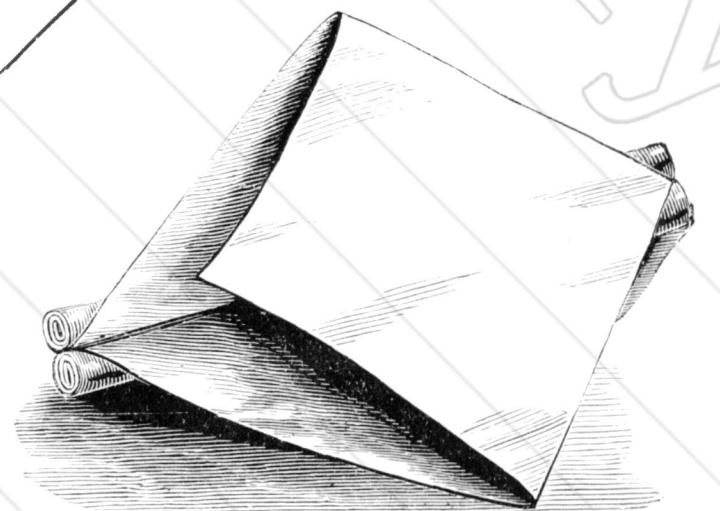

Fig. 5.

THE LEFT-HAND ROLL FOLDED OVER.



THE HOOD OR POCKET DESIGN.



Weldon's Fashion Magazines for Every Home

EDITED BY WOMEN.

EXCLUSIVELY FOR WOMEN:

Weldon's Ladies' Journal 3d.

Published on the 15th of every month. Every number contains Four or more Paper Patterns, a large Transfer Design of new Needlework, Artistic Fashions in Colours, Complete Story, Household Hints, Toilet, Etiquette, and a Host of Information of special interest to Ladies. Lessons in Home Dressmaking, Home Millinery, Hairdressing, Cookery, etc., each unexcelled of its kind. One Hundred Fashion Illustrations. The Practical Art of Cutting Out, Making, and Fitting all the Latest Fashions for Ladies and Children, with Quantity of Material required. A Wealth of Practical Articles, New and Fresh Ideas in every kind of Fancy Work, Valuable Recipes, etc.

Yearly Subscription, post free to any part of the World, 6s.; Canada, 4s. 4d. Single copy, post free, 6d.

Weldon's Illus. Dressmaker 1d.

Published on the 10th of each month. A Practical Guide to the Complete Art of Cutting Out, Fitting, and Making Ladies' Clothing. Every number contains One or more Paper Patterns, Fashions in Colours, How to Cut Out and Make all the Latest Fashions, Quantity of Material required, etc.

Yearly Subscription, post free to any part of the World, 2s. 9d. Canada, 2s. 2d. Single copy, post free, 2½d.

Weldon's Bazaar of Children's Fashions . 1d.

Published on the 10th of every month. A Guide to the Complete Art of Cutting Out, Fitting and Making Clothing for Boys, Girls, and Young Ladies. Every Number contains Two or more Paper Patterns of Children's Garments, a useful Transfer Design, Fashions in Colours, Quantity of Material required, etc.

Yearly Subscription, post free to any part of the World, 2s. 9d.; Canada, 2s. 2d. Single copy, post free, 2½d.

Weldon's Journal of Costumes . . 6d.

Published on the 15th of every month. Every number contains the same Letterpress, Illustrations, Paper Patterns, and Transfer Designs as in *Weldon's Ladies' Journal*, with Four additional Coloured Plates of Fashions. This edition is most artistically produced, and will be found in all the leading dressmaking establishments and salons.

Yearly Subscription, post free to any part of the World, 11s.; Canada, 8s. Single copy, post free, 10d.

Weldon's Shilling Cookery

For Moderate People with Moderate Incomes. New Edition. 696 Recipes. 100 Menus. 320 Pages. Lamp Cloth. Postage 2d.

Weldon's Sixpenny Cookery

Valuable Recipes for the Invalid, Nursery, and General Use, suitable for Every Household. Paper Cover. 160 Pages. Postage 2d.

Children's Lives and How to Protect Them

By Dr. WILLIAM LOMAS. Counsel to Parents on the Rearing of Children, the Prevention of Disease, and the Prompt Treatment of Children's Maladies. A useful volume for every Mother. Price 1s. Postage 2d.

Weldon's Guide to Fancy Work

Containing Elementary Instructions in Knitting, Stocking Knitting, Crochet, Crewel Work, Appliqué Work, Netting, Patchwork, Cross-Stitch, Macramé Lace, Smocking, Crochet Macramé, Bead Work, Mountmellick Work, Tatting, Canvas Braiding, Canvas Embroidery, Ivory Embroidery, Drawn-Thread Work, Crinkled Paper, Crochet d'Oyleys and Edgings, Point Lace, Honiton Lace, Bent-Iron Work, Torchon Lace, Tenerife Lace, Ribbon Work, Paper Flowers, Irish Crochet, Carrickmacross Lace, Embroidery Stitches, Filet Lace, Hardanger Embroidery, Americk Lace, Pillow Lace, Bead Chains and Necklets, Bead Curtains, Crochet Names and Initials, Hackaback Darning, Jacobean Work, Richelieu Embroidery, Punched Work, Rug-making, Raffle Work, Crochet and Knitted Coats, etc. Over 400 Engravings. Entirely New Edition (13th). Price 1s. Postage 3d.

Weldon's Guide to Folding Serviettes

1st Series: How to Fold Serviettes in 11 different ways. 2nd Series: How to Fold Serviettes in 13 different ways. Fully illustrated with Diagrams, etc. Price 2d. each. Postage 1d.

Weldon's Tracing Wheels

Invaluable to Home Dressmakers. Price 9d. each, postage 1d., with single wheel; or with double wheels, price 1s., postage 1d.

Weldon's Needlework Index

To Nos. 1 to 264 *Weldon's Practical Needlework*. Price 2d. Postage 3d. Ladies will find this Index an Invaluable Guide to Recipes on nearly every Article of Fancy Work.

Weldon's Crochet Initials

Complete Alphabet A to Z, with simple working directions. Price 2d. Postage 1d.

Weldon's Home Dressmaker 1d.

Published on the 25th of every month. A Practical Guide to the Complete Art of Home Dressmaking. Each number is complete and devoted to one subject of Dressmaking. Always in print. One or more Paper Patterns of the Dress-making Lesson given with every number.

Yearly Subscription, post free to any part of the World, 2s. The following numbers are always in print, One Penny each, post free, 2d.:—
Blouses and Bodices. Coats and Skirts.
Boys' Clothing. Infants' Clothing.
Ladies' Underclothing. Children's Underclothing.
Dressing Gowns. Pinafores and Aprons.
Evening Gowns, Mantles, etc.

Weldon's Home Milliner 1d.

Five numbers published yearly. Those ladies who superintend or undertake their own Millinery for pleasure or profit will find this publication a reliable guide and help, being a Practical Guide to the complete Art of Home Millinery.

Yearly Subscription, post free to any part of the World, 10d. Single copy, post free, 2d. Published as under—
January, March, May, September, November.

Weldon's Catalogue of Fashions . 3d.

Three numbers published yearly: Spring (March), Summer (May), and Autumn and Winter (October).

A collection of over 450 Designs of Coming Modes. All clever needlewomen should obtain this publication; it is a Complete Guide to Good Dressing. In addition to the Gratis Paper Patterns with every number, purchasers may select free any One Paper Pattern from many special designs.

Yearly Subscription, post free to any part of the World, 1s. 3d. Single copy, post free, 5d.

Weldon's Practical Needlework . . 2d.

Published on the 15th of every month. Each number is devoted to one subject of Fancy Work. Over 350 numbers now ready, and always in print. Beautifully illustrated, and practical working directions. A detailed list of the whole series sent free on application, comprising nearly 10,000 different recipes for Fancy Work.

Yearly Subscription, post free to any part of the World, 2s. 6d. Single copy, post free, 2½d.

Weldon's Transfer Designs

All one size, 20ins. x 20ins. All one price, 2d. each, by post 2½d. Every Weldon Transfer is enclosed in a green envelope, with complete working directions, what colours and stitches to use, how to adapt the design to several purposes, etc. A Sample Transfer post free, 2½d., or Six Designs, post free, 1s.

Stones of the Months

Giving a full and interesting account of the legend and lore of the correct birth-stone for each month of the year. This book interests everyone, and forms an excellent birthday gift. Cloth, 1s., or paper cover, 6d. Postage 1d.

Planets of the Months

Containing every detail of the planet for each month, with characteristics of persons born under each planet, giving their fortunate days, colours, lucky numbers, their flowers, etc. A more interesting book it would be difficult to find. Cloth, 1s., or paper cover, 6d. Postage 1d.

How to Tell Fortunes by the Cards

Price 6d. Post free, 7d. Eight explicit and fully illustrated methods of telling fortunes by cards for amusement, including the ancient Egyptian Tarot method, the fashionable Teulia Card fortune-teller; and "Fortune in the Teacup," "Crystal Gazing," etc. Much fun can be had by perusing this comprehensive fortune-telling book.

Weldon's 250 Ideas for Fancy Dresses

For Ladies, Children and Gentlemen. Practical Designs for Fancy Dress Balls, Carnivals, Skating Rink Costumes, Private Theatricals, School Plays, Minuets, Garden Fêtes, Pageants, Historical Plays, Characters from Shakespeare, Dickens, etc. Price 6d. Postage 2d.

Weldon's 400 Ideas for Art Needlework

An illustrated list of *Weldon's Transfer Designs* for Appliqué, Broderie Anglaise, Braiding, Bead Work, Chinese Subjects, Crewel Work, Cross-Stitch, Dresden Rose Work, Dutch Subjects, Embroidery, Initials, Jacobean, Japanese, Net Appliqué, Nursery Subjects, Oriental Subjects, Pen-Painting, Pastinello, Punched Work, Poker Work, Richelieu Embroidery, Stencilling, Venetian Embroidery, etc. Price 1d. Post free 2d.

Weldon's Pattern Book of 2,000 Styles

of everything you require for every occasion. Price 3d., by post 6d. A most useful book for every Dressmaker, whether for pleasure or profit. A Weldon Paper Pattern of any design illustrated always in stock, with full working directions, price 6d., by post, 7d.

WELDON'S, Ltd., Fashion, Paper Pattern and Transfer Publishers, 30-32, Southampton Street, Strand, London.